

Agilent InfiniiVision 7000 Series Oscilloscopes

Programmer's Guide



Agilent Technologies

Notices

© Agilent Technologies, Inc. 2005-2008

No part of this manual may be reproduced in any form or by any means (including electronic storage and retrieval or translation into a foreign language) without prior agreement and written consent from Agilent Technologies, Inc. as governed by United States and international copyright laws.

Trademarks

Microsoft®, MS-DOS®, Windows®, Windows 2000®, and Windows XP® are U.S. registered trademarks of Microsoft Corporation.

Adobe®, Acrobat®, and the Acrobat Logo® are trademarks of Adobe Systems Incorporated.

Manual Part Number

Version 05.20.0000

Edition

December 5, 2008

Available in electronic format only

Agilent Technologies, Inc.
1900 Garden of the Gods Road
Colorado Springs, CO 80907 USA

Warranty

The material contained in this document is provided “as is,” and is subject to being changed, without notice, in future editions. Further, to the maximum extent permitted by applicable law, Agilent disclaims all warranties, either express or implied, with regard to this manual and any information contained herein, including but not limited to the implied warranties of merchantability and fitness for a particular purpose. Agilent shall not be liable for errors or for incidental or consequential damages in connection with the furnishing, use, or performance of this document or of any information contained herein. Should Agilent and the user have a separate written agreement with warranty terms covering the material in this document that conflict with these terms, the warranty terms in the separate agreement shall control.

Technology Licenses

The hardware and/or software described in this document are furnished under a license and may be used or copied only in accordance with the terms of such license.

Restricted Rights Legend

If software is for use in the performance of a U.S. Government prime contract or sub-contract, Software is delivered and licensed as “Commercial computer software” as defined in DFAR 252.227-7014 (June 1995), or as a “commercial item” as defined in FAR 2.101(a) or as “Restricted computer software” as defined in FAR 52.227-19 (June 1987) or any equivalent

agency regulation or contract clause. Use, duplication or disclosure of Software is subject to Agilent Technologies’ standard commercial license terms, and non-DOD Departments and Agencies of the U.S. Government will receive no greater than Restricted Rights as defined in FAR 52.227-19(c)(1-2) (June 1987). U.S. Government users will receive no greater than Limited Rights as defined in FAR 52.227-14 (June 1987) or DFAR 252.227-7015 (b)(2) (November 1995), as applicable in any technical data.

Safety Notices

CAUTION

A **CAUTION** notice denotes a hazard. It calls attention to an operating procedure, practice, or the like that, if not correctly performed or adhered to, could result in damage to the product or loss of important data. Do not proceed beyond a **CAUTION** notice until the indicated conditions are fully understood and met.

WARNING

A **WARNING** notice denotes a hazard. It calls attention to an operating procedure, practice, or the like that, if not correctly performed or adhered to, could result in personal injury or death. Do not proceed beyond a **WARNING** notice until the indicated conditions are fully understood and met.

In This Book

This book is your guide to programming the 7000 Series oscilloscopes:

Table 1 InfiniiVision 7000 Series Oscilloscope Models

Channels	Input Bandwidth		
	1 GHz	500 MHz	300 MHz
4 analog + 16 digital (mixed-signal)	MSO7104A	MSO7054A	MSO7034A
2 analog + 16 digital (mixed-signal)		MSO7052A	MSO7032A
4 analog	DSO7104A	DSO7054A	DSO7034A
2 analog		DSO7052A	DSO7032A

The first few chapters describe how to set up and get started:

- Chapter 1, "[What's New](#)" on page 21, describes programming command changes in the latest version of oscilloscope software.
- Chapter 2, "[Setting Up](#)" on page 29, describes the steps you must take before you can program the oscilloscope.
- Chapter 3, "[Getting Started](#)" on page 39, gives a general overview of oscilloscope program structure and shows how to program the oscilloscope using a few simple examples.
- Chapter 4, "[Commands Quick Reference](#)" on page 53, is a brief listing of the 7000 Series oscilloscope commands and syntax.

The next chapters provide reference information:

- Chapter 5, "[Commands by Subsystem](#)" on page 103, describes the set of commands that belong to an individual subsystem and explains the function of each command. Command arguments and syntax are described. Some command descriptions have example code.
- Chapter 6, "[Commands A-Z](#)" on page 609, contains an alphabetical listing of all command elements.
- Chapter 7, "[Obsolete and Discontinued Commands](#)" on page 641, describes obsolete commands which still work but have been replaced by newer commands and discontinued commands which are no longer supported.
- Chapter 8, "[Error Messages](#)" on page 697, lists the instrument error messages that can occur while programming the oscilloscope.

The command descriptions in this reference show upper and lowercase characters. For example, :AUToscale indicates that the entire command name is :AUTOSCALE. The short form, :AUT, is also accepted by the oscilloscope.

Then, there are chapters that describe programming topics and conceptual information in more detail:

- Chapter 9, "[Status Reporting](#)" on page 705, describes the oscilloscope's status registers and how to check the status of the instrument.
- Chapter 10, "[Synchronizing Acquisitions](#)" on page 729, describes how to wait for acquisitions to complete before querying measurement results or performing other operations with the captured data.
- Chapter 11, "[More About Oscilloscope Commands](#)" on page 739, contains additional information about oscilloscope programming commands.

Finally, there is a chapter that contains programming examples:

- Chapter 12, "[Programming Examples](#)" on page 763.

Mixed-Signal Oscilloscope Channel Differences

Because both the "analog channels only" oscilloscopes (DSO models) and the mixed-signal oscilloscopes (MSO models) have analog channels, topics that describe analog channels refer to all oscilloscope models. Whenever a topic describes digital channels, that information applies only to the mixed-signal oscilloscope models.

See Also

- For more information on using the SICL, VISA, and VISA COM libraries in general, see the documentation that comes with the Agilent IO Libraries Suite.
- For information on controller PC interface configuration, see the documentation for the interface card used (for example, the Agilent 82350A GPIB interface).
- For information on oscilloscope front-panel operation, see the *User's Guide*.
- For detailed connectivity information, refer to the *Agilent Technologies USB/LAN/GPIB Connectivity Guide*. For a printable electronic copy of the *Connectivity Guide*, direct your Web browser to "www.agilent.com" and search for "Connectivity Guide".
- For the latest versions of this and other manuals, see: "<http://www.agilent.com/find/7000manual>"

Contents

In This Book 3

1 What's New

What's New in Version 5.20 22

What's New in Version 5.15 25

What's New in Version 5.10 27

Version 5.00 at Introduction 28

2 Setting Up

Step 1. Install Agilent IO Libraries Suite software 30

Step 2. Connect and set up the oscilloscope 31

Using the USB (Device) Interface 31

Using the LAN Interface 31

Step 3. Verify the oscilloscope connection 33

3 Getting Started

Basic Oscilloscope Program Structure 40

Initializing 40

Capturing Data 40

Analyzing Captured Data 41

Programming the Oscilloscope 42

Referencing the IO Library 42

Opening the Oscilloscope Connection via the IO Library 43

Initializing the Interface and the Oscilloscope 43

Using :AUToscale to Automate Oscilloscope Setup 44

Using Other Oscilloscope Setup Commands 44

Capturing Data with the :DIGitize Command 45

Reading Query Responses from the Oscilloscope 47

Reading Query Results into String Variables 48

Reading Query Results into Numeric Variables 48

Reading Definite-Length Block Query Response Data 48

Sending Multiple Queries and Reading Results 49

Checking Instrument Status 50

Other Ways of Sending Commands	51
Telnet Sockets	51
Sending SCPI Commands Using Browser Web Control	51

4 Commands Quick Reference

Command Summary	54
Syntax Elements	99
Number Format	99
<NL> (Line Terminator)	99
[] (Optional Syntax Terms)	99
{ } (Braces)	99
::= (Defined As)	99
<> (Angle Brackets)	100
... (Ellipsis)	100
n,...,p (Value Ranges)	100
d (Digits)	100
Quoted ASCII String	100
Definite-Length Block Response Data	100

5 Commands by Subsystem

Common (*) Commands	105
*CLS (Clear Status)	109
*ESE (Standard Event Status Enable)	110
*ESR (Standard Event Status Register)	112
*IDN (Identification Number)	114
*LRN (Learn Device Setup)	115
*OPC (Operation Complete)	116
*OPT (Option Identification)	117
*RCL (Recall)	119
*RST (Reset)	120
*SAV (Save)	123
*SRE (Service Request Enable)	124
*STB (Read Status Byte)	126
*TRG (Trigger)	128
*TST (Self Test)	129
*WAI (Wait To Continue)	130
Root (:) Commands	131
:ACTivity	134
:AER (Arm Event Register)	135
:AUToscale	136

:AUToscale:AMODE	138
:AUToscale:CHANnels	139
:BLANK	140
:CDISplay	141
:DIGitize	142
:HWEenable (Hardware Event Enable Register)	144
:HWERegister:CONDition (Hardware Event Condition Register)	146
:HWERegister[:EVENT] (Hardware Event Event Register)	148
:MERGe	150
:MTEenable (Mask Test Event Enable Register)	151
:MTERegister[:EVENT] (Mask Test Event Event Register)	153
:OPEE (Operation Status Enable Register)	155
:OPERRegister:CONDition (Operation Status Condition Register)	157
:OPERRegister[:EVENT] (Operation Status Event Register)	159
:OVLenable (Overload Event Enable Register)	161
:OVLRegister (Overload Event Register)	163
:PRINt	165
:RUN	166
:SERial	167
:SINGle	168
:STATus	169
:STOP	170
:TER (Trigger Event Register)	171
:VIEW	172
:ACQuire Commands	173
:ACQuire:AALias	175
:ACQuire:COMPLete	176
:ACQuire:COUNT	177
:ACQuire:DAALias	178
:ACQuire:MODE	179
:ACQuire:POINts	180
:ACQuire:RSIGNal	181
:ACQuire:SEGMENTed:ANALyze	182
:ACQuire:SEGMENTed:COUNT	183
:ACQuire:SEGMENTed:INDex	184
:ACQuire:SRATe	187
:ACQuire:TYPE	188
:BUS<n> Commands	190
:BUS<n>:BIT<m>	192
:BUS<n>:BITS	193
:BUS<n>:CLEar	195

:BUS<n>:DISPlay	196
:BUS<n>:LABel	197
:BUS<n>:MASK	198
:CALibrate Commands	199
:CALibrate:DATE	201
:CALibrate:LABel	202
:CALibrate:OUTPut	203
:CALibrate:STARt	204
:CALibrate:STATus	205
:CALibrate:SWITCh	206
:CALibrate:TEMPerature	207
:CALibrate:TIME	208
:CHANnel<n> Commands	209
:CHANnel<n>:BWLimit	212
:CHANnel<n>:COUPling	213
:CHANnel<n>:DISPlay	214
:CHANnel<n>:IMPedance	215
:CHANnel<n>:INVert	216
:CHANnel<n>:LABel	217
:CHANnel<n>:OFFSet	218
:CHANnel<n>:PROBe	219
:CHANnel<n>:PROBe:ID	220
:CHANnel<n>:PROBe:SKEW	221
:CHANnel<n>:PROBe:STYPe	222
:CHANnel<n>:PROTection	223
:CHANnel<n>:RANGe	224
:CHANnel<n>:SCALe	225
:CHANnel<n>:UNITs	226
:CHANnel<n>:VERNier	227
:DIGital<n> Commands	228
:DIGital<n>:DISPlay	230
:DIGital<n>:LABel	231
:DIGital<n>:POSition	232
:DIGital<n>:SIZE	233
:DIGital<n>:THReshold	234
:DISPlay Commands	235
:DISPlay:CLEar	237
:DISPlay:DATA	238
:DISPlay:LABel	240
:DISPlay:LABList	241

:DISPlay:PERsistence	242
:DISPlay:SOURce	243
:DISPlay:VECTors	244
:EXTErnal Trigger Commands	245
:EXTErnal:BWLimit	247
:EXTErnal:IMPedance	248
:EXTErnal:PROBe	249
:EXTErnal:PROBe:ID	250
:EXTErnal:PROBe:STYPe	251
:EXTErnal:PROTEction	252
:EXTErnal:RANGe	253
:EXTErnal:UNITs	254
:FUNCTion Commands	255
:FUNCTion:CENTer	258
:FUNCTion:DISPlay	259
:FUNCTion:GOFT:OPERation	260
:FUNCTion:GOFT:SOURce1	261
:FUNCTion:GOFT:SOURce2	262
:FUNCTion:OFFSet	263
:FUNCTion:OPERation	264
:FUNCTion:RANGe	265
:FUNCTion:REFerence	266
:FUNCTion:SCALE	267
:FUNCTion:SOURce1	268
:FUNCTion:SOURce2	269
:FUNCTion:SPAN	270
:FUNCTion:WINDow	271
:HARDcopy Commands	272
:HARDcopy:AREA	274
:HARDcopy:APRinter	275
:HARDcopy:FACTors	276
:HARDcopy:FFEed	277
:HARDcopy:INKSaver	278
:HARDcopy:LAYout	279
:HARDcopy:PALette	280
:HARDcopy:PRINter:LIST	281
:HARDcopy:START	282
:MARKer Commands	283
:MARKer:MODE	285
:MARKer:X1Position	286

:MARKer:X1Y1source	287
:MARKer:X2Position	288
:MARKer:X2Y2source	289
:MARKer:XDELta	290
:MARKer:Y1Position	291
:MARKer:Y2Position	292
:MARKer:YDELta	293
:MEASure Commands	294
:MEASure:CLEar	302
:MEASure:COUNter	303
:MEASure:DEFine	304
:MEASure:DELay	307
:MEASure:DUTYcycle	309
:MEASure:FALLtime	310
:MEASure:FREQuency	311
:MEASure:NWIDth	312
:MEASure:OVERshoot	313
:MEASure:PERiod	315
:MEASure:PHASe	316
:MEASure:PREShoot	317
:MEASure:PWIDth	318
:MEASure:RESults	319
:MEASure:RISetime	322
:MEASure:SDEViation	323
:MEASure:SHOW	324
:MEASure:SOURce	325
:MEASure:STATistics	327
:MEASure:STATistics:INCRement	328
:MEASure:STATistics:RESet	329
:MEASure:TEDGE	330
:MEASure:TVALue	332
:MEASure:VAMPLitude	334
:MEASure:VAverage	335
:MEASure:VBASe	336
:MEASure:VMAX	337
:MEASure:VMIN	338
:MEASure:VPP	339
:MEASure:VRATio	340
:MEASure:VRMS	341
:MEASure:VTIME	342
:MEASure:VTOP	343

:MEASure:XMAX	344
:MEASure:XMIN	345
:MTESt Commands	346
:MTESt:AMASk:CREate	351
:MTESt:AMASk:SOURce	352
:MTESt:AMASk:UNITs	353
:MTESt:AMASk:XDELta	354
:MTESt:AMASk:YDELta	355
:MTESt:COUNt:FWAVEforms	356
:MTESt:COUNt:RESet	357
:MTESt:COUNt:TIME	358
:MTESt:COUNt:WAVEforms	359
:MTESt:DATA	360
:MTESt:DELeTe	361
:MTESt:ENABle	362
:MTESt:LOCK	363
:MTESt:OUTPut	364
:MTESt:RMODe	365
:MTESt:RMODe:FACTion:PRINt	366
:MTESt:RMODe:FACTion:SAVE	367
:MTESt:RMODe:FACTion:STOP	368
:MTESt:RMODe:SIGMa	369
:MTESt:RMODe:TIME	370
:MTESt:RMODe:WAVEforms	371
:MTESt:SCALe:BIND	372
:MTESt:SCALe:X1	373
:MTESt:SCALe:XDELta	374
:MTESt:SCALe:Y1	375
:MTESt:SCALe:Y2	376
:MTESt:SOURce	377
:MTESt:TITLe	378
:POD Commands	379
:POD<n>:DISPlay	380
:POD<n>:SIZE	381
:POD<n>:THReshold	382
:RECall Commands	384
:RECall:FILename	385
:RECall:IMAGe[:START]	386
:RECall:MASK[:START]	387
:RECall:PWD	388

:RECall:SETup[:START]	389
:SAVE Commands	390
:SAVE:FILEName	392
:SAVE:IMAGe[:START]	393
:SAVE:IMAGe:AREA	394
:SAVE:IMAGe:FACTors	395
:SAVE:IMAGe:FORMat	396
:SAVE:IMAGe:INKSaver	397
:SAVE:IMAGe:PALette	398
:SAVE:MASK[:START]	399
:SAVE:PWD	400
:SAVE:SETup[:START]	401
:SAVE:WAVeform[:START]	402
:SAVE:WAVeform:FORMat	403
:SAVE:WAVeform:LENGth	404
:SAVE:WAVeform:SEGmented	405
:SBUS Commands	406
:SBUS:BUSDoctor:ADDReSS	409
:SBUS:BUSDoctor:BAUDrate	410
:SBUS:BUSDoctor:CHANnel	411
:SBUS:BUSDoctor:MODE	412
:SBUS:CAN:COUNT:ERRor	413
:SBUS:CAN:COUNT:OVERload	414
:SBUS:CAN:COUNT:RESet	415
:SBUS:CAN:COUNT:TOTal	416
:SBUS:CAN:COUNT:UTILization	417
:SBUS:DISPlay	418
:SBUS:FLEXray:COUNT:NULL	419
:SBUS:FLEXray:COUNT:RESet	420
:SBUS:FLEXray:COUNT:SYNC	421
:SBUS:FLEXray:COUNT:TOTal	422
:SBUS:IIC:ASIZe	423
:SBUS:LIN:PARity	424
:SBUS:MODE	425
:SBUS:SPI:WIDTh	426
:SBUS:UART:BASE	427
:SBUS:UART:COUNT:ERRor	428
:SBUS:UART:COUNT:RESet	429
:SBUS:UART:COUNT:RXFRames	430
:SBUS:UART:COUNT:TXFRames	431
:SBUS:UART:FRAMing	432

:SYSTem Commands	433
:SYSTem:DATE	434
:SYSTem:DSP	435
:SYSTem:ERRor	436
:SYSTem:LOCK	437
:SYSTem:PROTection:LOCK	438
:SYSTem:SETup	439
:SYSTem:TIME	441
:TIMebase Commands	442
:TIMebase:MODE	444
:TIMebase:POSition	445
:TIMebase:RANGe	446
:TIMebase:REFClock	447
:TIMebase:REFerence	448
:TIMebase:SCALE	449
:TIMebase:VERNier	450
:TIMebase:WINDow:POSition	451
:TIMebase:WINDow:RANGe	452
:TIMebase:WINDow:SCALE	453
:TRIGger Commands	454
General :TRIGger Commands	457
:TRIGger:HFReject	458
:TRIGger:HOLDoff	459
:TRIGger:MODE	460
:TRIGger:NREJect	461
:TRIGger:PATTern	462
:TRIGger:SWEEp	464
:TRIGger:CAN Commands	465
:TRIGger:CAN:PATTern:DATA	467
:TRIGger:CAN:PATTern:DATA:LENGth	468
:TRIGger:CAN:PATTern:ID	469
:TRIGger:CAN:PATTern:ID:MODE	470
:TRIGger:CAN:SAMPlepoint	471
:TRIGger:CAN:SIGNal:BAUDrate	472
:TRIGger:CAN:SOURce	473
:TRIGger:CAN:TRIGger	474
:TRIGger:DURation Commands	476
:TRIGger:DURation:GREaterthan	477
:TRIGger:DURation:LESSthan	478
:TRIGger:DURation:PATTern	479
:TRIGger:DURation:QUALifier	480

:TRIGger:DURation:RANGe	481
:TRIGger:EBURst Commands	482
:TRIGger:EBURst:COUNt	483
:TRIGger:EBURst:IDLE	484
:TRIGger:EBURst:SLOPe	485
:TRIGger[:EDGE] Commands	486
:TRIGger[:EDGE]:COUPling	487
:TRIGger[:EDGE]:LEVel	488
:TRIGger[:EDGE]:REJect	489
:TRIGger[:EDGE]:SLOPe	490
:TRIGger[:EDGE]:SOURce	491
:TRIGger:FLEXray Commands	492
:TRIGger:FLEXray:ERRor:TYPE	493
:TRIGger:FLEXray:FRAMe:CCBase	495
:TRIGger:FLEXray:FRAMe:CCRepetition	496
:TRIGger:FLEXray:FRAMe:ID	497
:TRIGger:FLEXray:FRAMe:TYPE	498
:TRIGger:FLEXray:TIME:CBASe	499
:TRIGger:FLEXray:TIME:CREPetition	500
:TRIGger:FLEXray:TIME:SEGMENT	501
:TRIGger:FLEXray:TIME:SLOT	502
:TRIGger:FLEXray:TRIGger	503
:TRIGger:GLITch Commands	504
:TRIGger:GLITch:GREaterthan	506
:TRIGger:GLITch:LESSthan	507
:TRIGger:GLITch:LEVel	508
:TRIGger:GLITch:POLarity	509
:TRIGger:GLITch:QUALifier	510
:TRIGger:GLITch:RANGe	511
:TRIGger:GLITch:SOURce	512
:TRIGger:IIC Commands	513
:TRIGger:IIC:PATtern:ADDRes	514
:TRIGger:IIC:PATtern:DATA	515
:TRIGger:IIC:PATtern:DATA2	516
:TRIGger:IIC[:SOURce]:CLOCK	517
:TRIGger:IIC[:SOURce]:DATA	518
:TRIGger:IIC:TRIGger:QUALifier	519
:TRIGger:IIC:TRIGger[:TYPE]	520
:TRIGger:LIN Commands	522
:TRIGger:LIN:ID	523
:TRIGger:LIN:SAMPLepoint	524
:TRIGger:LIN:SIGNal:BAUDrate	525

:TRIGger:LIN:SOURce	526
:TRIGger:LIN:STANdard	527
:TRIGger:LIN:SYNCbreak	528
:TRIGger:LIN:TRIGger	529
:TRIGger:SEQuence Commands	530
:TRIGger:SEQuence:COUNt	531
:TRIGger:SEQuence:EDGE	532
:TRIGger:SEQuence:FIND	533
:TRIGger:SEQuence:PATtern	534
:TRIGger:SEQuence:RESet	535
:TRIGger:SEQuence:TIMer	536
:TRIGger:SEQuence:TRIGger	537
:TRIGger:SPI Commands	538
:TRIGger:SPI:CLOCK:SLOPe	539
:TRIGger:SPI:CLOCK:TIMeout	540
:TRIGger:SPI:FRAMing	541
:TRIGger:SPI:PATtern:DATA	542
:TRIGger:SPI:PATtern:WIDTh	543
:TRIGger:SPI:SOURce:CLOCK	544
:TRIGger:SPI:SOURce:DATA	545
:TRIGger:SPI:SOURce:FRAMe	546
:TRIGger:TV Commands	547
:TRIGger:TV:LINE	548
:TRIGger:TV:MODE	549
:TRIGger:TV:POLarity	550
:TRIGger:TV:SOURce	551
:TRIGger:TV:STANdard	552
:TRIGger:UART Commands	553
:TRIGger:UART:BASE	555
:TRIGger:UART:BAUDrate	556
:TRIGger:UART:BITorder	557
:TRIGger:UART:BURSt	558
:TRIGger:UART:DATA	559
:TRIGger:UART:IDLE	560
:TRIGger:UART:PARity	561
:TRIGger:UART:POLarity	562
:TRIGger:UART:QUALifier	563
:TRIGger:UART:SOURce:RX	564
:TRIGger:UART:SOURce:TX	565
:TRIGger:UART:TYPE	566
:TRIGger:UART:WIDTh	567
:TRIGger:USB Commands	568

:TRIGger:USB:SOURce:DMINus	569
:TRIGger:USB:SOURce:DPLus	570
:TRIGger:USB:SPEEd	571
:TRIGger:USB:TRIGger	572
:WAVeform Commands	573
:WAVeform:BYTeorder	581
:WAVeform:COUNt	582
:WAVeform:DATA	583
:WAVeform:FORMat	585
:WAVeform:POINts	586
:WAVeform:POINts:MODE	588
:WAVeform:PREamble	590
:WAVeform:SEGMented:COUNt	593
:WAVeform:SEGMented:TTAG	594
:WAVeform:SOURce	595
:WAVeform:SOURce:SUBSource	599
:WAVeform:TYPE	600
:WAVeform:UNSigned	601
:WAVeform:VIEW	602
:WAVeform:XINCrement	603
:WAVeform:XORigin	604
:WAVeform:XREFerence	605
:WAVeform:YINCrement	606
:WAVeform:YORigin	607
:WAVeform:YREFerence	608

6 Commands A-Z

7 Obsolete and Discontinued Commands

:CHANnel:ACTivity	646
:CHANnel:LABel	647
:CHANnel:THReshold	648
:CHANnel2:SKEW	649
:CHANnel<n>:INPut	650
:CHANnel<n>:PMODE	651
:DISPlay:CONNect	652
:DISPlay:ORDer	653
:ERASe	654
:EXTernal:INPut	655
:EXTernal:PMODE	656
:FUNCTion:SOURce	657

:FUNction:VIEW	658
:HARDcopy:DESTination	659
:HARDcopy:DEvice	660
:HARDcopy:FILEname	661
:HARDcopy:FORMat	662
:HARDcopy:GRAYscale	663
:HARDcopy:IGColors	664
:HARDcopy:PDriver	665
:MEASure:LOWer	666
:MEASure:SCRatch	667
:MEASure:TDELta	668
:MEASure:THResholds	669
:MEASure:TMAX	670
:MEASure:TMIN	671
:MEASure:TStArt	672
:MEASure:TStOp	673
:MEASure:TVOLt	674
:MEASure:UPPer	676
:MEASure:VDELta	677
:MEASure:VStArt	678
:MEASure:VStOp	679
:MTESt:AMASk:{SAVE StORe}	680
:MTESt:AVERage	681
:MTESt:AVERage:COUNt	682
:MTESt:LOAD	683
:MTESt:RUMode	684
:MTESt:RUMode:SOFailure	685
:MTESt:{StARt StOP}	686
:MTESt:TRIGger:SOURce	687
:PRINt?	688
:TIMebase:DELay	690
:TRIGger:CAN:ACKNowledge	691
:TRIGger:CAN:SIGNal:DEFinition	692
:TRIGger:LIN:SIGNal:DEFinition	693
:TRIGger:THReshold	694
:TRIGger:TV:TVMODE	695

8 Error Messages

9 Status Reporting

Status Reporting Data Structures	708
----------------------------------	-----

Status Byte Register (STB)	711
Service Request Enable Register (SRE)	713
Trigger Event Register (TER)	714
Output Queue	715
Message Queue	716
(Standard) Event Status Register (ESR)	717
(Standard) Event Status Enable Register (ESE)	718
Error Queue	719
Operation Status Event Register (:OPERegister[:EVENT])	720
Operation Status Condition Register (:OPERegister:CONDition)	721
Arm Event Register (AER)	722
Overload Event Register (:OVLRegister)	723
Hardware Event Event Register (:HWERegister[:EVENT])	724
Hardware Event Condition Register (:HWERegister:CONDition)	725
Mask Test Event Event Register (:MTERegister[:EVENT])	726
Clearing Registers and Queues	727
Status Reporting Decision Chart	728

10 Synchronizing Acquisitions

Synchronization in the Programming Flow	730
Set Up the Oscilloscope	730
Acquire a Waveform	730
Retrieve Results	730
Blocking Synchronization	731
Polling Synchronization With Timeout	732
Synchronizing with a Single-Shot Device Under Test (DUT)	734
Synchronization with an Averaging Acquisition	736

11 More About Oscilloscope Commands

Command Classifications	740
Core Commands	740
Non-Core Commands	740
Obsolete Commands	740

Valid Command/Query Strings	741
Program Message Syntax	741
Command Tree	745
Duplicate Mnemonics	758
Tree Traversal Rules and Multiple Commands	759
Query Return Values	761
All Oscilloscope Commands Are Sequential	762

12 Programming Examples

SICL Examples	764
SICL Example in C	764
SICL Example in Visual Basic	773
VISA Examples	782
VISA Example in C	782
VISA Example in Visual Basic	791
VISA Example in C#	801
VISA Example in Visual Basic .NET	815
VISA COM Examples	828
VISA COM Example in Visual Basic	828
VISA COM Example in C#	838
VISA COM Example in Visual Basic .NET	849

Index



1

What's New

What's New in Version 5.20	22
What's New in Version 5.15	25
What's New in Version 5.10	27
Version 5.00 at Introduction	28



What's New in Version 5.20

New features in version 5.20 of the InfiniiVision 7000 Series oscilloscope software are:

- Mask testing, enabled with Option LMT.
- Tracking cursors (markers) have been added.
- Measurement statistics have been added.
- Labels can now be up to 10 characters.

More detailed descriptions of the new and changed commands appear below.

New Commands

Command	Description
:ACQuire:SEGmented:ANALyze (see page 182)	Calculates measurement statistics and/or infinite persistence over all segments that have been acquired.
:CALibrate:OUTPut (see page 203)	Selects the signal output on the rear panel TRIG OUT BNC.
:HARDcopy:LAYout (see page 279)	Sets the hardcopy layout mode.
:MEASure:RESults (see page 319)	Returns measurement statistics values.
:MEASure:STATistics (see page 327)	Sets the type of measurement statistics to return.
:MEASure:STATistics:INCRement (see page 328)	Updates the statistics once (incrementing the count by one) using the current measurement values.
:MEASure:STATistics:RESet (see page 329)	Resets the measurement statistics values.
:MTEenable (Mask Test Event Enable Register) (see page 151)	Sets a mask in the Mask Test Event Enable register.
:MTEregister[:EVENT] (Mask Test Event Event Register) (see page 153)	Returns the integer value contained in the Mask Test Event Event Register and clears the register.
:MTESt Commands (see page 346)	Commands and queries to control the mask test (Option LMT) features.
:RECall:MASK[:START] (see page 399)	Recalls a mask.
:SAVE:MASK[:START] (see page 399)	Saves the current mask.
:SAVE:WAVEform:SEGmented (see page 405)	Specifies which segments are included when the waveform is saved.
:TRIGger:UART:BASE (see page 555)	Selects the front panel UART/RS232 trigger setup data selection option from HEX or BINary.

Changed Commands

Command	Differences
:BUS<n>:LABel (see page 197)	Labels can now be up to 10 characters.
:CHANnel<n>:LABel (see page 217)	Labels can now be up to 10 characters.
:DIGital<n>:LABel (see page 231)	Labels can now be up to 10 characters.
:DISPlay:LABList (see page 241)	Labels can now be up to 10 characters.
:MARKer:MODE (see page 285)	You can now select the WAVEform tracking cursors mode.
:RECall:PWD (see page 388)	You can set the present working directory in addition to querying for this information.
:SAVE:IMAGe[:START] (see page 393)	The file extension specified will change the :SAVE:IMAGe:FORMat setting if it is a valid image file extension.
:SAVE:PWD (see page 400)	You can set the present working directory in addition to querying for this information.
:SAVE:WAVEform[:START] (see page 393)	The file extension specified will change the :SAVE:WAVEform:FORMat setting if it is a valid waveform file extension.
:TRIGger:CAN:SIGNal:BAUDrate (see page 472)	The baud rate value can now be set in 100 b/s increments.
:TRIGger:LIN:SIGNal:BAUDrate (see page 525)	The baud rate value can now be set in 100 b/s increments.
:TRIGger:UART:BAUDrate (see page 556)	The baud rate value can now be set in 100 b/s increments and the maximum baud rate is now 3 Mb/s.
:TRIGger:UART:DATA (see page 559)	You can now specify the data value using a quoted ASCII character.

Obsolete Commands

Obsolete Command	Current Command Equivalent	Behavior Differences
:MTESt:AMASK:{SAVE STORE} (see page 680)	:SAVE:MASK[:START] (see page 399)	
:MTESt:AVERage (see page 681)	:ACQuire:TYPE AVERage (see page 188)	
:MTESt:AVERage:COUNt (see page 682)	:ACQuire:COUNt (see page 177)	
:MTESt:LOAD (see page 683)	:RECall:MASK[:START] (see page 387)	
:MTESt:RUMode (see page 684)	:MTESt:RMODE (see page 365)	

1 What's New

Obsolete Command	Current Command Equivalent	Behavior Differences
:MTESt:RUMode:SOFailure (see page 685)	:MTESt:RMODE:FACTion:STOP (see page 368)	
:MTESt:{START STOP} (see page 686)	:RUN (see page 166) or :STOP (see page 170)	
:MTESt:TRIGger:SOURce (see page 687)	:TRIGger Commands (see page 454)	There are various commands for setting the source with different types of triggers.

What's New in Version 5.15

New features in version 5.15 of the InfiniiVision 7000 Series oscilloscope software are:

- Waveform math can be performed using channels 3 and 4, and there is a new ADD operator.
- Ratio of AC RMS values measurement.
- Analog channel impedance protection lock.

More detailed descriptions of the new and changed commands appear below.

New Commands

Command	Description
:FUNction:GOFT:OPERation (see page 260)	Selects the math operation for the internal g(t) source that can be used as the input to the FFT, INTegrate, DIFFerentiate, and SQRT functions.
:FUNction:GOFT:SOURce1 (see page 261)	Selects the first input channel for the g(t) source.
:FUNction:GOFT:SOURce2 (see page 262)	Selects the second input channel for the g(t) source.
:FUNction:SOURce1 (see page 268)	Selects the first source for the ADD, SUBTract, and MULTiPLY arithmetic operations or the single source for the FFT, INTegrate, DIFFerentiate, and SQRT functions.
:FUNction:SOURce2 (see page 269)	Selects the second input channel for the ADD, SUBTract, and MULTiPLY arithmetic operations.
:MEASure:VRATio (see page 340)	Measures and returns the ratio of AC RMS values of the specified sources expressed in dB.
:SYSTem:PROTection:LOCK (see page 438)	Disables/enables the fifty ohm input impedance setting.

1 What's New

Changed Commands

Command	Differences
:ACQuire:COUNt (see page 177)	The :ACQuire:COUNt 1 command has been deprecated. The AVERage acquisition type with a count of 1 is functionally equivalent to the HRESolution acquisition type; however, you should select the high-resolution acquisition mode with the :ACQuire:TYPE HRESolution command instead.
:FUNction:OPERation (see page 264)	The ADD parameter is new, and now that waveform math can be performed using channels 3 and 4, this command selects the operation only.
:FUNction:WINDow (see page 271)	You can now select the Blackman-Harris FFT window.

Obsolete Commands

Obsolete Command	Current Command Equivalent	Behavior Differences
:FUNction:SOURce (see page 657)	:FUNction:SOURce1 (see page 268)	Obsolete command has ADD, SUBTract, and MULTIpLy parameters; current command has GOFT parameter.

What's New in Version 5.10

New features in version 5.10 of the InfiniiVision 7000 Series oscilloscope software are:

- Segmented memory acquisition mode, enabled with Option SGM.

More detailed descriptions of the new and changed commands appear below.

New Commands

Command	Description
:ACQuire:SEGMented:COUNt (see page 183)	Sets the number of memory segments.
:ACQuire:SEGMented:INDex (see page 184)	Selects the segmented memory index.
:WAVeform:SEGMented:COUNt (see page 593)	Returns the number of segments in the currently acquired waveform data.
:WAVeform:SEGMented:TTAG (see page 594)	Returns the time tag for the selected segmented memory index.

Changed Commands

Command	Differences
:ACQuire:MODE (see page 179)	You can now select the SEGMented memory mode.

Version 5.00 at Introduction

The Agilent InfiniiVision 7000 Series oscilloscopes were introduced with version 5.00 of oscilloscope operating software. The command set is based on the 6000 Series oscilloscopes (and the 54620/54640 Series oscilloscopes before them).



2 Setting Up

- Step 1. Install Agilent IO Libraries Suite software 30
- Step 2. Connect and set up the oscilloscope 31
- Step 3. Verify the oscilloscope connection 33

This chapter explains how to install the Agilent IO Libraries Suite software, connect the oscilloscope to the controller PC, set up the oscilloscope, and verify the oscilloscope connection.



Step 1. Install Agilent IO Libraries Suite software

Insert the Automation-Ready CD that was shipped with your oscilloscope into the controller PC's CD-ROM drive, and follow its installation instructions.

You can also download the Agilent IO Libraries Suite software from the web at:

- "<http://www.agilent.com/find/iolib>"

Step 2. Connect and set up the oscilloscope

The 7000 Series oscilloscope has two different interfaces you can use for programming: USB (device) or LAN.

Both interfaces are "live" by default, but you can turn them off if desired. To access these settings press the **Utility** key on the front panel, then press the **I/O** softkey, then press the **Control** softkey.

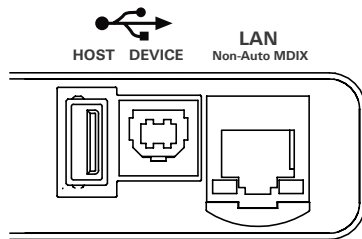

Figure 1 Control Connectors on Rear Panel

Using the USB (Device) Interface

- 1 Connect a USB cable from the controller PC's USB port to the "USB DEVICE" port on the back of the oscilloscope.

This is a USB 2.0 high-speed port.

- 2 On the oscilloscope, verify that the controller interface is enabled:
 - a Press the **Utility** button.
 - b Using the softkeys, press **I/O** and **Control**.
 - c Ensure the box next to **USB** is selected (). If not () use the Entry knob to select **USB**; then, press the **Control** softkey again.

Using the LAN Interface

- 1 If the controller PC isn't already connected to the local area network (LAN), do that first.
- 2 Get the oscilloscope's network parameters (hostname, domain, IP address, subnet mask, gateway IP, DNS IP, etc.) from your network administrator.
- 3 Connect the oscilloscope to the local area network (LAN) by inserting LAN cable into the "LAN" port on the back of the oscilloscope.

- 4 On the oscilloscope, verify that the controller interface is enabled:
 - a Press the **Utility** button.
 - b Using the softkeys, press **I/O** and **Control**.
 - c Ensure the box next to **LAN** is selected (■). If not (□), use the Entry knob to select **LAN**; then, press the **Control** softkey again.
- 5 Configure the oscilloscope's LAN interface:
 - a Press the **Configure** softkey until "LAN" is selected.
 - b Press the **LAN Settings** softkey.
 - c Press the **Addresses** softkey. Use the **IP Options** softkey and the Entry knob to select DHCP, AutoIP, or netBIOS. Use the **Modify** softkey (and the other softkeys and the Entry knob) to enter the IP Address, Subnet Mask, Gateway IP, and DNS IP values. When you are done, press the return (up arrow) softkey.
 - d Press the **Domain** softkey. Use the **Modify** softkey (and the other softkeys and the Entry knob) to enter the Host name and the Domain name. When you are done, press the return (up arrow) softkey.

Step 3. Verify the oscilloscope connection

- 1 On the controller PC, click on the Agilent IO Control icon in the taskbar and choose **Agilent Connection Expert** from the popup menu.

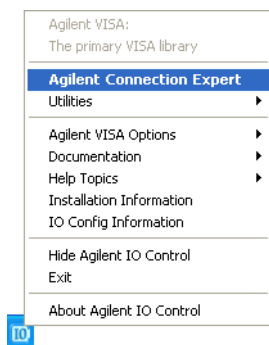

- 2 In the Agilent Connection Expert application, instruments connected to the controller's USB and GPIB interfaces should automatically appear. (You can click Refresh All to update the list of instruments on these interfaces.)

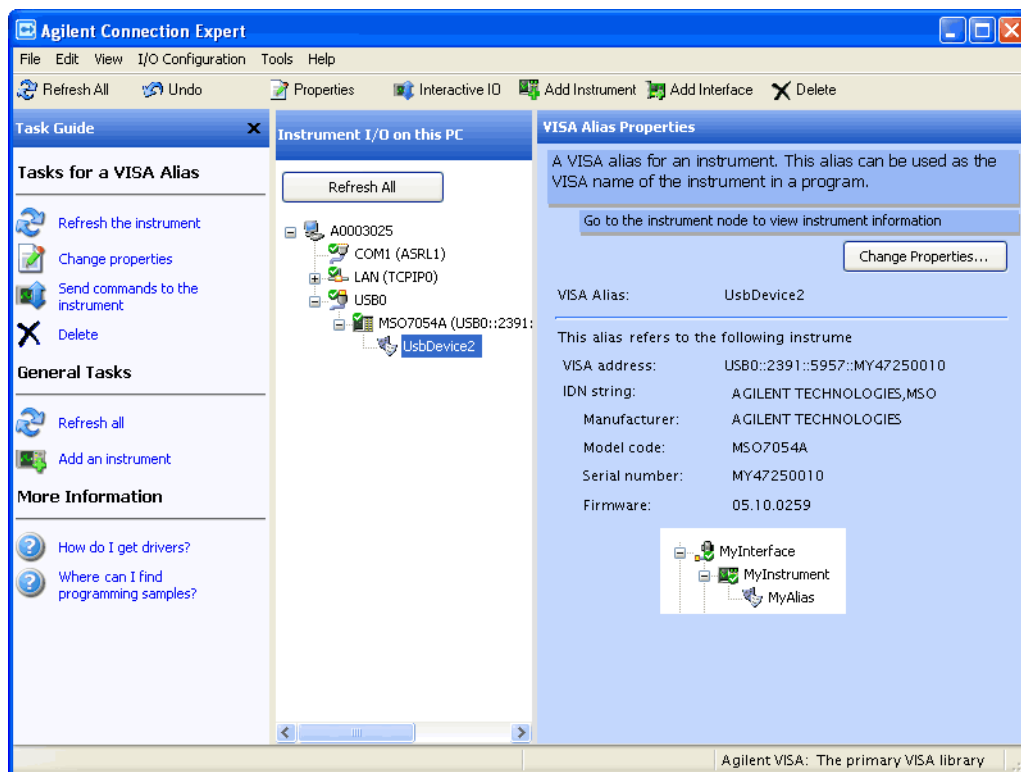

2 Setting Up

You must manually add instruments on LAN interfaces:

- a Right-click on the LAN interface, choose **Add Instrument** from the popup menu

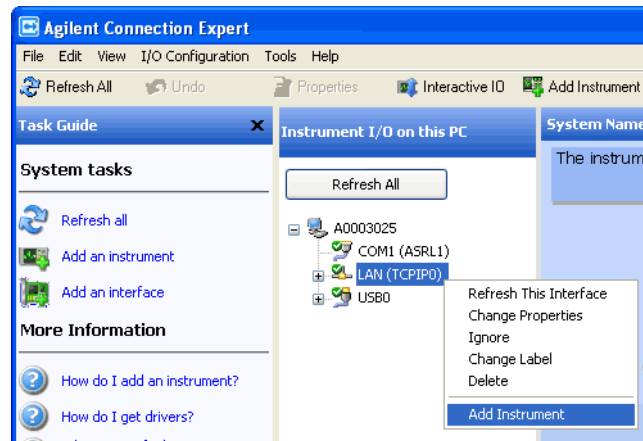

- b If the oscilloscope is on the same subnet, select it, and click **OK**.

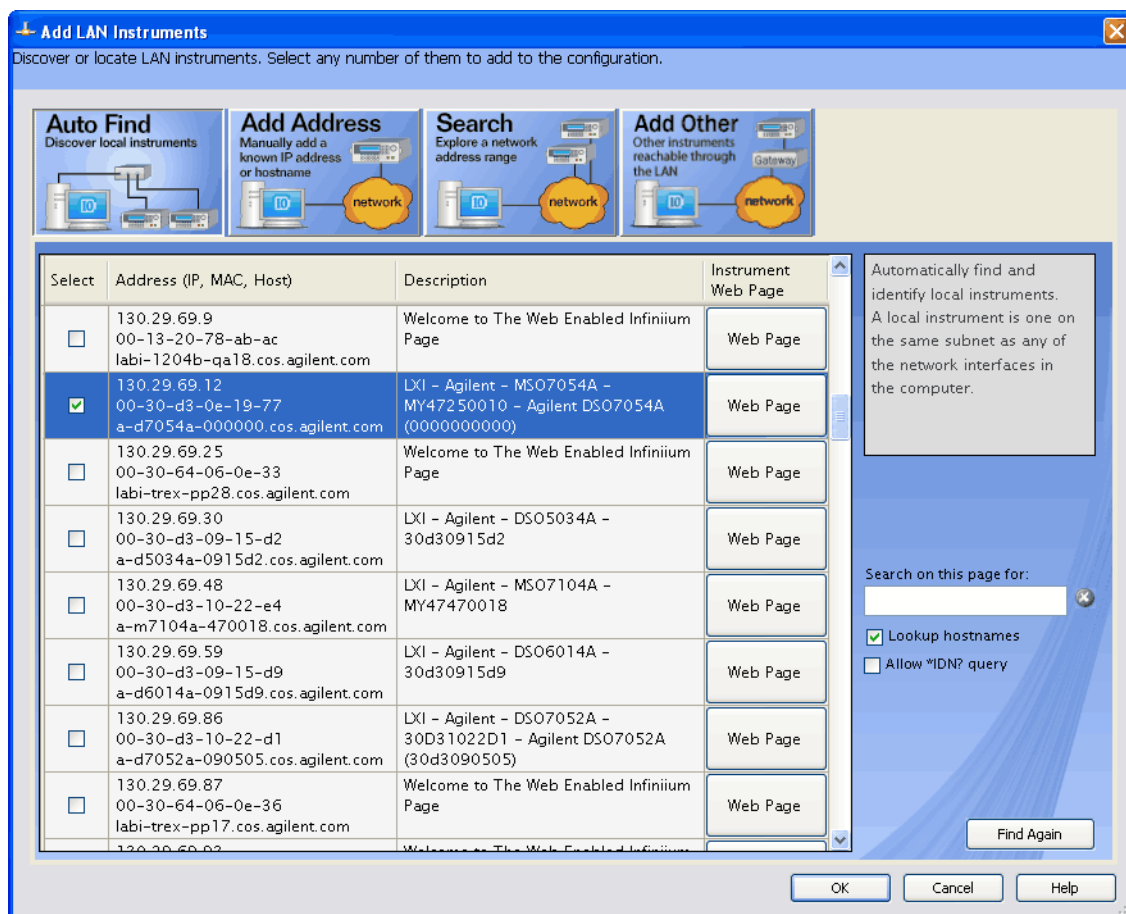

Otherwise, if the instrument is not on the same subnet, click **Add Address**.

- i In the next dialog, select either **Hostname** or **IP address**, and enter the oscilloscope's hostname or IP address.
- ii Click **Test Connection**.

2 Setting Up

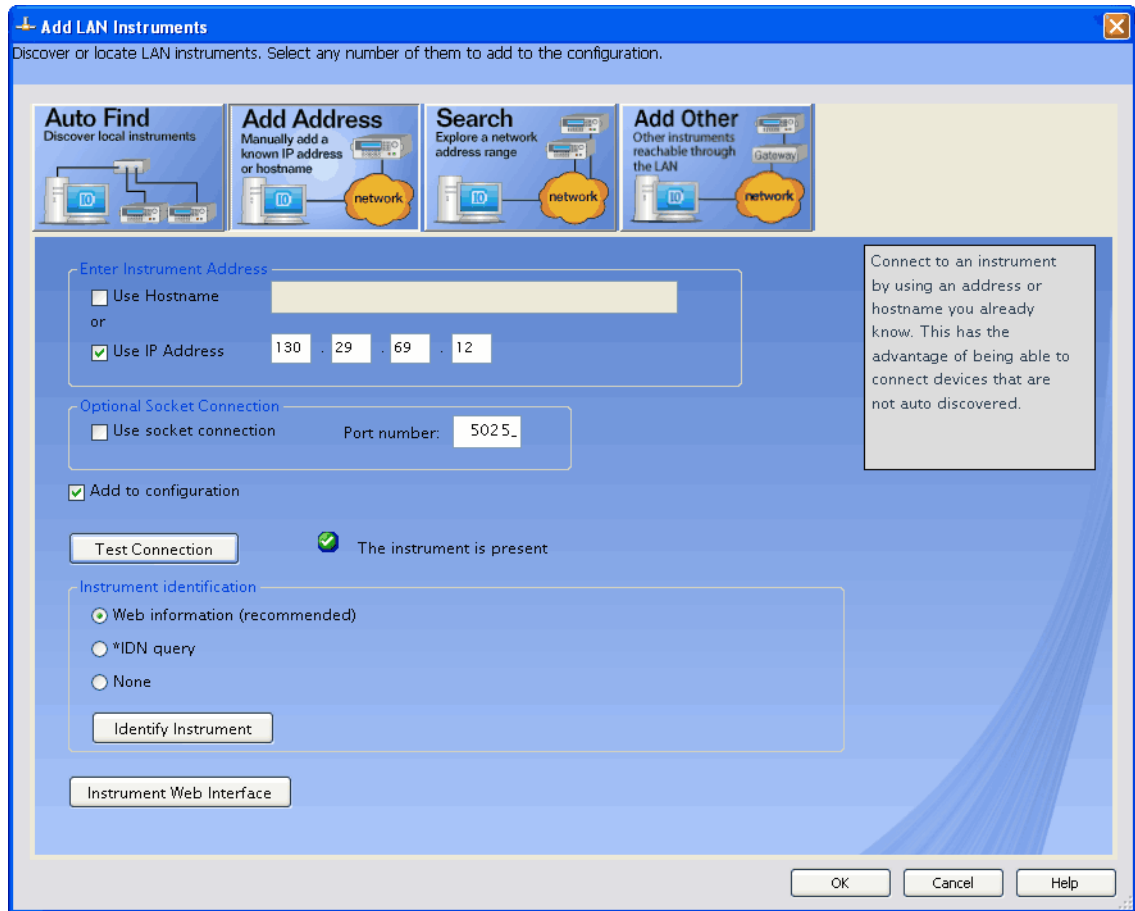

- iii If the instrument is successfully opened, click **OK** to close the dialog. If the instrument is not opened successfully, go back and verify the LAN connections and the oscilloscope setup.

- 3 Test some commands on the instrument:
 - a Right-click on the instrument and choose **Send Commands To This Instrument** from the popup menu.

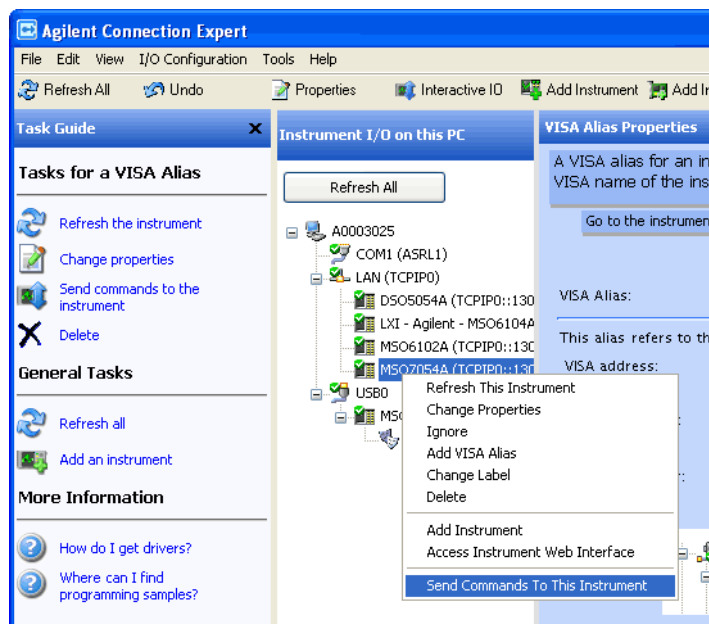

- b In the Agilent Interactive IO application, enter commands in the **Command** field and press **Send Command**, **Read Response**, or **Send&Read**.

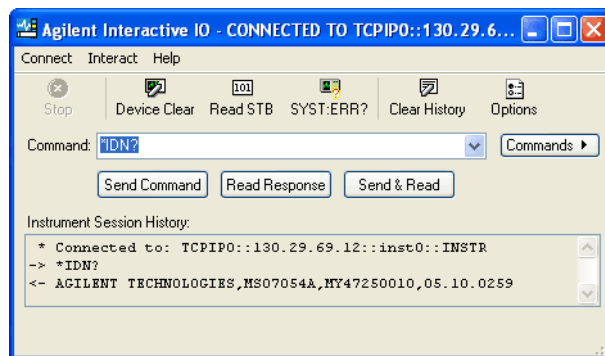

- c Choose **Connect>Exit** from the menu to exit the Agilent Interactive IO application.
- 4 In the Agilent Connection Expert application, choose **File>Exit** from the menu to exit the application.

2 Setting Up

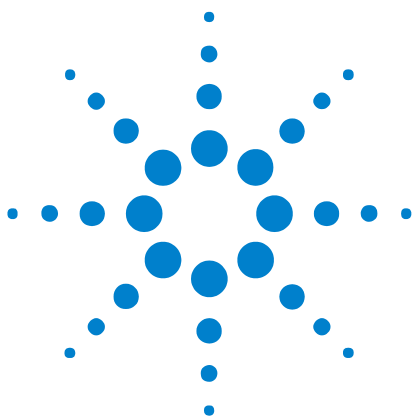

3 Getting Started

Basic Oscilloscope Program Structure	40
Programming the Oscilloscope	42
Other Ways of Sending Commands	51

This chapter gives you an overview of programming the 7000 Series oscilloscopes. It describes basic oscilloscope program structure and shows how to program the oscilloscope using a few simple examples.

The getting started examples show how to send oscilloscope setup, data capture, and query commands, and they show how to read query results.

NOTE

Language for Program Examples

The programming examples in this guide are written in Visual Basic using the Agilent VISA COM library.



Basic Oscilloscope Program Structure

The following figure shows the basic structure of every program you will write for the oscilloscope.

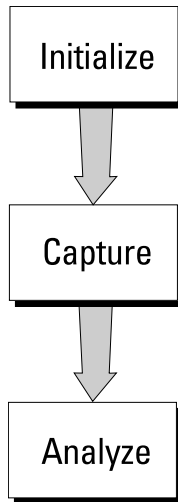

Initializing

To ensure consistent, repeatable performance, you need to start the program, controller, and oscilloscope in a known state. Without correct initialization, your program may run correctly in one instance and not in another. This might be due to changes made in configuration by previous program runs or from the front panel of the oscilloscope.

- Program initialization defines and initializes variables, allocates memory, or tests system configuration.
- Controller initialization ensures that the interface to the oscilloscope is properly set up and ready for data transfer.
- Oscilloscope initialization sets the channel configuration, channel labels, threshold voltages, trigger specification, trigger mode, timebase, and acquisition type.

Capturing Data

Once you initialize the oscilloscope, you can begin capturing data for analysis. Remember that while the oscilloscope is responding to commands from the controller, it is not performing acquisitions. Also, when you change the oscilloscope configuration, any data already captured will most likely be rendered.

To collect data, you use the `:DIGitize` command. This command clears the waveform buffers and starts the acquisition process. Acquisition continues until acquisition memory is full, then stops. The acquired data is displayed by the oscilloscope, and the captured data can be measured, stored in trace memory in the oscilloscope, or transferred to the controller for further analysis. Any additional commands sent while `:DIGitize` is working are buffered until `:DIGitize` is complete.

You could also put the oscilloscope into run mode, then use a wait loop in your program to ensure that the oscilloscope has completed at least one acquisition before you make a measurement. Agilent does not recommend this because the needed length of the wait loop may vary, causing your program to fail. `:DIGitize`, on the other hand, ensures that data capture is complete. Also, `:DIGitize`, when complete, stops the acquisition process so that all measurements are on displayed data, not on a constantly changing data set.

Analyzing Captured Data

After the oscilloscope has completed an acquisition, you can find out more about the data, either by using the oscilloscope measurements or by transferring the data to the controller for manipulation by your program. Built-in measurements include: frequency, duty cycle, period, positive pulse width, and negative pulse width.

Using the `:WAVEform` commands, you can transfer the data to your controller. You may want to display the data, compare it to a known good measurement, or simply check logic patterns at various time intervals in the acquisition.

Programming the Oscilloscope

- "Referencing the IO Library" on page 42
- "Opening the Oscilloscope Connection via the IO Library" on page 43
- "Using :AUToscale to Automate Oscilloscope Setup" on page 44
- "Using Other Oscilloscope Setup Commands" on page 44
- "Capturing Data with the :DIGitize Command" on page 45
- "Reading Query Responses from the Oscilloscope" on page 47
- "Reading Query Results into String Variables" on page 48
- "Reading Query Results into Numeric Variables" on page 48
- "Reading Definite-Length Block Query Response Data" on page 48
- "Sending Multiple Queries and Reading Results" on page 49
- "Checking Instrument Status" on page 50

Referencing the IO Library

No matter which instrument programming library you use (SICL, VISA, or VISA COM), you must reference the library from your program.

In C/C++, you must tell the compiler where to find the include and library files (see the Agilent IO Libraries Suite documentation for more information).

To reference the Agilent VISA COM library in Visual Basic for Applications (VBA, which comes with Microsoft Office products like Excel):

- 1 Choose **Tools>References...** from the main menu.
- 2 In the References dialog, check the "VISA COM 3.0 Type Library".

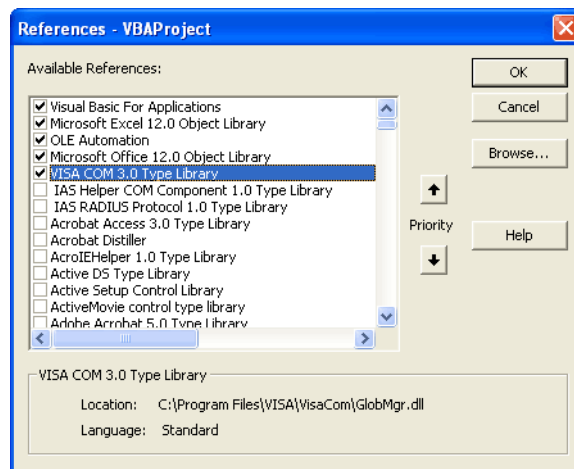

3 Click **OK**.

To reference the Agilent VISA COM library in Microsoft Visual Basic 6.0:

1 Choose **Project>References...** from the main menu.

2 In the References dialog, check the "VISA COM 3.0 Type Library".

3 Click **OK**.

Opening the Oscilloscope Connection via the IO Library

PC controllers communicate with the oscilloscope by sending and receiving messages over a remote interface. Once you have opened a connection to the oscilloscope over the remote interface, programming instructions normally appear as ASCII character strings embedded inside write statements of the programming language. Read statements are used to read query responses from the oscilloscope.

For example, when using the Agilent VISA COM library in Visual Basic (after opening the connection to the instrument using the ResourceManager object's Open method), the FormattedIO488 object's WriteString, WriteNumber, WriteList, or WriteIEEEBlock methods are used for sending commands and queries. After a query is sent, the response is read using the ReadString, ReadNumber, ReadList, or ReadIEEEBlock methods.

The following Visual Basic statements open the connection and send a command that turns on the oscilloscope's label display.

```
Dim myMgr As VisaComLib.ResourceManager
Dim myScope As VisaComLib.FormattedIO488

Set myMgr = New VisaComLib.ResourceManager
Set myScope = New VisaComLib.FormattedIO488
```

```
' Open the connection to the oscilloscope. Get the VISA Address from the
' Agilent Connection Expert (installed with Agilent IO Libraries Suite).
Set myScope.IO = myMgr.Open("<VISA Address>")
```

```
' Send a command.
myScope.WriteString ":DISPlay:LABel ON"
```

The ":DISPLAY:LABEL ON" in the above example is called a *program message*. Program messages are explained in more detail in "[Program Message Syntax](#)" on page 741.

Initializing the Interface and the Oscilloscope

To make sure the bus and all appropriate interfaces are in a known state, begin every program with an initialization statement. When using the Agilent VISA COM library, you can use the resource session object's Clear method to clear the interface buffer:

```
Dim myMgr As VisaComLib.ResourceManager
Dim myScope As VisaComLib.FormattedIO488

Set myMgr = New VisaComLib.ResourceManager
Set myScope = New VisaComLib.FormattedIO488

' Open the connection to the oscilloscope. Get the VISA Address from the
' Agilent Connection Expert (installed with Agilent IO Libraries Suite).
Set myScope.IO = myMgr.Open("<VISA Address>")

' Clear the interface buffer.
myScope.IO.Clear
```

When you are using GPIB, CLEAR also resets the oscilloscope's parser. The parser is the program which reads in the instructions which you send it.

After clearing the interface, initialize the instrument to a preset state:

```
myScope.WriteString "*RST"
```

NOTE

Information for Initializing the Instrument

The actual commands and syntax for initializing the instrument are discussed in "[Common \(*\) Commands](#)" on page 105.

Refer to the Agilent IO Libraries Suite documentation for information on initializing the interface.

Using :AUToscale to Automate Oscilloscope Setup

The :AUToscale command performs a very useful function for unknown waveforms by setting up the vertical channel, time base, and trigger level of the instrument.

The syntax for the autoscale command is:

```
myScope.WriteString ":AUToscale"
```

Using Other Oscilloscope Setup Commands

A typical oscilloscope setup would set the vertical range and offset voltage, the horizontal range, delay time, delay reference, trigger mode, trigger level, and slope. An example of the commands that might be sent to the oscilloscope are:

```
myScope.WriteString ":CHANnel1:PROBe 10"
myScope.WriteString ":CHANnel1:RANGe 16"
myScope.WriteString ":CHANnel1:OFFSet 1.00"
myScope.WriteString ":TIMEbase:MODE MAIN"
myScope.WriteString ":TIMEbase:RANGe 1E-3"
myScope.WriteString ":TIMEbase:DELay 100E-6"
```

Vertical is set to 16 V full-scale (2 V/div) with center of screen at 1 V and probe attenuation set to 10. This example sets the time base at 1 ms full-scale (100 ms/div) with a delay of 100 μ s.

Example Oscilloscope Setup Code

This program demonstrates the basic command structure used to program the oscilloscope.

```
' Initialize the instrument interface to a known state.
myScope.IO.Clear

' Initialize the instrument to a preset state.
myScope.WriteString "*RST"

' Set the time base mode to normal with the horizontal time at
' 50 ms/div with 0 s of delay referenced at the center of the
' graticule.
myScope.WriteString ":TIMEbase:RANGe 5E-4" ' Time base to 50 us/div.
myScope.WriteString ":TIMEbase:DELay 0" ' Delay to zero.
myScope.WriteString ":TIMEbase:REFerence CENTER" ' Display ref. at
' center.

' Set the vertical range to 1.6 volts full scale with center screen
' at -0.4 volts with 10:1 probe attenuation and DC coupling.
myScope.WriteString ":CHANnel:PROBE 10" ' Probe attenuation
' to 10:1.
myScope.WriteString ":CHANnel:RANGe 1.6" ' Vertical range
' 1.6 V full scale.
myScope.WriteString ":CHANnel:OFFSet -.4" ' Offset to -0.4.
myScope.WriteString ":CHANnel:COUPLing DC" ' Coupling to DC.

' Configure the instrument to trigger at -0.4 volts with normal
' triggering.
myScope.WriteString ":TRIGger:SWEep NORMal" ' Normal triggering.
myScope.WriteString ":TRIGger:LEVel -.4" ' Trigger level to -0.4.
myScope.WriteString ":TRIGger:SLOPe POSitive" ' Trigger on pos. slope.

' Configure the instrument for normal acquisition.
myScope.WriteString ":ACQuire:TYPE NORMal" ' Normal acquisition.
```

Capturing Data with the :DIGitize Command

The :DIGitize command captures data that meets the specifications set up by the :ACquire subsystem. When the digitize process is complete, the acquisition is stopped. The captured data can then be measured by the instrument or transferred to the controller for further analysis. The captured data consists of two parts: the waveform data record, and the preamble.

NOTE**Ensure New Data is Collected**

When you change the oscilloscope configuration, the waveform buffers are cleared. Before doing a measurement, send the :DIGitize command to the oscilloscope to ensure new data has been collected.

When you send the :DIGitize command to the oscilloscope, the specified channel signal is digitized with the current :ACQUIRE parameters. To obtain waveform data, you must specify the :WAVEFORM parameters for the SOURCE channel, the FORMAT type, and the number of POINTs prior to sending the :WAVEFORM:DATA? query.

NOTE**Set :TIMEbase:MODE to MAIN when using :DIGitize**

:TIMEbase:MODE must be set to MAIN to perform a :DIGitize command or to perform any :WAVEFORM subsystem query. A "Settings conflict" error message will be returned if these commands are executed when MODE is set to ROLL, XY, or WINDOW (zoomed). Sending the *RST (reset) command will also set the time base mode to normal.

The number of data points comprising a waveform varies according to the number requested in the :ACQUIRE subsystem. The :ACQUIRE subsystem determines the number of data points, type of acquisition, and number of averages used by the :DIGitize command. This allows you to specify exactly what the digitized information contains.

The following program example shows a typical setup:

```
myScope.WriteString ":ACQUIRE:TYPE AVERage"  
myScope.WriteString ":ACQUIRE:COMPLETE 100"  
myScope.WriteString ":ACQUIRE:COUNT 8"  
myScope.WriteString ":DIGitize CHANNEL1"  
myScope.WriteString ":WAVEFORM:SOURCE CHANNEL1"  
myScope.WriteString ":WAVEFORM:FORMAT BYTE"  
myScope.WriteString ":WAVEFORM:POINTS 500"  
myScope.WriteString ":WAVEFORM:DATA?"
```

This setup places the instrument into the averaged mode with eight averages. This means that when the :DIGitize command is received, the command will execute until the signal has been averaged at least eight times.

After receiving the :WAVEFORM:DATA? query, the instrument will start passing the waveform information.

Digitized waveforms are passed from the instrument to the controller by sending a numerical representation of each digitized point. The format of the numerical representation is controlled with the :WAVEFORM:FORMAT command and may be selected as BYTE, WORD, or ASCII.

The easiest method of transferring a digitized waveform depends on data structures, formatting available and I/O capabilities. You must scale the integers to determine the voltage value of each point. These integers are passed starting with the left most point on the instrument's display.

For more information, see the waveform subsystem commands and corresponding program code examples in "[:WAVEform Commands](#)" on page 573.

NOTE**Aborting a Digitize Operation Over the Programming Interface**

When using the programming interface, you can abort a digitize operation by sending a Device Clear over the bus (for example, `myScope.IO.Clear`).

Reading Query Responses from the Oscilloscope

After receiving a query (command header followed by a question mark), the instrument interrogates the requested function and places the answer in its output queue. The answer remains in the output queue until it is read or another command is issued. When read, the answer is transmitted across the interface to the designated listener (typically a controller).

The statement for reading a query response message from an instrument's output queue typically has a format specification for handling the response message.

When using the VISA COM library in Visual Basic, you use different read methods (`ReadString`, `ReadNumber`, `ReadList`, or `ReadIEEEBlock`) for the various query response formats. For example, to read the result of the query command `:CHANnel1:COUPLing?` you would execute the statements:

```
myScope.WriteString ":CHANnel1:COUPLing?"
Dim strQueryResult As String
strQueryResult = myScope.ReadString
```

This reads the current setting for the channel one coupling into the string variable `strQueryResult`.

All results for queries (sent in one program message) must be read before another program message is sent.

Sending another command before reading the result of the query clears the output buffer and the current response. This also causes an error to be placed in the error queue.

Executing a read statement before sending a query causes the controller to wait indefinitely.

The format specification for handling response messages depends on the programming language.

Reading Query Results into String Variables

The output of the instrument may be numeric or character data depending on what is queried. Refer to the specific command descriptions in ["Commands by Subsystem"](#) on page 103 for the formats and types of data returned from queries.

NOTE

Express String Variables Using Exact Syntax

In Visual Basic, string variables are case sensitive and must be expressed exactly the same each time they are used.

The following example shows numeric data being returned to a string variable:

```
myScope.WriteString ":CHANnel1:RANGe?"
Dim strQueryResult As String
strQueryResult = myScope.ReadString
MsgBox "Range (string):" + strQueryResult
```

After running this program, the controller displays:

Range (string): +40.0E+00

Reading Query Results into Numeric Variables

The following example shows numeric data being returned to a numeric variable:

```
myScope.WriteString ":CHANnel1:RANGe?"
Dim varQueryResult As Variant
strQueryResult = myScope.ReadNumber
MsgBox "Range (variant):" + CStr(varQueryResult)
```

After running this program, the controller displays:

Range (variant): 40

Reading Definite-Length Block Query Response Data

Definite-length block query response data allows any type of device-dependent data to be transmitted over the system interface as a series of 8-bit binary data bytes. This is particularly useful for sending large quantities of data or 8-bit extended ASCII codes. The syntax is a pound sign (#) followed by a non-zero digit representing the number of digits in the decimal integer. After the non-zero digit is the decimal integer that states the number of 8-bit data bytes being sent. This is followed by the actual data.

For example, for transmitting 1000 bytes of data, the syntax would be:

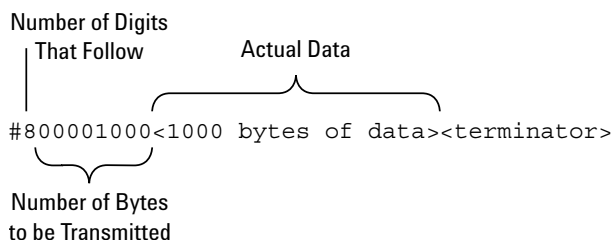

Figure 2 Definite-length block response data

The "8" states the number of digits that follow, and "00001000" states the number of bytes to be transmitted.

The VISA COM library's ReadIEEEBlock and WriteIEEEBlock methods understand the definite-length block syntax, so you can simply use variables that contain the data:

```
' Read oscilloscope setup using ":SYSTEM:SETup?" query.
myScope.WriteString ":SYSTEM:SETup?"
Dim varQueryResult As Variant
varQueryResult = myScope.ReadIEEEBlock(BinaryType_UI1)

' Write learn string back to oscilloscope using ":SYSTEM:SETup" command:
myScope.WriteIEEEBlock ":SYSTEM:SETup ", varQueryResult
```

Sending Multiple Queries and Reading Results

You can send multiple queries to the instrument within a single command string, but you must also read them back as a single query result. This can be accomplished by reading them back into a single string variable, multiple string variables, or multiple numeric variables.

For example, to read the :TIMEbase:RANGE?;DElay? query result into a single string variable, you could use the commands:

```
myScope.WriteString ":TIMEbase:RANGE?;DElay?"
Dim strQueryResult As String
strQueryResult = myScope.ReadString
MsgBox "Timebase range; delay:" + strQueryResult
```

When you read the result of multiple queries into a single string variable, each response is separated by a semicolon. For example, the output of the previous example would be:

```
Timebase range; delay: <range_value>;<delay_value>
```

To read the :TIMEbase:RANGE?;DElay? query result into multiple string variables, you could use the ReadList method to read the query results into a string array variable using the commands:

```
myScope.WriteString ":TIMEbase:RANGE?;DElay?"
Dim strResults() As String
```

```
strResults() = myScope.ReadList(ASCIIType_BSTR)
MsgBox "Timebase range: " + strResults(0) + ", delay: " + strResults(1)
```

To read the `:TIMEbase:RANGE?;DElay?` query result into multiple numeric variables, you could use the `ReadList` method to read the query results into a variant array variable using the commands:

```
myScope.WriteString ":TIMEbase:RANGE?;DElay?"
Dim varResults() As Variant
varResults() = myScope.ReadList
MsgBox "Timebase range: " + FormatNumber(varResults(0) * 1000, 4) + _
      " ms, delay: " + FormatNumber(varResults(1) * 1000000, 4) + " us"
```

Checking Instrument Status

Status registers track the current status of the instrument. By checking the instrument status, you can find out whether an operation has been completed, whether the instrument is receiving triggers, and more.

For more information, see ["Status Reporting"](#) on page 705 which explains how to check the status of the instrument.

Other Ways of Sending Commands

Standard Commands for Programmable Instrumentation (SCPI) can be sent via a Telnet socket or through the Browser Web Control.

Telnet Sockets

The following information is provided for programmers who wish to control the oscilloscope with SCPI commands in a Telnet session.

To connect to the oscilloscope via a telnet socket, issue the following command:

```
telnet <hostname> 5024
```

where <hostname> is the hostname of the oscilloscope. This will give you a command line with prompt.

For a command line without a prompt, use port 5025. For example:

```
telnet <hostname> 5025
```

Sending SCPI Commands Using Browser Web Control

To send SCPI commands using the Browser Web Control feature, establish a connection to the oscilloscope via LAN as described in the *7000 Series Oscilloscopes User's Guide*. When you make the connection to the oscilloscope via LAN and the instrument's welcome page is displayed, select the **Browser Web Control** tab, then select the **Remote Programming** link.

3 Getting Started



4 Commands Quick Reference

Command Summary 54

Syntax Elements 99



Command Summary

Table 2 Common (*) Commands Summary

Command	Query	Options and Query Returns																																				
*CLS (see page 109)	n/a	n/a																																				
*ESE <mask> (see page 110)	*ESE? (see page 111)	<p><mask> ::= 0 to 255; an integer in NR1 format:</p> <table border="1"> <thead> <tr> <th>Bit</th> <th>Weight</th> <th>Name</th> <th>Enables</th> </tr> </thead> <tbody> <tr> <td>7</td> <td>128</td> <td>PON</td> <td>Power On</td> </tr> <tr> <td>6</td> <td>64</td> <td>URQ</td> <td>User Request</td> </tr> <tr> <td>5</td> <td>32</td> <td>CME</td> <td>Command Error</td> </tr> <tr> <td>4</td> <td>16</td> <td>EXE</td> <td>Execution Error</td> </tr> <tr> <td>3</td> <td>8</td> <td>DDE</td> <td>Dev. Dependent Error</td> </tr> <tr> <td>2</td> <td>4</td> <td>QYE</td> <td>Query Error</td> </tr> <tr> <td>1</td> <td>2</td> <td>RQL</td> <td>Request Control</td> </tr> <tr> <td>0</td> <td>1</td> <td>OPC</td> <td>Operation Complete</td> </tr> </tbody> </table>	Bit	Weight	Name	Enables	7	128	PON	Power On	6	64	URQ	User Request	5	32	CME	Command Error	4	16	EXE	Execution Error	3	8	DDE	Dev. Dependent Error	2	4	QYE	Query Error	1	2	RQL	Request Control	0	1	OPC	Operation Complete
Bit	Weight	Name	Enables																																			
7	128	PON	Power On																																			
6	64	URQ	User Request																																			
5	32	CME	Command Error																																			
4	16	EXE	Execution Error																																			
3	8	DDE	Dev. Dependent Error																																			
2	4	QYE	Query Error																																			
1	2	RQL	Request Control																																			
0	1	OPC	Operation Complete																																			
n/a	*ESR? (see page 112)	<status> ::= 0 to 255; an integer in NR1 format																																				
n/a	*IDN? (see page 112)	AGILENT TECHNOLOGIES,<model>,<serial number>,X.XX.XX <model> ::= the model number of the instrument <serial number> ::= the serial number of the instrument <X.XX.XX> ::= the software revision of the instrument																																				
n/a	*LRN? (see page 115)	<learn_string> ::= current instrument setup as a block of data in IEEE 488.2 # format																																				
*OPC (see page 116)	*OPC? (see page 116)	ASCII "1" is placed in the output queue when all pending device operations have completed.																																				

Table 2 Common (*) Commands Summary (continued)

Command	Query	Options and Query Returns
n/a	*OPT? (see page 117)	<pre><return_value> ::= 0,0,<license info> <license info> ::= <All field>, <reserved>, <Factory MSO>, <Upgraded MSO>, <Xilinx FPGA Probe>, <Memory>, <Low Speed Serial>, <Automotive Serial>, <reserved>, <Secure>, <Battery>, <Altera FPGA Probe>, <FlexRay Serial>, <reserved>, <RS-232/UART Serial>, <reserved> <All field> ::= {0 All} <reserved> ::= 0 <Factory MSO> ::= {0 MSO} <Upgraded MSO> ::= {0 MSO} <Xilinx FPGA Probe> ::= {0 FPG} <Memory> ::= {0 mem2M mem8M} <Low Speed Serial> ::= {0 LSS} <Automotive Serial> ::= {0 AMS} <Secure> ::= {0 SEC} <Battery> ::= {0 BAT} <Altera FPGA Probe> ::= {0 ALT} <FlexRay Serial> ::= {0 FRS} <RS-232/UART Serial> ::= {0 232}</pre>
*RCL <value> (see page 119)	n/a	<value> ::= {0 1 2 3 4 5 6 7 8 9}
*RST (see page 120)	n/a	See *RST (Reset) (see page 120)
*SAV <value> (see page 123)	n/a	<value> ::= {0 1 2 3 4 5 6 7 8 9}
*SRE <mask> (see page 124)	*SRE? (see page 125)	<pre><mask> ::= sum of all bits that are set, 0 to 255; an integer in NR1 format. <mask> ::= following values: Bit Weight Name Enables ----- 7 128 OPER Operation Status Reg 6 64 ---- (Not used.) 5 32 ESB Event Status Bit 4 16 MAV Message Available 3 8 ---- (Not used.) 2 4 MSG Message 1 2 USR User 0 1 TRG Trigger</pre>

4 Commands Quick Reference

Table 2 Common (*) Commands Summary (continued)

Command	Query	Options and Query Returns
n/a	*STB? (see page 126)	<p><value> ::= 0 to 255; an integer in NR1 format, as shown in the following:</p> <p>Bit Weight Name "1" Indicates</p> <pre> ----- 7 128 OPER Operation status condition occurred. 6 64 RQS/ Instrument is MSS requesting service. 5 32 ESB Enabled event status condition occurred. 4 16 MAV Message available. 3 8 ---- (Not used.) 2 4 MSG Message displayed. 1 2 USR User event condition occurred. 0 1 TRG A trigger occurred. </pre>
*TRG (see page 128)	n/a	n/a
n/a	*TST? (see page 129)	<result> ::= 0 or non-zero value; an integer in NR1 format
*WAI (see page 130)	n/a	n/a

Table 3 Root (:) Commands Summary

Command	Query	Options and Query Returns
:ACTivity (see page 134)	:ACTivity? (see page 134)	<p><return value> ::= <edges>,<levels></p> <p><edges> ::= presence of edges (32-bit integer in NR1 format)</p> <p><levels> ::= logical highs or lows (32-bit integer in NR1 format)</p>
n/a	:AER? (see page 135)	{0 1}; an integer in NR1 format
:AUToscale [<source>[, ..., <source>]] (see page 136)	n/a	<p><source> ::= CHANnel<n> for DSO models</p> <p><source> ::= {CHANnel<n> DIGital0, ..., DIGital15 POD1 POD2} for MSO models</p> <p><source> can be repeated up to 5 times</p> <p><n> ::= 1-2 or 1-4 in NR1 format</p>

Table 3 Root (:) Commands Summary (continued)

Command	Query	Options and Query Returns
:AUToscale:AMODE <value> (see page 138)	:AUToscale:AMODE? (see page 138)	<value> ::= {NORMAL CURRENT}}
:AUToscale:CHANnels <value> (see page 139)	:AUToscale:CHANnels? (see page 139)	<value> ::= {ALL DISPLAYed}}
:BLANK [<source>] (see page 140)	n/a	<source> ::= {CHANnel<n> FUNCTION MATH SBUS} for DSO models <source> ::= {CHANnel<n> DIGital0,...,DIGital15 POD{1 2} BUS{1 2} FUNCTION MATH SBUS} for MSO models <n> ::= 1-2 or 1-4 in NR1 format
:CDISplay (see page 141)	n/a	n/a
:DIGitize [<source>[,...,<source>]] (see page 142)	n/a	<source> ::= {CHANnel<n> FUNCTION MATH SBUS} for DSO models <source> ::= {CHANnel<n> DIGital0,...,DIGital15 POD{1 2} BUS{1 2} FUNCTION MATH SBUS} for MSO models <source> can be repeated up to 5 times <n> ::= 1-2 or 1-4 in NR1 format
:HWEenable <n> (see page 144)	:HWEenable? (see page 144)	<n> ::= 16-bit integer in NR1 format
n/a	:HWERegister:CONDition? (see page 146)	<n> ::= 16-bit integer in NR1 format
n/a	:HWERegister[:EVENT]? (see page 148)	<n> ::= 16-bit integer in NR1 format
:MERGe <pixel memory> (see page 150)	n/a	<pixel memory> ::= {PMEMory{0 1 2 3 4 5 6 7 8 9}}
:MTEenable <n> (see page 151)	:MTEenable? (see page 151)	<n> ::= 16-bit integer in NR1 format
n/a	:MTERegister[:EVENT]? (see page 153)	<n> ::= 16-bit integer in NR1 format
:OPEE <n> (see page 155)	:OPEE? (see page 156)	<n> ::= 16-bit integer in NR1 format

Table 3 Root (:) Commands Summary (continued)

Command	Query	Options and Query Returns
n/a	:OPERregister:CONDition? (see page 157)	<n> ::= 16-bit integer in NR1 format
n/a	:OPERRegister[:EVENT]? (see page 159)	<n> ::= 16-bit integer in NR1 format
:OVLenable <mask> (see page 161)	:OVLenable? (see page 162)	<mask> ::= 16-bit integer in NR1 format as shown: Bit Weight Input ----- 10 1024 Ext Trigger Fault 9 512 Channel 4 Fault 8 256 Channel 3 Fault 7 128 Channel 2 Fault 6 64 Channel 1 Fault 4 16 Ext Trigger OVL 3 8 Channel 4 OVL 2 4 Channel 3 OVL 1 2 Channel 2 OVL 0 1 Channel 1 OVL
n/a	:OVLRegister? (see page 163)	<value> ::= integer in NR1 format. See OVLenable for <value>
:PRINT [<options>] (see page 165)	n/a	<options> ::= [<print option>][,...,<print option>] <print option> ::= {COLor GRAYscale PRINter0 BMP8bit BMP PNG NOFactoRs FACToRs} <print option> can be repeated up to 5 times.
:RUN (see page 166)	n/a	n/a
n/a	:SERial (see page 167)	<return value> ::= unquoted string containing serial number
:SINGle (see page 168)	n/a	n/a
n/a	:STATus? <display> (see page 169)	{0 1} <display> ::= {CHANnel<n> DIGital0,...,DIGital15 POD{1 2} BUS{1 2} FUNCTION MATH SBUS} <n> ::= 1-2 or 1-4 in NR1 format
:STOP (see page 170)	n/a	n/a

Table 3 Root (:) Commands Summary (continued)

Command	Query	Options and Query Returns
n/a	:TER? (see page 171)	{0 1}
:VIEW <source> (see page 172)	n/a	<source> ::= {CHANnel<n> PMEMory{0 1 2 3 4 5 6 7 8 9} FUNction MATH SBUS} for DSO models <source> ::= {CHANnel<n> DIGital0,...,DIGital15 PMEMory{0 1 2 3 4 5 6 7 8 9} POD{1 2} BUS{1 2} FUNction MATH SBUS} for MSO models <n> ::= 1-2 or 1-4 in NR1 format

Table 4 :ACQUIRE Commands Summary

Command	Query	Options and Query Returns
n/a	:ACQUIRE:AAlias? (see page 175)	{1 0}
:ACQUIRE:COMPLETE <complete> (see page 176)	:ACQUIRE:COMPLETE? (see page 176)	<complete> ::= 100; an integer in NR1 format
:ACQUIRE:COUNT <count> (see page 177)	:ACQUIRE:COUNT? (see page 177)	<count> ::= an integer from 2 to 65536 in NR1 format
:ACQUIRE:DAALIAS <mode> (see page 178)	:ACQUIRE:DAALIAS? (see page 178)	<mode> ::= {DISable AUTO}
:ACQUIRE:MODE <mode> (see page 179)	:ACQUIRE:MODE? (see page 179)	<mode> ::= {RTIME ETIME SEGmented}
n/a	:ACQUIRE:POINTS? (see page 180)	<# points> ::= an integer in NR1 format
:ACQUIRE:RSIGNAL <ref_signal_mode> (see page 181)	:ACQUIRE:RSIGNAL? (see page 181)	<ref_signal_mode> ::= {OFF OUT IN}
:ACQUIRE:SEGmented:ANALyze (see page 182)	n/a	n/a (with Option SGM)
:ACQUIRE:SEGmented:COUNT <count> (see page 183)	:ACQUIRE:SEGmented:COUNT? (see page 183)	<count> ::= an integer from 2 to 2000 in NR1 format (with Option SGM)

4 Commands Quick Reference

Table 4 :ACQUIRE Commands Summary (continued)

Command	Query	Options and Query Returns
:ACQUIRE:SEGMENTED:IN Dex <index> (see page 184)	:ACQUIRE:SEGMENTED:IN Dex? (see page 184)	<index> ::= an integer from 2 to 2000 in NR1 format (with Option SGM)
n/a	:ACQUIRE:SRATE? (see page 187)	<sample_rate> ::= sample rate (samples/s) in NR3 format
:ACQUIRE:TYPE <type> (see page 188)	:ACQUIRE:TYPE? (see page 188)	<type> ::= {NORMAL AVERAGE HRESOLUTION PEAK}

Table 5 :BUS<n> Commands Summary

Command	Query	Options and Query Returns
:BUS<n>:BIT<m> {{0 OFF} {1 ON}} (see page 192)	:BUS<n>:BIT<m>? (see page 192)	{0 1} <n> ::= 1 or 2; an integer in NR1 format <m> ::= 0-15; an integer in NR1 format
:BUS<n>:BITS <channel_list>, {{0 OFF} {1 ON}} (see page 193)	:BUS<n>:BITS? (see page 193)	<channel_list>, {0 1} <channel_list> ::= (@<m>, <m>:<m> ...) where ", " is separator and ":" is range <n> ::= 1 or 2; an integer in NR1 format <m> ::= 0-15; an integer in NR1 format
:BUS<n>:CLEAR (see page 195)	n/a	<n> ::= 1 or 2; an integer in NR1 format
:BUS<n>:DISPLAY {{0 OFF} {1 ON}} (see page 196)	:BUS<n>:DISPLAY? (see page 196)	{0 1} <n> ::= 1 or 2; an integer in NR1 format

Table 5 :BUS<n> Commands Summary (continued)

Command	Query	Options and Query Returns
:BUS<n>:LAbel <string> (see page 197)	:BUS<n>:LAbel? (see page 197)	<string> ::= quoted ASCII string up to 10 characters <n> ::= 1 or 2; an integer in NR1 format
:BUS<n>:MASk <mask> (see page 198)	:BUS<n>:MASk? (see page 198)	<mask> ::= 32-bit integer in decimal, <nondecimal>, or <string> <nondecimal> ::= #Hnn...n where n ::= {0,...,9 A,...,F} for hexadecimal <nondecimal> ::= #Bnn...n where n ::= {0 1} for binary <string> ::= "0xnn...n" where n ::= {0,...,9 A,...,F} for hexadecimal <n> ::= 1 or 2; an integer in NR1 format

Table 6 :CALibrate Commands Summary

Command	Query	Options and Query Returns
n/a	:CALibrate:DATE? (see page 201)	<return value> ::= <day>,<month>,<year>; all in NR1 format
:CALibrate:LAbel <string> (see page 202)	:CALibrate:LAbel? (see page 202)	<string> ::= quoted ASCII string up to 32 characters
:CALibrate:OUTPut <signal> (see page 203)	:CALibrate:OUTPut? (see page 203)	<signal> ::= {TRIGgers SOURce DSOURce MASk}
:CALibrate:STARt (see page 204)	n/a	n/a
n/a	:CALibrate:STATus? (see page 205)	<return value> ::= ALL,<status_code>,<status_string > <status_code> ::= an integer status code <status_string> ::= an ASCII status string
n/a	:CALibrate:SWITCh? (see page 206)	{PROtected UNPRotected}

4 Commands Quick Reference

Table 6 :CALibrate Commands Summary (continued)

Command	Query	Options and Query Returns
n/a	:CALibrate:TEMPerature? (see page 207)	<return value> ::= degrees C delta since last cal in NR3 format
n/a	:CALibrate:TIME? (see page 208)	<return value> ::= <hours>,<minutes>,<seconds>; all in NR1 format

Table 7 :CHANnel<n> Commands Summary

Command	Query	Options and Query Returns
:CHANnel<n>:BWLimit {0 OFF} {1 ON}} (see page 212)	:CHANnel<n>:BWLimit? (see page 212)	{0 1} <n> ::= 1-2 or 1-4 in NR1 format
:CHANnel<n>:COUpling <coupling> (see page 213)	:CHANnel<n>:COUpling? (see page 213)	<coupling> ::= {AC DC} <n> ::= 1-2 or 1-4 in NR1 format
:CHANnel<n>:DISPlay {0 OFF} {1 ON}} (see page 214)	:CHANnel<n>:DISPlay? (see page 214)	{0 1} <n> ::= 1-2 or 1-4 in NR1 format
:CHANnel<n>:IMPedance <impedance> (see page 215)	:CHANnel<n>:IMPedance? (see page 215)	<impedance> ::= {ONEMeg FIFTy} <n> ::= 1-2 or 1-4 in NR1 format
:CHANnel<n>:INVert {0 OFF} {1 ON}} (see page 216)	:CHANnel<n>:INVert? (see page 216)	{0 1} <n> ::= 1-2 or 1-4 in NR1 format
:CHANnel<n>:LABel <string> (see page 217)	:CHANnel<n>:LABel? (see page 217)	<string> ::= any series of 10 or less ASCII characters enclosed in quotation marks <n> ::= 1-2 or 1-4 in NR1 format
:CHANnel<n>:OFFSet <offset>[suffix] (see page 218)	:CHANnel<n>:OFFSet? (see page 218)	<offset> ::= Vertical offset value in NR3 format [suffix] ::= {V mV} <n> ::= 1-2 or 1-4; in NR1 format
:CHANnel<n>:PROBe <attenuation> (see page 219)	:CHANnel<n>:PROBe? (see page 219)	<attenuation> ::= Probe attenuation ratio in NR3 format <n> ::= 1-2 or 1-4r in NR1 format
n/a	:CHANnel<n>:PROBe:ID? (see page 220)	<probe id> ::= unquoted ASCII string up to 11 characters <n> ::= 1-2 or 1-4 in NR1 format

Table 7 :CHANnel<n> Commands Summary (continued)

Command	Query	Options and Query Returns
:CHANnel<n>:PROBe:SKEW <skew_value> (see page 221)	:CHANnel<n>:PROBE:SKEW? (see page 221)	<skew_value> ::= -100 ns to +100 ns in NR3 format <n> ::= 1-2 or 1-4 in NR1 format
:CHANnel<n>:PROBe:STYPe <signal type> (see page 222)	:CHANnel<n>:PROBE:STYPe? (see page 222)	<signal type> ::= {DIFFerential SINGLE} <n> ::= 1-2 or 1-4 in NR1 format
:CHANnel<n>:PROTection (see page 223)	:CHANnel<n>:PROTECTioN? (see page 223)	{NORM TRIP} <n> ::= 1-2 or 1-4 in NR1 format
:CHANnel<n>:RANGe <range>[suffix] (see page 224)	:CHANnel<n>:RANGE? (see page 224)	<range> ::= Vertical full-scale range value in NR3 format [suffix] ::= {V mV} <n> ::= 1-2 or 1-4 in NR1 format
:CHANnel<n>:SCALe <scale>[suffix] (see page 225)	:CHANnel<n>:SCALE? (see page 225)	<scale> ::= Vertical units per division value in NR3 format [suffix] ::= {V mV} <n> ::= 1-2 or 1-4 in NR1 format
:CHANnel<n>:UNITs <units> (see page 226)	:CHANnel<n>:UNITs? (see page 226)	<units> ::= {VOLT AMPere} <n> ::= 1-2 or 1-4 in NR1 format
:CHANnel<n>:VERNier {{0 OFF} {1 ON}} (see page 227)	:CHANnel<n>:VERNier? (see page 227)	{0 1} <n> ::= 1-2 or 1-4 in NR1 format

Table 8 :DIGital<n> Commands Summary

Command	Query	Options and Query Returns
:DIGital<n>:DISPlay {{0 OFF} {1 ON}} (see page 230)	:DIGital<n>:DISPlay? (see page 230)	{0 1} <n> ::= 0-15; an integer in NR1 format
:DIGital<n>:LABel <string> (see page 231)	:DIGital<n>:LABel? (see page 231)	<string> ::= any series of 10 or less ASCII characters enclosed in quotation marks <n> ::= 0-15; an integer in NR1 format
:DIGital<n>:POSition <position> (see page 232)	:DIGital<n>:POSition? (see page 232)	<n> ::= 0-15; an integer in NR1 format <position> ::= 0-7 if display size = large, 0-15 if size = medium, 0-31 if size = small

4 Commands Quick Reference

Table 8 :DIGital<n> Commands Summary (continued)

Command	Query	Options and Query Returns
:DIGital<n>:SIZE <value> (see page 233)	:DIGital<n>:SIZE? (see page 233)	<value> ::= {SMALl MEDium LARGE}
:DIGital<n>:THReshold <value>[suffix] (see page 234)	:DIGital<n>:THReshold ? (see page 234)	<n> ::= 0-15; an integer in NR1 format <value> ::= {CMOS ECL TTL <user defined value>} <user defined value> ::= value in NR3 format from -8.00 to +8.00 [suffix] ::= {V mV uV}

Table 9 :DISPlay Commands Summary

Command	Query	Options and Query Returns
:DISPlay:CLear (see page 237)	n/a	n/a
:DISPlay:DATA [<format>][,][<area>] [,][<palette>]<displa y data> (see page 238)	:DISPlay:DATA? [<format>][,][<area>] [,][<palette>] (see page 238)	<format> ::= {TIFF} (command) <area> ::= {GRATicule} (command) <palette> ::= {MONochrome} (command) <format> ::= {TIFF BMP BMP8bit PNG} (query) <area> ::= {GRATicule SCReen} (query) <palette> ::= {MONochrome GRAYscale COLor} (query) <display data> ::= data in IEEE 488.2 # format
:DISPlay:LABel {{0 OFF} {1 ON}} (see page 240)	:DISPlay:LABel? (see page 240)	{0 1}
:DISPlay:LABList <binary block> (see page 241)	:DISPlay:LABList? (see page 241)	<binary block> ::= an ordered list of up to 75 labels, each 10 characters maximum, separated by newline characters
:DISPlay:PERsistence <value> (see page 242)	:DISPlay:PERsistence? (see page 242)	<value> ::= {MINimum INFinite}}

Table 9 :DISPlay Commands Summary (continued)

Command	Query	Options and Query Returns
:DISPlay:SOURce <value> (see page 243)	:DISPlay:SOURce? (see page 243)	<value> ::= {PMEMory{0 1 2 3 4 5 6 7 8 9}}
:DISPlay:VECTors {{1 ON} {0 OFF}} (see page 244)	:DISPlay:VECTors? (see page 244)	{1 0}

Table 10 :EXternal Trigger Commands Summary

Command	Query	Options and Query Returns
:EXternal:BWLimit <bwlimit> (see page 247)	:EXternal:BWLimit? (see page 247)	<bwlimit> ::= {0 OFF}
:EXternal:IMPedance <value> (see page 248)	:EXternal:IMPedance? (see page 248)	<impedance> ::= {ONEMeg FIFTy}
:EXternal:PROBe <attenuation> (see page 249)	:EXternal:PROBe? (see page 249)	<attenuation> ::= probe attenuation ratio in NR3 format
n/a	:EXternal:PROBe:ID? (see page 250)	<probe id> ::= unquoted ASCII string up to 11 characters
:EXternal:PROBe:SType <signal type> (see page 251)	:EXternal:PROBe:SType ? (see page 251)	<signal type> ::= {DIFFerential SINGle}
:EXternal:PROTection[:CLEar] (see page 252)	:EXternal:PROTection? (see page 252)	{NORM TRIP}
:EXternal:RANGe <range>[<suffix>] (see page 253)	:EXternal:RANGe? (see page 253)	<range> ::= vertical full-scale range value in NR3 format <suffix> ::= {V mV}
:EXternal:UNITs <units> (see page 254)	:EXternal:UNITs? (see page 254)	<units> ::= {VOLT AMPere}

Table 11 :FUNCTION Commands Summary

Command	Query	Options and Query Returns
:FUNCTION:CENTer <frequency> (see page 258)	:FUNCTION:CENTer? (see page 258)	<frequency> ::= the current center frequency in NR3 format. The range of legal values is from 0 Hz to 25 GHz.
:FUNCTION:DISPlay {{0 OFF} {1 ON}} (see page 259)	:FUNCTION:DISPlay? (see page 259)	{0 1}
:FUNCTION:GOFT:OPERat ion <operation> (see page 260)	:FUNCTION:GOFT:OPERat ion? (see page 260)	<operation> ::= {ADD SUBTract MULTiply}
:FUNCTION:GOFT:SOURce 1 <source> (see page 261)	:FUNCTION:GOFT:SOURce 1? (see page 261)	<source> ::= CHANnel<n> <n> ::= {1 2 3 4} for 4ch models <n> ::= {1 2} for 2ch models
:FUNCTION:GOFT:SOURce 2 <source> (see page 262)	:FUNCTION:GOFT:SOURce 2? (see page 262)	<source> ::= CHANnel<n> <n> ::= {{1 2} {3 4}} for 4ch models, depending on SOURce1 selection <n> ::= {1 2} for 2ch models
:FUNCTION:OFFSet <offset> (see page 263)	:FUNCTION:OFFSet? (see page 263)	<offset> ::= the value at center screen in NR3 format. The range of legal values is +/-10 times the current sensitivity of the selected function.
:FUNCTION:OPERation <operation> (see page 264)	:FUNCTION:OPERation? (see page 264)	<operation> ::= {ADD SUBTract MULTiply INTegrate DIFFerentiate FFT SQRT}
:FUNCTION:RANGe <range> (see page 265)	:FUNCTION:RANGe? (see page 265)	<range> ::= the full-scale vertical axis value in NR3 format. The range for ADD, SUBT, MULT is 8E-6 to 800E+3. The range for the INTegrate function is 8E-9 to 400E+3. The range for the DIFFerentiate function is 80E-3 to 8.0E12 (depends on current sweep speed). The range for the FFT function is 8 to 800 dBV.

Table 11 :FUNCTION Commands Summary (continued)

Command	Query	Options and Query Returns
:FUNCTION:REFERENCE <level> (see page 266)	:FUNCTION:REFERENCE? (see page 266)	<level> ::= the value at center screen in NR3 format. The range of legal values is +/-10 times the current sensitivity of the selected function.
:FUNCTION:SCALE <scale value>[<suffix>] (see page 267)	:FUNCTION:SCALE? (see page 267)	<scale value> ::= integer in NR1 format <suffix> ::= {V dB}
:FUNCTION:SOURCE1 <source> (see page 268)	:FUNCTION:SOURCE1? (see page 268)	<source> ::= {CHANNEL<n> GOFT} <n> ::= {1 2 3 4} for 4ch models <n> ::= {1 2} for 2ch models GOFT is only for FFT, INTEGRATE, DIFFERENTIATE, and SQRT operations.
:FUNCTION:SOURCE2 <source> (see page 269)	:FUNCTION:SOURCE2? (see page 269)	<source> ::= {CHANNEL<n> NONE} <n> ::= {{1 2} {3 4}} for 4ch models, depending on SOURCE1 selection <n> ::= {1 2} for 2ch models
:FUNCTION:SPAN (see page 270)	:FUNCTION:SPAN? (see page 270)	 ::= the current frequency span in NR3 format. Legal values are 1 Hz to 100 GHz.
:FUNCTION:WINDOW <window> (see page 271)	:FUNCTION:WINDOW? (see page 271)	<window> ::= {RECTANGULAR HANNING FLATTOP BHARRIS}

Table 12 :HARDcopy Commands Summary

Command	Query	Options and Query Returns
:HARDcopy:AREA <area> (see page 274)	:HARDcopy:AREA? (see page 274)	<area> ::= SCREEN
:HARDcopy:APRINTER <active_printer> (see page 275)	:HARDcopy:APRINTER? (see page 275)	<active_printer> ::= {<index> <name>} <index> ::= integer index of printer in list <name> ::= name of printer in list

4 Commands Quick Reference

Table 12 :HARDcopy Commands Summary (continued)

Command	Query	Options and Query Returns
:HARDcopy:FACTors {{0 OFF} {1 ON}} (see page 276)	:HARDcopy:FACTors? (see page 276)	{0 1}
:HARDcopy:FFeEd {{0 OFF} {1 ON}} (see page 277)	:HARDcopy:FFeEd? (see page 277)	{0 1}
:HARDcopy:INKSaver {{0 OFF} {1 ON}} (see page 278)	:HARDcopy:INKSaver? (see page 278)	{0 1}
:HARDcopy:LAYout <layout> (see page 279)	:HARDcopy:LAYout? (see page 279)	<layout> ::= {LANDscape PORTrait}
:HARDcopy:PAlette <palette> (see page 280)	:HARDcopy:PAlette? (see page 280)	<palette> ::= {COLor GRAYscale NONE}
n/a	:HARDcopy:PRINter:LIST? (see page 281)	<list> ::= [<printer_spec>] ... [printer_spec] <printer_spec> ::= "<index>,<active>,<name>;" <index> ::= integer index of printer <active> ::= {Y N} <name> ::= name of printer
:HARDcopy:STARt (see page 282)	n/a	n/a

Table 13 :MARKer Commands Summary

Command	Query	Options and Query Returns
:MARKer:MODE <mode> (see page 285)	:MARKer:MODE? (see page 285)	<mode> ::= {OFF MEASurement MANual WAVeform}
:MARKer:X1Position <position>[suffix] (see page 286)	:MARKer:X1Position? (see page 286)	<position> ::= X1 cursor position value in NR3 format [suffix] ::= {s ms us ns ps Hz kHz MHz} <return_value> ::= X1 cursor position value in NR3 format
:MARKer:X1Y1source <source> (see page 287)	:MARKer:X1Y1source? (see page 287)	<source> ::= {CHANnel<n> FUNction MATH} <n> ::= 1-2 or 1-4 in NR1 format <return_value> ::= <source>

Table 13 :MARKer Commands Summary (continued)

Command	Query	Options and Query Returns
:MARKer:X2Position <position>[suffix] (see page 288)	:MARKer:X2Position? (see page 288)	<position> ::= X2 cursor position value in NR3 format [suffix] ::= {s ms us ns ps Hz kHz MHz} <return_value> ::= X2 cursor position value in NR3 format
:MARKer:X2Y2source <source> (see page 289)	:MARKer:X2Y2source? (see page 289)	<source> ::= {CHANnel<n> FUNCTION MATH} <n> ::= 1-2 or 1-4 in NR1 format <return_value> ::= <source>
n/a	:MARKer:XDELta? (see page 290)	<return_value> ::= X cursors delta value in NR3 format
:MARKer:Y1Position <position>[suffix] (see page 291)	:MARKer:Y1Position? (see page 291)	<position> ::= Y1 cursor position value in NR3 format [suffix] ::= {V mV dB} <return_value> ::= Y1 cursor position value in NR3 format
:MARKer:Y2Position <position>[suffix] (see page 292)	:MARKer:Y2Position? (see page 292)	<position> ::= Y2 cursor position value in NR3 format [suffix] ::= {V mV dB} <return_value> ::= Y2 cursor position value in NR3 format
n/a	:MARKer:YDELta? (see page 293)	<return_value> ::= Y cursors delta value in NR3 format

Table 14 :MEASure Commands Summary

Command	Query	Options and Query Returns
:MEASure:CLear (see page 302)	n/a	n/a
:MEASure:COUNter [<source>] (see page 303)	:MEASure:COUNter? [<source>] (see page 303)	<source> ::= {CHANnel<n> EXTernal} for DSO models <source> ::= {CHANnel<n> DIGital0,...,DIGital15 EXTernal} for MSO models <n> ::= 1-2 or 1-4 in NR1 format <return_value> ::= counter frequency in Hertz in NR3 format

Table 14 :MEASure Commands Summary (continued)

Command	Query	Options and Query Returns
:MEASure:DEFine DElay, <delay spec> (see page 304)	:MEASure:DEFine? DElay (see page 305)	<delay spec> ::= <edge_spec1>,<edge_spec2> edge_spec1 ::= [<slope>]<occurrence> edge_spec2 ::= [<slope>]<occurrence> <slope> ::= {+ -} <occurrence> ::= integer
:MEASure:DEFine THResholds, <threshold spec> (see page 304)	:MEASure:DEFine? THResholds (see page 305)	<threshold spec> ::= {STANdard} {<threshold mode>,<upper>, <middle>,<lower>} <threshold mode> ::= {PERCent ABSolute}
:MEASure:DElay [<source1>] [,<source2>] (see page 307)	:MEASure:DElay? [<source1>] [,<source2>] (see page 307)	<source1,2> ::= {CHANnel<n> FUNctIon MATH} <n> ::= 1-2 or 1-4 in NR1 format <return_value> ::= floating-point number delay time in seconds in NR3 format
:MEASure:DUTYcycle [<source>] (see page 309)	:MEASure:DUTYcycle? [<source>] (see page 309)	<source> ::= {CHANnel<n> FUNctIon MATH} for DSO models <source> ::= {CHANnel<n> DIGital0,..,DIGital15 FUNctIon MATH} for MSO models <n> ::= 1-2 or 1-4 in NR1 format <return_value> ::= ratio of positive pulse width to period in NR3 format
:MEASure:FALLtime [<source>] (see page 310)	:MEASure:FALLtime? [<source>] (see page 310)	<source> ::= {CHANnel<n> FUNctIon MATH} for DSO models <source> ::= {CHANnel<n> DIGital0,..,DIGital15 FUNctIon MATH} for MSO models <n> ::= 1-2 or 1-4 in NR1 format <return_value> ::= time in seconds between the lower and upper thresholds in NR3 format

Table 14 :MEASure Commands Summary (continued)

Command	Query	Options and Query Returns
:MEASure:FREQuency [<source>] (see page 311)	:MEASure:FREQuency? [<source>] (see page 311)	<source> ::= {CHANnel<n> FUNctIon MATH} for DSO models <source> ::= {CHANnel<n> DIGital0,..,DIGital15 FUNctIon MATH} for MSO models <n> ::= 1-2 or 1-4 in NR1 format <return_value> ::= frequency in Hertz in NR3 format
:MEASure:NWIDth [<source>] (see page 312)	:MEASure:NWIDth? [<source>] (see page 312)	<source> ::= {CHANnel<n> FUNctIon MATH} for DSO models <source> ::= {CHANnel<n> DIGital0,..,DIGital15 FUNctIon MATH} for MSO models <n> ::= 1-2 or 1-4 in NR1 format <return_value> ::= negative pulse width in seconds-NR3 format
:MEASure:OVERshoot [<source>] (see page 313)	:MEASure:OVERshoot? [<source>] (see page 313)	<source> ::= {CHANnel<n> FUNctIon MATH} <n> ::= 1-2 or 1-4 in NR1 format <return_value> ::= the percent of the overshoot of the selected waveform in NR3 format
:MEASure:PERiod [<source>] (see page 315)	:MEASure:PERiod? [<source>] (see page 315)	<source> ::= {CHANnel<n> FUNctIon MATH} for DSO models <source> ::= {CHANnel<n> DIGital0,..,DIGital15 FUNctIon MATH} for MSO models <n> ::= 1-2 or 1-4 in NR1 format <return_value> ::= waveform period in seconds in NR3 format
:MEASure:PHASe [<source1>] [,<source2>] (see page 316)	:MEASure:PHASe? [<source1>] [,<source2>] (see page 316)	<source1,2> ::= {CHANnel<n> FUNctIon MATH} <n> ::= 1-2 or 1-4 in NR1 format <return_value> ::= the phase angle value in degrees in NR3 format
:MEASure:PREShoot [<source>] (see page 317)	:MEASure:PREShoot? [<source>] (see page 317)	<source> ::= {CHANnel<n> FUNctIon MATH} <n> ::= 1-2 or 1-4 in NR1 format <return_value> ::= the percent of preshoot of the selected waveform in NR3 format

Table 14 :MEASure Commands Summary (continued)

Command	Query	Options and Query Returns
:MEASure:PWIDth [<source>] (see page 318)	:MEASure:PWIDth? [<source>] (see page 318)	<source> ::= {CHANnel<n> FUNctIon MATH} for DSO models <source> ::= {CHANnel<n> DIGital0,..,DIGital15 FUNctIon MATH} for MSO models <n> ::= 1-2 or 1-4 in NR1 format <return_value> ::= width of positive pulse in seconds in NR3 format
n/a	:MEASure:RESults? <result_list> (see page 319)	<result_list> ::= comma-separated list of measurement results
:MEASure:RISEtime [<source>] (see page 322)	:MEASure:RISEtime? [<source>] (see page 322)	<source> ::= {CHANnel<n> FUNctIon MATH} <n> ::= 1-2 or 1-4 in NR1 format <return_value> ::= rise time in seconds in NR3 format
:MEASure:SDEVIation [<source>] (see page 323)	:MEASure:SDEVIation? [<source>] (see page 323)	<source> ::= {CHANnel<n> FUNctIon MATH} <n> ::= 1-2 or 1-4 in NR1 format <return_value> ::= calculated std deviation in NR3 format
:MEASure:SHOW {1 ON} (see page 324)	:MEASure:SHOW? (see page 324)	{1}
:MEASure:SOURce <source1> [,<source2>] (see page 325)	:MEASure:SOURce? (see page 325)	<source1,2> ::= {CHANnel<n> FUNctIon MATH EXtErnal} for DSO models <source1,2> ::= {CHANnel<n> DIGital0,..,DIGital15 FUNctIon MATH EXtErnal} for MSO models <n> ::= 1-2 or 1-4 in NR1 format <return_value> ::= {<source> NONE}
:MEASure:STATistics <type> (see page 327)	:MEASure:STATistics? (see page 327)	<type> ::= {{ON 1} CURrent MEAN MINimum MAXimum STDDev COUNT} ON ::= all statistics returned
:MEASure:STATistics:I NCRement (see page 328)	n/a	n/a
:MEASure:STATistics:R ESet (see page 329)	n/a	n/a

Table 14 :MEASure Commands Summary (continued)

Command	Query	Options and Query Returns
n/a	:MEASure:TEDGE? <slope><occurrence>[, <source>] (see page 330)	<slope> ::= direction of the waveform <occurrence> ::= the transition to be reported <source> ::= {CHANnel<n> FUNctIon MATH} for DSO models <source> ::= {CHANnel<n> DIGital0,..,DIGital15 FUNctIon MATH} for MSO models <n> ::= 1-2 or 1-4 in NR1 format <return_value> ::= time in seconds of the specified transition
n/a	:MEASure:TVALUE? <value>, [<slope>]<occurrence> [,<source>] (see page 332)	<value> ::= voltage level that the waveform must cross. <slope> ::= direction of the waveform when <value> is crossed. <occurrence> ::= transitions reported. <return_value> ::= time in seconds of specified voltage crossing in NR3 format <source> ::= {CHANnel<n> FUNctIon MATH} for DSO models <source> ::= {CHANnel<n> DIGital0,..,DIGital15 FUNctIon MATH} for MSO models <n> ::= 1-2 or 1-4 in NR1 format
:MEASure:VAMPLitude [<source>] (see page 334)	:MEASure:VAMPLitude? [<source>] (see page 334)	<source> ::= {CHANnel<n> FUNctIon MATH} <n> ::= 1-2 or 1-4 in NR1 format <return_value> ::= the amplitude of the selected waveform in volts in NR3 format
:MEASure:VAverage [<source>] (see page 335)	:MEASure:VAverage? [<source>] (see page 335)	<source> ::= {CHANnel<n> FUNctIon MATH} <n> ::= 1-2 or 1-4 in NR1 format <return_value> ::= calculated average voltage in NR3 format

Table 14 :MEASure Commands Summary (continued)

Command	Query	Options and Query Returns
:MEASure:VBASe [<source>] (see page 336)	:MEASure:VBASe? [<source>] (see page 336)	<source> ::= {CHANnel<n> FUNction MATH} <n> ::= 1-2 or 1-4 in NR1 format <base_voltage> ::= voltage at the base of the selected waveform in NR3 format
:MEASure:VMAX [<source>] (see page 337)	:MEASure:VMAX? [<source>] (see page 337)	<source> ::= {CHANnel<n> FUNction MATH} <n> ::= 1-2 or 1-4 in NR1 format <return_value> ::= maximum voltage of the selected waveform in NR3 format
:MEASure:VMIN [<source>] (see page 338)	:MEASure:VMIN? [<source>] (see page 338)	<source> ::= {CHANnel<n> FUNction MATH} <n> ::= 1-2 or 1-4 in NR1 format <return_value> ::= minimum voltage of the selected waveform in NR3 format
:MEASure:VPP [<source>] (see page 339)	:MEASure:VPP? [<source>] (see page 339)	<source> ::= {CHANnel<n> FUNction MATH} <n> ::= 1-2 or 1-4 in NR1 format <return_value> ::= voltage peak-to-peak of the selected waveform in NR3 format
:MEASure:VRATio [<source1>] [,<source2>] (see page 316)	:MEASure:VRATio? [<source1>] [,<source2>] (see page 340)	<source1,2> ::= {CHANnel<n> FUNction MATH} <n> ::= 1-2 or 1-4 in NR1 format <return_value> ::= the ratio value in dB in NR3 format
:MEASure:VRMS [<source>] (see page 341)	:MEASure:VRMS? [<source>] (see page 341)	<source> ::= {CHANnel<n> FUNction MATH} <n> ::= 1-2 or 1-4 in NR1 format <return_value> ::= calculated dc RMS voltage in NR3 format

Table 14 :MEASure Commands Summary (continued)

Command	Query	Options and Query Returns
n/a	:MEASure:VTime? <vtime>[,<source>] (see page 342)	<vtime> ::= displayed time from trigger in seconds in NR3 format <return_value> ::= voltage at the specified time in NR3 format <source> ::= {CHANnel<n> FUNCTION MATH} for DSO models <source> ::= {CHANnel<n> DIGital0,..,DIGital15 FUNCTION MATH} for MSO models <n> ::= 1-2 or 1-4 in NR1 format
:MEASure:VTOP [<source>] (see page 343)	:MEASure:VTOP? [<source>] (see page 343)	<source> ::= {CHANnel<n> FUNCTION MATH} <n> ::= 1-2 or 1-4 in NR1 format <return_value> ::= voltage at the top of the waveform in NR3 format
:MEASure:XMAX [<source>] (see page 344)	:MEASure:XMAX? [<source>] (see page 344)	<source> ::= {CHANnel<n> FUNCTION MATH} <n> ::= 1-2 or 1-4 in NR1 format <return_value> ::= horizontal value of the maximum in NR3 format
:MEASure:XMIN [<source>] (see page 345)	:MEASure:XMIN? [<source>] (see page 345)	<source> ::= {CHANnel<n> FUNCTION MATH} <n> ::= 1-2 or 1-4 in NR1 format <return_value> ::= horizontal value of the maximum in NR3 format

Table 15 :MTEST Commands Summary

Command	Query	Options and Query Returns
:MTEST:AMASK:CREate (see page 351)	n/a	n/a
:MTEST:AMASK:SOURce <source> (see page 352)	:MTEST:AMASK:SOURce? (see page 352)	<source> ::= CHANnel<n> <n> ::= {1 2 3 4} for 4ch models <n> ::= {1 2} for 2ch models
:MTEST:AMASK:UNITs <units> (see page 353)	:MTEST:AMASK:UNITs? (see page 353)	<units> ::= {CURRENT DIVisions}

4 Commands Quick Reference

Table 15 :MTESt Commands Summary (continued)

Command	Query	Options and Query Returns
:MTESt:AMASk:XDELta <value> (see page 354)	:MTESt:AMASk:XDELta? (see page 354)	<value> ::= X delta value in NR3 format
:MTESt:AMASk:YDELta <value> (see page 355)	:MTESt:AMASk:YDELta? (see page 355)	<value> ::= Y delta value in NR3 format
n/a	:MTESt:COUNT:FWAVEfor ms? [CHANnel<n>] (see page 356)	<failed> ::= number of failed waveforms in NR1 format
:MTESt:COUNT:RESet (see page 357)	n/a	n/a
n/a	:MTESt:COUNT:TIME? (see page 358)	<time> ::= elapsed seconds in NR3 format
n/a	:MTESt:COUNT:WAVEform s? (see page 359)	<count> ::= number of waveforms in NR1 format
:MTESt:DATA <mask> (see page 360)	:MTESt:DATA? (see page 360)	<mask> ::= data in IEEE 488.2 # format.
:MTESt:DELeTe (see page 361)	n/a	n/a
:MTESt:ENABLe {{0 OFF} {1 ON}} (see page 362)	:MTESt:ENABLe? (see page 362)	{0 1}
:MTESt:LOCK {{0 OFF} {1 ON}} (see page 363)	:MTESt:LOCK? (see page 363)	{0 1}
:MTESt:OUTPut <signal> (see page 364)	:MTESt:OUTPut? (see page 364)	<signal> ::= {FAIL PASS}
:MTESt:RMODE <rmode> (see page 365)	:MTESt:RMODE? (see page 365)	<rmode> ::= {FORever TIME SIGMa WAVEforms}
:MTESt:RMODE:FACTION: PRINT {{0 OFF} {1 ON}} (see page 366)	:MTESt:RMODE:FACTION: PRINT? (see page 366)	{0 1}
:MTESt:RMODE:FACTION: SAVE {{0 OFF} {1 ON}} (see page 367)	:MTESt:RMODE:FACTION: SAVE? (see page 367)	{0 1}
:MTESt:RMODE:FACTION: STOP {{0 OFF} {1 ON}} (see page 368)	:MTESt:RMODE:FACTION: STOP? (see page 368)	{0 1}

Table 15 :MTESt Commands Summary (continued)

Command	Query	Options and Query Returns
:MTESt:RMODE:SIGMa <level> (see page 369)	:MTESt:RMODE:SIGMa? (see page 369)	<level> ::= from 0.1 to 9.3 in NR3 format
:MTESt:RMODE:TIME <seconds> (see page 370)	:MTESt:RMODE:TIME? (see page 370)	<seconds> ::= from 1 to 86400 in NR3 format
:MTESt:RMODE:WAVEform s <count> (see page 371)	:MTESt:RMODE:WAVEform s? (see page 371)	<count> ::= number of waveforms in NR1 format
:MTESt:SCALE:BIND {{0 OFF}} {{1 ON}} (see page 372)	:MTESt:SCALE:BIND? (see page 372)	{0 1}
:MTESt:SCALE:X1 <x1_value> (see page 373)	:MTESt:SCALE:X1? (see page 373)	<x1_value> ::= X1 value in NR3 format
:MTESt:SCALE:XDELta <xdelta_value> (see page 374)	:MTESt:SCALE:XDELta? (see page 374)	<xdelta_value> ::= X delta value in NR3 format
:MTESt:SCALE:Y1 <y1_value> (see page 375)	:MTESt:SCALE:Y1? (see page 375)	<y1_value> ::= Y1 value in NR3 format
:MTESt:SCALE:Y2 <y2_value> (see page 376)	:MTESt:SCALE:Y2? (see page 376)	<y2_value> ::= Y2 value in NR3 format
:MTESt:SOURce <source> (see page 377)	:MTESt:SOURce? (see page 377)	<source> ::= {CHANnel<n> NONE} <n> ::= {1 2 3 4} for 4ch models <n> ::= {1 2} for 2ch models
n/a	:MTESt:TITLe? (see page 378)	<title> ::= a string of up to 128 ASCII characters

Table 16 :POD<n> Commands Summary

Command	Query	Options and Query Returns
:POD<n>:DISPlay {{0 OFF}} {{1 ON}} (see page 380)	:POD<n>:DISPlay? (see page 380)	{0 1} <n> ::= 1-2 in NR1 format

4 Commands Quick Reference

Table 16 :POD<n> Commands Summary (continued)

Command	Query	Options and Query Returns
:POD<n>:SIZE <value> (see page 381)	:POD<n>:SIZE? (see page 381)	<value> ::= {SMALl MEDium LARGe}
:POD<n>:THReshold <type>[suffix] (see page 382)	:POD<n>:THReshold? (see page 382)	<n> ::= 1-2 in NR1 format <type> ::= {CMOS ECL TTL <user defined value>} <user defined value> ::= value in NR3 format [suffix] ::= {V mV uV }

Table 17 :RECall Commands Summary

Command	Query	Options and Query Returns
:RECall:FIleName <base_name> (see page 385)	:RECall:FIleName? (see page 385)	<base_name> ::= quoted ASCII string
:RECall:IMAGe[:START] [<file_spec>] (see page 386)	n/a	<file_spec> ::= {<internal_loc> <file_name>} <internal_loc> ::= 0-9; an integer in NR1 format <file_name> ::= quoted ASCII string
:RECall:MASK[:START] [<file_spec>] (see page 387)	n/a	<file_spec> ::= {<internal_loc> <file_name>} <internal_loc> ::= 0-3; an integer in NR1 format <file_name> ::= quoted ASCII string
:RECall:PWD <path_name> (see page 388)	:RECall:PWD? (see page 388)	<path_name> ::= quoted ASCII string
:RECall:SETup[:START] [<file_spec>] (see page 389)	n/a	<file_spec> ::= {<internal_loc> <file_name>} <internal_loc> ::= 0-9; an integer in NR1 format <file_name> ::= quoted ASCII string

Table 18 :SAVE Commands Summary

Command	Query	Options and Query Returns
:SAVE:FILEname <base_name> (see page 392)	:SAVE:FILEname? (see page 392)	<base_name> ::= quoted ASCII string
:SAVE:IMAGe[:START] [<file_spec>] (see page 393)	n/a	<file_spec> ::= {<internal_loc> <file_name>} <internal_loc> ::= 0-9; an integer in NR1 format <file_name> ::= quoted ASCII string
n/a	:SAVE:IMAGe:AREA? (see page 394)	<area> ::= {GRAT SCR}
:SAVE:IMAGe:FACTors {0 OFF} {1 ON}} (see page 395)	:SAVE:IMAGe:FACTors? (see page 395)	{0 1}
:SAVE:IMAGe:FORMat <format> (see page 396)	:SAVE:IMAGe:FORMat? (see page 396)	<format> ::= {TIFF {BMP BMP24bit} BMP8bit PNG NONE}
:SAVE:IMAGe:INKSaver {0 OFF} {1 ON}} (see page 397)	:SAVE:IMAGe:INKSaver? (see page 397)	{0 1}
:SAVE:IMAGe:PALette <palette> (see page 398)	:SAVE:IMAGe:PALette? (see page 398)	<palette> ::= {COLor GRAYscale MONochrome}
:SAVE:MASK[:START] [<file_spec>] (see page 399)	n/a	<file_spec> ::= {<internal_loc> <file_name>} <internal_loc> ::= 0-3; an integer in NR1 format <file_name> ::= quoted ASCII string
:SAVE:PWD <path_name> (see page 400)	:SAVE:PWD? (see page 400)	<path_name> ::= quoted ASCII string
:SAVE:SETup[:START] [<file_spec>] (see page 401)	n/a	<file_spec> ::= {<internal_loc> <file_name>} <internal_loc> ::= 0-9; an integer in NR1 format <file_name> ::= quoted ASCII string
:SAVE:WAVEform[:START] [<file_name>] (see page 402)	n/a	<file_name> ::= quoted ASCII string

4 Commands Quick Reference

Table 18 :SAVE Commands Summary (continued)

Command	Query	Options and Query Returns
:SAVE:WAVEform:FORMat <format> (see page 403)	:SAVE:WAVEform:FORMat ? (see page 403)	<format> ::= {ALB ASCiixy CSV BINary NONE}
:SAVE:WAVEform:LENGth <length> (see page 404)	:SAVE:WAVEform:LENGth ? (see page 404)	<length> ::= 100 to max. length; an integer in NR1 format
:SAVE:WAVEform:SEGMen ted <option> (see page 405)	:SAVE:WAVEform:SEGMen ted? (see page 405)	<option> ::= {ALL CURRent}

Table 19 :SBUS Commands Summary

Command	Query	Options and Query Returns
:SBUS:BUSDoctor:ADDRe ss <value> (see page 409)	:SBUS:BUSDoctor:ADDRe ss? (see page 409)	<value> ::= <field value>, <field value>, <field value>, <field value> <field value> ::= integer from 0-255 in NR1 format
:SBUS:BUSDoctor:BAUDr ate <baudrate> (see page 410)	:SBUS:BUSDoctor:BAUDr ate? (see page 410)	<baudrate> ::= {2500000 5000000 10000000}
:SBUS:BUSDoctor:CHANn el <channel> (see page 411)	:SBUS:BUSDoctor:CHANn el? (see page 411)	<channel> ::= {A B}
:SBUS:BUSDoctor:MODE <mode> (see page 412)	:SBUS:BUSDoctor:MODE? (see page 412)	<mode> ::= {ASYNchronous SYNchronous PC}
n/a	:SBUS:CAN:COUNT:ERRor ? (see page 413)	<frame_count> ::= integer in NR1 format
n/a	:SBUS:CAN:COUNT:OVERl oad? (see page 414)	<frame_count> ::= integer in NR1 format
:SBUS:CAN:COUNT:RESet (see page 415)	n/a	n/a
n/a	:SBUS:CAN:COUNT:TOTAl ? (see page 416)	<frame_count> ::= integer in NR1 format
n/a	:SBUS:CAN:COUNT:UTILi zation? (see page 417)	<percent> ::= floating-point in NR3 format
:SBUS:DISPlay {{0 OFF} {1 ON}} (see page 418)	:SBUS:DISPlay? (see page 418)	{0 1}

Table 19 :SBUS Commands Summary (continued)

Command	Query	Options and Query Returns
n/a	:SBUS:FLEXray:COUNT:N ULL? (see page 419)	<frame_count> ::= integer in NR1 format
:SBUS:FLEXray:COUNT:R ESet (see page 420)	n/a	n/a
n/a	:SBUS:FLEXray:COUNT:S YNC? (see page 421)	<frame_count> ::= integer in NR1 format
n/a	:SBUS:FLEXray:COUNT:T OTal? (see page 422)	<frame_count> ::= integer in NR1 format
:SBUS:IIC:ASIZe <size> (see page 423)	:SBUS:IIC:ASIZE? (see page 423)	<size> ::= {BIT7 BIT8}
:SBUS:LIN:PARity {{0 OFF} {1 ON}} (see page 424)	:SBUS:LIN:PARity? (see page 424)	{0 1}
:SBUS:MODE <mode> (see page 425)	:SBUS:MODE? (see page 425)	<mode> ::= {IIC SPI CAN LIN FLEXray UART}
:SBUS:SPI:WIDTh <word_width> (see page 426)	:SBUS:SPI:WIDTH? (see page 426)	<word_width> ::= integer 4-16 in NR1 format
:SBUS:UART:BASE <base> (see page 427)	:SBUS:UART:BASE? (see page 427)	<base> ::= {ASCIi BINary HEX}
n/a	:SBUS:UART:COUNT:ERRO r? (see page 428)	<frame_count> ::= integer in NR1 format
:SBUS:UART:COUNT:RESe t (see page 429)	n/a	n/a
n/a	:SBUS:UART:COUNT:RXFR ames? (see page 430)	<frame_count> ::= integer in NR1 format
n/a	:SBUS:UART:COUNT:TXFR ames? (see page 431)	<frame_count> ::= integer in NR1 format
:SBUS:UART:FRAMing <value> (see page 432)	:SBUS:UART:FRAMing? (see page 432)	<value> ::= {OFF <decimal> <nondecimal>} <decimal> ::= 8-bit integer from 0-255 (0x00-0xff) <nondecimal> ::= #Hnn where n ::= {0,...,9 A,...,F} for hexadecimal <nondecimal> ::= #Bnn...n where n ::= {0 1} for binary

4 Commands Quick Reference

Table 20 :SYSTem Commands Summary

Command	Query	Options and Query Returns
:SYSTem:DATE <date> (see page 434)	:SYSTem:DATE? (see page 434)	<date> ::= <year>, <month>, <day> <year> ::= 4-digit year in NR1 format <month> ::= {1,...,12 JANuary FEBruary MARCH APRil MAY JUNE JULy AUGust SEPtember OCTober NOVember DECember} <day> ::= {1,..31}
:SYSTem:DSP <string> (see page 435)	n/a	<string> ::= up to 254 characters as a quoted ASCII string
n/a	:SYSTem:ERRor? (see page 436)	<error> ::= an integer error code <error string> ::= quoted ASCII string. See Error Messages (see page 697).
:SYSTem:LOCK <value> (see page 437)	:SYSTem:LOCK? (see page 437)	<value> ::= {{1 ON} {0 OFF}}
:SYSTem:PROTection:LOCK <value> (see page 438)	:SYSTem:PROTection:LOCK? (see page 438)	<value> ::= {{1 ON} {0 OFF}}
:SYSTem:SETup <setup_data> (see page 439)	:SYSTem:SETup? (see page 439)	<setup_data> ::= data in IEEE 488.2 # format.
:SYSTem:TIME <time> (see page 441)	:SYSTem:TIME? (see page 441)	<time> ::= hours, minutes, seconds in NR1 format

Table 21 :TIMebase Commands Summary

Command	Query	Options and Query Returns
:TIMebase:MODE <value> (see page 444)	:TIMebase:MODE? (see page 444)	<value> ::= {MAIN WINDow XY ROLL}
:TIMebase:POSition <pos> (see page 445)	:TIMebase:POSition? (see page 445)	<pos> ::= time from the trigger event to the display reference point in NR3 format
:TIMebase:RANGe <range_value> (see page 446)	:TIMebase:RANGe? (see page 446)	<range_value> ::= 5 ns through 500 s in NR3 format

Table 21 :TIMEbase Commands Summary (continued)

Command	Query	Options and Query Returns
:TIMEbase:REFClock {0 OFF} {1 ON}} (see page 447)	:TIMEbase:REFClock? (see page 447)	{0 1}
:TIMEbase:REference {LEFT CENTER RIGHT} (see page 448)	:TIMEbase:REFERENCE? (see page 448)	<return_value> ::= {LEFT CENTER RIGHT}
:TIMEbase:SCALE <scale_value> (see page 449)	:TIMEbase:SCALE? (see page 449)	<scale_value> ::= scale value in seconds in NR3 format
:TIMEbase:VERNier {{0 OFF} {1 ON}} (see page 450)	:TIMEbase:VERNier? (see page 450)	{0 1}
:TIMEbase:WINDOW:POSITION <pos> (see page 451)	:TIMEbase:WINDOW:POSITION? (see page 451)	<pos> ::= time from the trigger event to the zoomed view reference point in NR3 format
:TIMEbase:WINDOW:RANGE <range_value> (see page 452)	:TIMEbase:WINDOW:RANGE? (see page 452)	<range_value> ::= range value in seconds in NR3 format for the zoomed window
:TIMEbase:WINDOW:SCALE <scale_value> (see page 453)	:TIMEbase:WINDOW:SCALE? (see page 453)	<scale_value> ::= scale value in seconds in NR3 format for the zoomed window

Table 22 General :TRIGger Commands Summary

Command	Query	Options and Query Returns
:TRIGger:HFReject {{0 OFF} {1 ON}} (see page 458)	:TRIGger:HFReject? (see page 458)	{0 1}
:TRIGger:HOLDoff <holdoff_time> (see page 459)	:TRIGger:HOLDoff? (see page 459)	<holdoff_time> ::= 60 ns to 10 s in NR3 format
:TRIGger:MODE <mode> (see page 460)	:TRIGger:MODE? (see page 460)	<mode> ::= {EDGE GLITCh PATtern CAN DURation IIC EBURst LIN SEQuence SPI TV USB FLEXray} <return_value> ::= {<mode> <none>} <none> ::= query returns "NONE" if the :TIMEbase:MODE is ROLL or XY

4 Commands Quick Reference

Table 22 General :TRIGger Commands Summary (continued)

Command	Query	Options and Query Returns
:TRIGger:NREJect {{0 OFF} {1 ON}} (see page 461)	:TRIGger:NREJect? (see page 461)	{0 1}
:TRIGger:PATtern <value>, <mask> [, <edge source>, <edge>] (see page 462)	:TRIGger:PATtern? (see page 463)	<value> ::= integer in NR1 format or <string> <mask> ::= integer in NR1 format or <string> <string> ::= "0xnxxxxn"; n ::= {0,...,9 A,...,F} (# bits = # channels) <edge source> ::= {CHANnel<n> EXTernal NONE} for DSO models <edge source> ::= {CHANnel<n> DIGital0,...,DIGital15 NONE} for MSO models <edge> ::= {POSitive NEGative} <n> ::= 1-2 or 1-4 in NR1 format
:TRIGger:SWEep <sweep> (see page 464)	:TRIGger:SWEep? (see page 464)	<sweep> ::= {AUTO NORMal}

Table 23 :TRIGger:CAN Commands Summary

Command	Query	Options and Query Returns
:TRIGger:CAN:PATtern:DATA <value>, <mask> (see page 467)	:TRIGger:CAN:PATtern:DATA? (see page 467)	<value> ::= 64-bit integer in decimal, <nondecimal>, or <string> (with Option AMS) <mask> ::= 64-bit integer in decimal, <nondecimal>, or <string> <nondecimal> ::= #Hnn...n where n ::= {0,...,9 A,...,F} for hexadecimal <nondecimal> ::= #Bnn...n where n ::= {0 1} for binary <string> ::= "0xnn...n" where n ::= {0,...,9 A,...,F} for hexadecimal
:TRIGger:CAN:PATtern:DATA:LENGth <length> (see page 468)	:TRIGger:CAN:PATtern:DATA:LENGth? (see page 468)	<length> ::= integer from 1 to 8 in NR1 format (with Option AMS)

Table 23 :TRIGger:CAN Commands Summary (continued)

Command	Query	Options and Query Returns
:TRIGger:CAN:PATtern: ID <value>, <mask> (see page 469)	:TRIGger:CAN:PATtern: ID? (see page 469)	<value> ::= 32-bit integer in decimal, <nondecimal>, or <string> (with Option AMS) <mask> ::= 32-bit integer in decimal, <nondecimal>, or <string> <nondecimal> ::= #Hnn...n where n ::= {0,...,9 A,...,F} for hexadecimal <nondecimal> ::= #Bnn...n where n ::= {0 1} for binary <string> ::= "0xnn...n" where n ::= {0,...,9 A,...,F} for hexadecimal
:TRIGger:CAN:PATtern: ID:MODE <value> (see page 470)	:TRIGger:CAN:PATtern: ID:MODE? (see page 470)	<value> ::= {STANDARD EXTENDED} (with Option AMS)
:TRIGger:CAN:SAMPlepo int <value> (see page 471)	:TRIGger:CAN:SAMPlepo int? (see page 471)	<value> ::= {60 62.5 68 70 75 80 87.5} in NR3 format
:TRIGger:CAN:SIGNAL:B AUDrate <baudrate> (see page 472)	:TRIGger:CAN:SIGNAL:B AUDrate? (see page 472)	<baudrate> ::= integer from 10000 to 1000000 in 100 b/s increments
:TRIGger:CAN:SOURce <source> (see page 473)	:TRIGger:CAN:SOURce? (see page 473)	<source> ::= {CHANNEL<n> EXTERNAL} for DSO models <source> ::= {CHANNEL<n> DIGital0,...,DIGital15 } for MSO models <n> ::= 1-2 or 1-4 in NR1 format
:TRIGger:CAN:TRIGger <condition> (see page 474)	:TRIGger:CAN:TRIGger? (see page 475)	<condition> ::= {SOF} (without Option AMS) <condition> ::= {SOF DATA ERROR IDData IDEither IDRemote ALLerrors OVERload ACKerror} (with Option AMS)

4 Commands Quick Reference

Table 24 :TRIGger:DURation Commands Summary

Command	Query	Options and Query Returns
:TRIGger:DURation:GREaterthan <greater than time>[suffix] (see page 477)	:TRIGger:DURation:GREaterthan? (see page 477)	<greater_than_time> ::= floating-point number in NR3 format [suffix] ::= {s ms us ns ps}
:TRIGger:DURation:LESSthan <less than time>[suffix] (see page 478)	:TRIGger:DURation:LESSthan? (see page 478)	<less_than_time> ::= floating-point number from in NR3 format [suffix] ::= {s ms us ns ps}
:TRIGger:DURation:PATtern <value>, <mask> (see page 479)	:TRIGger:DURation:PATtern? (see page 479)	<value> ::= integer or <string> <mask> ::= integer or <string> <string> ::= "0xnxxxxnn" n ::= {0,...,9 A,...,F}
:TRIGger:DURation:QUALifier <qualifier> (see page 480)	:TRIGger:DURation:QUALifier? (see page 480)	<qualifier> ::= {GREaterthan LESSthan INRange OUTRange TIMEout}
:TRIGger:DURation:RANGe <less_than_time>[suffix], <greater_than_time>[suffix] (see page 481)	:TRIGger:DURation:RANGe? (see page 481)	<less_than_time> ::= 15 ns to 10 seconds in NR3 format <greater_than_time> ::= 10 ns to 9.99 seconds in NR3 format [suffix] ::= {s ms us ns ps}

Table 25 :TRIGger:EBURst Commands Summary

Command	Query	Options and Query Returns
:TRIGger:EBURst:COUNT <count> (see page 483)	:TRIGger:EBURst:COUNT? (see page 483)	<count> ::= integer in NR1 format
:TRIGger:EBURst:IDLE <time_value> (see page 484)	:TRIGger:EBURst:IDLE? (see page 484)	<time_value> ::= time in seconds in NR3 format
:TRIGger:EBURst:SLOPe <slope> (see page 485)	:TRIGger:EBURst:SLOPe? (see page 485)	<slope> ::= {NEGative POSitive}

Table 26 :TRIGger[:EDGE] Commands Summary

Command	Query	Options and Query Returns
:TRIGger[:EDGE]:COUPling {AC DC LF} (see page 487)	:TRIGger[:EDGE]:COUPling? (see page 487)	{AC DC LF}
:TRIGger[:EDGE]:LEVEl <level> [, <source>] (see page 488)	:TRIGger[:EDGE]:LEVEl ? [<source>] (see page 488)	For internal triggers, <level> ::= .75 x full-scale voltage from center screen in NR3 format. For external triggers, <level> ::= ±(external range setting) in NR3 format. For digital channels (MSO models), <level> ::= ±8 V. <source> ::= {CHANnel<n> EXTErnal} for DSO models <source> ::= {CHANnel<n> DIGital0,...,DIGital15 EXTErnal} for MSO models <n> ::= 1-2 or 1-4 in NR1 format
:TRIGger[:EDGE]:REJect {OFF LF HF} (see page 489)	:TRIGger[:EDGE]:REJect? (see page 489)	{OFF LF HF}
:TRIGger[:EDGE]:SLOPe <polarity> (see page 490)	:TRIGger[:EDGE]:SLOPe ? (see page 490)	<polarity> ::= {POSitive NEGative EITHer ALTErnate}
:TRIGger[:EDGE]:SOURcE <source> (see page 491)	:TRIGger[:EDGE]:SOURcE? (see page 491)	<source> ::= {CHANnel<n> EXTErnal} for DSO models <source> ::= {CHANnel<n> DIGital0,...,DIGital15 EXTErnal} for MSO models <n> ::= 1-2 or 1-4 in NR1 format

Table 27 :TRIGger:FLEXray Commands Summary

Command	Query	Options and Query Returns
:TRIGger:FLEXray:ERRor:TYPE <error_type> (see page 493)	:TRIGger:FLEXray:ERRor:TYPE? (see page 493)	<error_type> ::= {ALL CODE TSS HCRC FCRC END BOUNDary IDLE SYMbol SLOT NULL SOS FID CCOUNT PLENgth}
:TRIGger:FLEXray:FRAMe:CCBase <cycle_count_base> (see page 495)	:TRIGger:FLEXray:FRAMe:CCBase? (see page 495)	<cycle_count_base> ::= integer from 0-63

4 Commands Quick Reference

Table 27 :TRIGger:FLEXray Commands Summary (continued)

Command	Query	Options and Query Returns
:TRIGger:FLEXray:FRAME:CCRepetition <cycle_count_repetition> (see page 496)	:TRIGger:FLEXray:FRAME:CCRepetition? (see page 496)	<cycle_count_repetition> ::= {ALL <rep #>} <rep #> ::= integer from 2-64
:TRIGger:FLEXray:FRAME:ID <frame_id> (see page 497)	:TRIGger:FLEXray:FRAME:ID? (see page 497)	<frame_id> ::= {ALL <frame #>} <frame #> ::= integer from 1-2047
:TRIGger:FLEXray:FRAME:TYPE <frame_type> (see page 498)	:TRIGger:FLEXray:FRAME:TYPE? (see page 498)	<frame_type> ::= {NORMAL STARTup NULL SYNC NSTARTup NNUL1 NSYNc ALL}
:TRIGger:FLEXray:TIME:CBASE <cycle_base> (see page 499)	:TRIGger:FLEXray:TIME:CBASE? (see page 499)	<cycle_base> ::= integer from 0-63
:TRIGger:FLEXray:TIME:CREPpetition <cycle_repetition> (see page 500)	:TRIGger:FLEXray:TIME:CREPpetition? (see page 500)	<cycle_repetition> ::= {ALL <rep #>} <rep #> ::= integer from 2-64
:TRIGger:FLEXray:TIME:SEGMENT <segment_type> (see page 501)	:TRIGger:FLEXray:TIME:SEGMENT? (see page 501)	<segment_type> ::= {STATIC DYNAMIC SYMBOL IDLE}
:TRIGger:FLEXray:TIME:SLOT <slot_type>, <slot_id> (see page 502)	:TRIGger:FLEXray:TIME:SLOT? (see page 502)	<slot_type> ::= {ALL EMPTY} <slot_id> ::= {ALL <slot #>} <slot #> ::= integer from 1-2047
:TRIGger:FLEXray:TRIGger <condition> (see page 503)	:TRIGger:FLEXray:TRIGger? (see page 503)	<condition> ::= {FRAME TIME ERROR}

Table 28 :TRIGger:GLITCh Commands Summary

Command	Query	Options and Query Returns
:TRIGger:GLITCh:GREAt erthan <greater_than_time>[suffix] (see page 506)	:TRIGger:GLITCh:GREAt erthan? (see page 506)	<greater_than_time> ::= floating-point number in NR3 format [suffix] ::= {s ms us ns ps}
:TRIGger:GLITCh:LESSt han <less_than_time>[suffix] (see page 507)	:TRIGger:GLITCh:LESSt han? (see page 507)	<less_than_time> ::= floating-point number in NR3 format [suffix] ::= {s ms us ns ps}

Table 28 :TRIGger:GLITch Commands Summary (continued)

Command	Query	Options and Query Returns
:TRIGger:GLITch:LEVel <level> [<source>] (see page 508)	:TRIGger:GLITch:LEVel ? (see page 508)	For internal triggers, <level> ::= .75 x full-scale voltage from center screen in NR3 format. For external triggers (DSO models), <level> ::= ±(external range setting) in NR3 format. For digital channels (MSO models), <level> ::= ±8 V. <source> ::= {CHANnel<n> EXTernal} for DSO models <source> ::= {CHANnel<n> DIGital0,...,DIGital15} for MSO models <n> ::= 1-2 or 1-4 in NR1 format
:TRIGger:GLITch:POLarity <polarity> (see page 509)	:TRIGger:GLITch:POLarity? (see page 509)	<polarity> ::= {POSitive NEGative}
:TRIGger:GLITch:QUALifier <qualifier> (see page 510)	:TRIGger:GLITch:QUALifier? (see page 510)	<qualifier> ::= {GREATERthan LESSthan RANGE}
:TRIGger:GLITch:RANGE <less_than_time>[suffix], <greater_than_time>[suffix] (see page 511)	:TRIGger:GLITch:RANGE? (see page 511)	<less_than_time> ::= 15 ns to 10 seconds in NR3 format <greater_than_time> ::= 10 ns to 9.99 seconds in NR3 format [suffix] ::= {s ms us ns ps}
:TRIGger:GLITch:SOURce <source> (see page 512)	:TRIGger:GLITch:SOURce? (see page 512)	<source> ::= {CHANnel<n> EXTernal} for DSO models <source> ::= {CHANnel<n> DIGital0,...,DIGital15 } for MSO models <n> ::= 1-2 or 1-4 in NR1 format

Table 29 :TRIGger:IIC Commands Summary

Command	Query	Options and Query Returns
:TRIGger:IIC:PATtern:ADDRESS <value> (see page 514)	:TRIGger:IIC:PATtern:ADDRESS? (see page 514)	<value> ::= integer or <string> <string> ::= "0xnn" n ::= {0,...,9 A,...,F}
:TRIGger:IIC:PATtern:DATA <value> (see page 515)	:TRIGger:IIC:PATtern:DATA? (see page 515)	<value> ::= integer or <string> <string> ::= "0xnn" n ::= {0,...,9 A,...,F}

4 Commands Quick Reference

Table 29 :TRIGger:IIC Commands Summary (continued)

Command	Query	Options and Query Returns
:TRIGger:IIC:PATtern:DATA2 <value> (see page 516)	:TRIGger:IIC:PATtern:DATA2? (see page 516)	<value> ::= integer or <string> <string> ::= "0xnn" n ::= {0,...,9 A,...,F}
:TRIGger:IIC[:SOURce]:CLOCK <source> (see page 517)	:TRIGger:IIC[:SOURce]:CLOCK? (see page 517)	<source> ::= {CHANnel<n> EXTernal} for DSO models <source> ::= {CHANnel<n> DIGital0,...,DIGital15 } for MSO models <n> ::= 1-2 or 1-4 in NR1 format
:TRIGger:IIC[:SOURce]:DATA <source> (see page 518)	:TRIGger:IIC[:SOURce]:DATA? (see page 518)	<source> ::= {CHANnel<n> EXTernal} for DSO models <source> ::= {CHANnel<n> DIGital0,...,DIGital15 } for MSO models <n> ::= 1-2 or 1-4 in NR1 format
:TRIGger:IIC:TRIGger:QUALifier <value> (see page 519)	:TRIGger:IIC:TRIGger:QUALifier? (see page 519)	<value> ::= {EQUal NOTequal LESSthan GREATERthan}
:TRIGger:IIC:TRIGger[:TYPE] <type> (see page 520)	:TRIGger:IIC:TRIGger[:TYPE]? (see page 520)	<type> ::= {START STOP READ7 READeprom WRITe7 WRITe10 NACKnowledge ANACKnowledge R7Data2 W7Data2 REStart}

Table 30 :TRIGger:LIN Commands Summary

Command	Query	Options and Query Returns
:TRIGger:LIN:ID <value> (see page 523)	:TRIGger:LIN:ID? (see page 523)	<value> ::= 7-bit integer in decimal, <nondecimal>, or <string> from 0-63 or 0x00-0x3f (with Option AMS) <nondecimal> ::= #Hnn where n ::= {0,...,9 A,...,F} for hexadecimal <nondecimal> ::= #Bnn...n where n ::= {0 1} for binary <string> ::= "0xnn" where n ::= {0,...,9 A,...,F} for hexadecimal
:TRIGger:LIN:SAMplepo int <value> (see page 524)	:TRIGger:LIN:SAMplepo int? (see page 524)	<value> ::= {60 62.5 68 70 75 80 87.5} in NR3 format
:TRIGger:LIN:SIGNAL:BAUDrate <baudrate> (see page 525)	:TRIGger:LIN:SIGNAL:BAUDrate? (see page 525)	<baudrate> ::= integer from 2400 to 625000 in 100 b/s increments

Table 30 :TRIGger:LIN Commands Summary (continued)

Command	Query	Options and Query Returns
:TRIGger:LIN:SOURce <source> (see page 526)	:TRIGger:LIN:SOURce? (see page 526)	<source> ::= {CHANnel<n> EXTErnal} for DSO models <source> ::= {CHANnel<n> DIGital0,...,DIGital15} for MSO models <n> ::= 1-2 or 1-4 in NR1 format
:TRIGger:LIN:STANdard <std> (see page 527)	:TRIGger:LIN:STANdard? (see page 527)	<std> ::= {LIN13 LIN20}
:TRIGger:LIN:SYNCbrea k <value> (see page 528)	:TRIGger:LIN:SYNCbrea k? (see page 528)	<value> ::= integer = {11 12 13}
:TRIGger:LIN:TRIGger <condition> (see page 529)	:TRIGger:LIN:TRIGger? (see page 529)	<condition> ::= {SYNCbreak} (without Option AMS) <condition> ::= {SYNCbreak ID} (with Option AMS)

Table 31 :TRIGger:SEQuence Commands Summary

Command	Query	Options and Query Returns
:TRIGger:SEQuence:COU Nt <count> (see page 531)	:TRIGger:SEQuence:COU Nt? (see page 531)	<count> ::= integer in NR1 format
:TRIGger:SEQuence:EDG E{1 2} <source>, <slope> (see page 532)	:TRIGger:SEQuence:EDG E{1 2}? (see page 532)	<source> ::= {CHANnel<n> EXTErnal} for the DSO models <source> ::= {CHANnel<n> DIGital0,...,DIGital15} for the MSO models <slope> ::= {POSitive NEGative} <n> ::= 1-2 or 1-4 in NR1 format <return_value> ::= query returns "NONE" if edge source is disabled
:TRIGger:SEQuence:FIN D <value> (see page 533)	:TRIGger:SEQuence:FIN D? (see page 533)	<value> ::= {PATTErn1,ENTereD PATTErn1,EXITed EDGE1 PATTErn1,AND,EDGE1}
:TRIGger:SEQuence:PAT Tern{1 2} <value>, <mask> (see page 534)	:TRIGger:SEQuence:PAT Tern{1 2}? (see page 534)	<value> ::= integer or <string> <mask> ::= integer or <string> <string> ::= "0xnxxxxn" n ::= {0,...,9 A,...,F}

4 Commands Quick Reference

Table 31 :TRIGger:SEquence Commands Summary (continued)

Command	Query	Options and Query Returns
:TRIGger:SEquence:RES et <value> (see page 535)	:TRIGger:SEquence:RES et? (see page 535)	<value> ::= {NONE PATtern1,ENTERed PATtern1,EXITed EDGE1 PATtern1,AND,EDGE1 PATtern2,ENTERed PATtern2,EXITed EDGE2 TIMER} Values used in find and trigger stages not available. EDGE2 not available if EDGE2,COUNT used in trigger stage.
:TRIGger:SEquence:TIMER <time_value> (see page 536)	:TRIGger:SEquence:TIMER? (see page 536)	<time_value> ::= time from 10 ns to 10 seconds in NR3 format
:TRIGger:SEquence:TRIGger <value> (see page 537)	:TRIGger:SEquence:TRIGger? (see page 537)	<value> ::= {PATtern2,ENTERed PATtern2,EXITed EDGE2 PATtern2,AND,EDGE2 EDGE2,COUNT EDGE2,COUNT,NREFind}

Table 32 :TRIGger:SPI Commands Summary

Command	Query	Options and Query Returns
:TRIGger:SPI:CLOCK:SLOPe <slope> (see page 539)	:TRIGger:SPI:CLOCK:SLOPe? (see page 539)	<slope> ::= {NEGative POSitive}
:TRIGger:SPI:CLOCK:TIMEout <time_value> (see page 540)	:TRIGger:SPI:CLOCK:TIMEout? (see page 540)	<time_value> ::= time in seconds in NR1 format
:TRIGger:SPI:FRAMing <value> (see page 541)	:TRIGger:SPI:FRAMing? (see page 541)	<value> ::= {CHIPselect NOTChipselect TIMEout}
:TRIGger:SPI:PATtern:DATA <value>, <mask> (see page 542)	:TRIGger:SPI:PATtern:DATA? (see page 542)	<value> ::= integer or <string> <mask> ::= integer or <string> <string> ::= "0xnxxxxx" where n ::= {0,...,9 A,...,F}
:TRIGger:SPI:PATtern:WIDTH <width> (see page 543)	:TRIGger:SPI:PATtern:WIDTH? (see page 543)	<width> ::= integer from 4 to 32 in NR1 format

Table 32 :TRIGger:SPI Commands Summary (continued)

Command	Query	Options and Query Returns
:TRIGger:SPI:SOURce:CLOCK <source> (see page 544)	:TRIGger:SPI:SOURce:CLOCK? (see page 544)	<value> ::= {CHANnel<n> EXTernal} for the DSO models <value> ::= {CHANnel<n> DIGital0,...,DIGital15} for the MSO models <n> ::= 1-2 or 1-4 in NR1 format
:TRIGger:SPI:SOURce:DATA <source> (see page 545)	:TRIGger:SPI:SOURce:DATA? (see page 545)	<value> ::= {CHANnel<n> EXTernal} for the DSO models <value> ::= {CHANnel<n> DIGital0,...,DIGital15} for the MSO models <n> ::= 1-2 or 1-4 in NR1 format
:TRIGger:SPI:SOURce:FRAME <source> (see page 546)	:TRIGger:SPI:SOURce:FRAME? (see page 546)	<value> ::= {CHANnel<n> EXTernal} for the DSO models <value> ::= {CHANnel<n> DIGital0,...,DIGital15} for the MSO models <n> ::= 1-2 or 1-4 in NR1 format

Table 33 :TRIGger:TV Commands Summary

Command	Query	Options and Query Returns
:TRIGger:TV:LINE <line number> (see page 548)	:TRIGger:TV:LINE? (see page 548)	<line number> ::= integer in NR1 format
:TRIGger:TV:MODE <tv mode> (see page 549)	:TRIGger:TV:MODE? (see page 549)	<tv mode> ::= {FIEld1 FIEld2 AFIElds ALINes LINE VERTical LFIeld1 LFIeld2 LALternate LVERTical}
:TRIGger:TV:POLarity <polarity> (see page 550)	:TRIGger:TV:POLarity? (see page 550)	<polarity> ::= {POSitive NEGative}
:TRIGger:TV:SOURce <source> (see page 551)	:TRIGger:TV:SOURce? (see page 551)	<source> ::= {CHANnel<n>} <n> ::= 1-2 or 1-4 integer in NR1 format
:TRIGger:TV:STANdard <standard> (see page 552)	:TRIGger:TV:STANdard? (see page 552)	<standard> ::= {GENeric NTSC PALM PAL SECam {P480L60HZ P480} {P720L60HZ P720} {P1080L24HZ P1080} P1080L25HZ {I1080L50HZ I1080} I1080L60HZ}

Table 34 :TRIGger:UART Commands Summary

Command	Query	Options and Query Returns
:TRIGger:UART:BASE <base> (see page 555)	:TRIGger:UART:BASE? (see page 555)	<base> ::= {ASCIi HEX}
:TRIGger:UART:BAUDrate <baudrate> (see page 556)	:TRIGger:UART:BAUDrate? (see page 556)	<baudrate> ::= integer from 1200 to 3000000 in 100 b/s increments
:TRIGger:UART:BITorder <bitorder> (see page 557)	:TRIGger:UART:BITorder? (see page 557)	<bitorder> ::= {LSBFirst MSBFirst}
:TRIGger:UART:BURSt <value> (see page 558)	:TRIGger:UART:BURSt? (see page 558)	<value> ::= {OFF 1 to 4096 in NR1 format}
:TRIGger:UART:DATA <value> (see page 559)	:TRIGger:UART:DATA? (see page 559)	<value> ::= 8-bit integer from 0-255 (0x00-0xff) in decimal, <hexadecimal>, <binary>, or <quoted_string> format <hexadecimal> ::= #Hnn where n ::= {0,...,9 A,...,F} for hexadecimal <binary> ::= #Bnn...n where n ::= {0 1} for binary <quoted_string> ::= any of the 128 valid 7-bit ASCII characters (or standard abbreviations)
:TRIGger:UART:IDLE <time_value> (see page 560)	:TRIGger:UART:IDLE? (see page 560)	<time_value> ::= time from 1 us to 10 s in NR3 format
:TRIGger:UART:PARity <parity> (see page 561)	:TRIGger:UART:PARity? (see page 561)	<parity> ::= {EVEN ODD NONE}
:TRIGger:UART:POLarity <polarity> (see page 562)	:TRIGger:UART:POLarity? (see page 562)	<polarity> ::= {HIGH LOW}
:TRIGger:UART:QUALifier <value> (see page 563)	:TRIGger:UART:QUALifier? (see page 563)	<value> ::= {EQUAL NOTequal GREaterthan LESSthan}
:TRIGger:UART:SOURce: RX <source> (see page 564)	:TRIGger:UART:SOURce: RX? (see page 564)	<source> ::= {CHANnel<n> EXTErnal} for DSO models <source> ::= {CHANnel<n> DIGital0,...,DIGital15} for MSO models <n> ::= 1-2 or 1-4 in NR1 format

Table 34 :TRIGger:UART Commands Summary (continued)

Command	Query	Options and Query Returns
:TRIGger:UART:SOURce:TX <source> (see page 565)	:TRIGger:UART:SOURce:TX? (see page 565)	<source> ::= {CHANnel<n> EXTErnal} for DSO models <source> ::= {CHANnel<n> DIGital0,...,DIGital15} for MSO models <n> ::= 1-2 or 1-4 in NR1 format
:TRIGger:UART:TYPE <value> (see page 566)	:TRIGger:UART:TYPE? (see page 566)	<value> ::= {RSTArt RSTOp RDATa RD1 RD0 RDX PARityerror TSTArt TSTOp TDATa TD1 TD0 TDX}
:TRIGger:UART:WIDTh <width> (see page 567)	:TRIGger:UART:WIDTh? (see page 567)	<width> ::= {5 6 7 8 9}

Table 35 :TRIGger:USB Commands Summary

Command	Query	Options and Query Returns
:TRIGger:USB:SOURce:D MINus <source> (see page 569)	:TRIGger:USB:SOURce:D MINus? (see page 569)	<source> ::= {CHANnel<n> EXTErnal} for the DSO models <source> ::= {CHANnel<n> DIGital0,...,DIGital15} for the MSO models <n> ::= 1-2 or 1-4 in NR1 format
:TRIGger:USB:SOURce:D Plus <source> (see page 570)	:TRIGger:USB:SOURce:D Plus? (see page 570)	<source> ::= {CHANnel<n> EXTErnal} for the DSO models <source> ::= {CHANnel<n> DIGital0,...,DIGital15} for the MSO models <n> ::= 1-2 or 1-4 in NR1 format
:TRIGger:USB:SPEEd <value> (see page 571)	:TRIGger:USB:SPEEd? (see page 571)	<value> ::= {LOW FULL}
:TRIGger:USB:TRIGger <value> (see page 572)	:TRIGger:USB:TRIGger? (see page 572)	<value> ::= {SOP EOP ENTersuspend EXITsuspend RESet}

4 Commands Quick Reference

Table 36 :WAVeform Commands Summary

Command	Query	Options and Query Returns
:WAVeform:BYTeorder <value> (see page 581)	:WAVeform:BYTeorder? (see page 581)	<value> ::= {LSBFirst MSBFirst}
n/a	:WAVeform:COUNT? (see page 582)	<count> ::= an integer from 1 to 65536 in NR1 format
n/a	:WAVeform:DATA? (see page 583)	<binary block length bytes>, <binary data> For example, to transmit 1000 bytes of data, the syntax would be: #800001000<1000 bytes of data><NL> 8 is the number of digits that follow 00001000 is the number of bytes to be transmitted <1000 bytes of data> is the actual data
:WAVeform:FORMat <value> (see page 585)	:WAVeform:FORMat? (see page 585)	<value> ::= {WORD BYTE ASCII}
:WAVeform:POINTs <# points> (see page 586)	:WAVeform:POINTs? (see page 586)	<# points> ::= {100 250 500 1000 <points_mode>} if waveform points mode is NORMAl <# points> ::= {100 250 500 1000 2000 ... 8000000 in 1-2-5 sequence <points_mode>} if waveform points mode is MAXimum or RAW <points_mode> ::= {NORMAl MAXimum RAW}
:WAVeform:POINTs:MODE <points_mode> (see page 588)	:WAVeform:POINTs:MODE ? (see page 589)	<points_mode> ::= {NORMAl MAXimum RAW}

Table 36 :WAVEform Commands Summary (continued)

Command	Query	Options and Query Returns
n/a	:WAVEform:PREamble? (see page 590)	<p><preamble_block> ::= <format NR1>, <type NR1>,<points NR1>,<count NR1>, <xincrement NR3>, <xorigin NR3>, <xreference NR1>,<yincrement NR3>, <yorigin NR3>, <yreference NR1></p> <p><format> ::= an integer in NR1 format:</p> <ul style="list-style-type: none"> • 0 for BYTE format • 1 for WORD format • 2 for ASCII format <p><type> ::= an integer in NR1 format:</p> <ul style="list-style-type: none"> • 0 for NORMAL type • 1 for PEAK detect type • 2 for AVERAGE type • 3 for HRESolution type <p><count> ::= Average count, or 1 if PEAK detect type or NORMAL; an integer in NR1 format</p>
n/a	:WAVEform:SEGmented:COUNT? (see page 593)	<count> ::= an integer from 2 to 2000 in NR1 format (with Option SGM)
n/a	:WAVEform:SEGmented:TAG? (see page 594)	<time_tag> ::= in NR3 format (with Option SGM)
:WAVEform:SOURce <source> (see page 595)	:WAVEform:SOURce? (see page 595)	<p><source> ::= {CHANnel<n> FUNCTION MATH SBUS} for DSO models</p> <p><source> ::= {CHANnel<n> POD{1 2} BUS{1 2} FUNCTION MATH SBUS} for MSO models</p> <p><n> ::= 1-2 or 1-4 in NR1 format</p>
:WAVEform:SOURce:SUBSource <subsource> (see page 599)	:WAVEform:SOURce:SUBSource? (see page 599)	<subsource> ::= {NONE RX} TX
n/a	:WAVEform:TYPE? (see page 600)	<return_mode> ::= {NORM PEAK AVER HRES}
:WAVEform:UNSigned {{0 OFF} {1 ON}} (see page 601)	:WAVEform:UNSigned? (see page 601)	{0 1}
:WAVEform:VIEW <view> (see page 602)	:WAVEform:VIEW? (see page 602)	<view> ::= {MAIN}

Table 36 :WAVeform Commands Summary (continued)

Command	Query	Options and Query Returns
n/a	:WAVeform:XINCrement? (see page 603)	<return_value> ::= x-increment in the current preamble in NR3 format
n/a	:WAVeform:XORigin? (see page 604)	<return_value> ::= x-origin value in the current preamble in NR3 format
n/a	:WAVeform:XREFerence? (see page 605)	<return_value> ::= 0 (x-reference value in the current preamble in NR1 format)
n/a	:WAVeform:YINCrement? (see page 606)	<return_value> ::= y-increment value in the current preamble in NR3 format
n/a	:WAVeform:YORigin? (see page 607)	<return_value> ::= y-origin in the current preamble in NR3 format
n/a	:WAVeform:YREFerence? (see page 608)	<return_value> ::= y-reference value in the current preamble in NR1 format

Syntax Elements

- "Number Format" on page 99
- "<NL> (Line Terminator)" on page 99
- "[] (Optional Syntax Terms)" on page 99
- "{ } (Braces)" on page 99
- " ::= (Defined As)" on page 99
- "< > (Angle Brackets)" on page 100
- "... (Ellipsis)" on page 100
- "n,...,p (Value Ranges)" on page 100
- "d (Digits)" on page 100
- "Quoted ASCII String" on page 100
- "Definite-Length Block Response Data" on page 100

Number Format

NR1 specifies integer data.

NR3 specifies exponential data in floating point format (for example, -1.0E-3).

<NL> (Line Terminator)

<NL> = new line or linefeed (ASCII decimal 10).

The line terminator, or a leading colon, will send the parser to the "root" of the command tree.

[] (Optional Syntax Terms)

Items enclosed in square brackets, [], are optional.

{ } (Braces)

When several items are enclosed by braces, { }, only one of these elements may be selected. Vertical line (|) indicates "or". For example, {ON | OFF} indicates that only ON or OFF may be selected, not both.

::= (Defined As)

::= means "defined as".

For example, `<A> ::= ` indicates that `<A>` can be replaced by `` in any statement containing `<A>`.

< > (Angle Brackets)

`< >` Angle brackets enclose words or characters that symbolize a program code parameter or an interface command.

... (Ellipsis)

... An ellipsis (trailing dots) indicates that the preceding element may be repeated one or more times.

n,...,p (Value Ranges)

`n,...,p ::=` all integers between `n` and `p` inclusive.

d (Digits)

`d ::=` A single ASCII numeric character 0 - 9.

Quoted ASCII String

A quoted ASCII string is a string delimited by either double quotes (`"`) or single quotes (`'`). Some command parameters require a quoted ASCII string. For example, when using the Agilent VISA COM library in Visual Basic, the command:

```
myScope.WriteString ":CHANNEL1:LABEL 'One'"
```

has a quoted ASCII string of:

```
'One'
```

In order to read quoted ASCII strings from query return values, some programming languages require special handling or syntax.

Definite-Length Block Response Data

Definite-length block response data allows any type of device-dependent data to be transmitted over the system interface as a series of 8-bit binary data bytes. This is particularly useful for sending large quantities of data or 8-bit extended ASCII codes. This syntax is a pound sign (`#`) followed by a non-zero digit representing the number of digits in the decimal integer. After the non-zero digit is the decimal integer that states the number of 8-bit data bytes being sent. This is followed by the actual data.

For example, for transmitting 1000 bytes of data, the syntax would be

```
#800001000<1000 bytes of data> <NL>
```

8 is the number of digits that follow

00001000 is the number of bytes to be transmitted

<1000 bytes of data> is the actual data

4 Commands Quick Reference

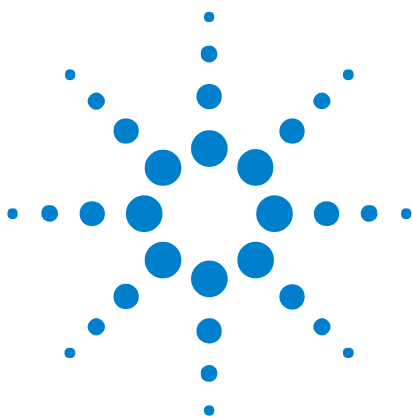

5 Commands by Subsystem

Subsystem	Description
"Common (*) Commands" on page 105	Commands defined by IEEE 488.2 standard that are common to all instruments.
"Root (:) Commands" on page 131	Control many of the basic functions of the oscilloscope and reside at the root level of the command tree.
":ACQuire Commands" on page 173	Set the parameters for acquiring and storing data.
":BUS<n> Commands" on page 190	Control all oscilloscope functions associated with the digital channels bus display.
":CALibrate Commands" on page 199	Utility commands for determining the state of the calibration factor protection switch.
":CHANnel<n> Commands" on page 209	Control all oscilloscope functions associated with individual analog channels or groups of channels.
":DIGital<n> Commands" on page 228	Control all oscilloscope functions associated with individual digital channels.
":DISPlay Commands" on page 235	Control how waveforms, graticule, and text are displayed and written on the screen.
":EXTernal Trigger Commands" on page 245	Control the input characteristics of the external trigger input.
":FUNction Commands" on page 255	Control functions in the measurement/storage module.
":HARDcopy Commands" on page 272	Set and query the selection of hardcopy device and formatting options.
":MARKer Commands" on page 283	Set and query the settings of X-axis markers (X1 and X2 cursors) and the Y-axis markers (Y1 and Y2 cursors).
":MEASure Commands" on page 294	Select automatic measurements to be made and control time markers.



5 Commands by Subsystem

Subsystem	Description
":MTESt Commands" on page 346	Control the mask test features provided with Option LMT.
":POD Commands" on page 379	Control all oscilloscope functions associated with groups of digital channels.
":RECall Commands" on page 384	Recall previously saved oscilloscope setups and traces.
":SAVE Commands" on page 390	Save oscilloscope setups and traces, screen images, and data.
":SBUS Commands" on page 406	Control oscilloscope functions associated with the serial decode bus.
":SYSTem Commands" on page 433	Control basic system functions of the oscilloscope.
":TIMebase Commands" on page 442	Control all horizontal sweep functions.
":TRIGger Commands" on page 454	Control the trigger modes and parameters for each trigger type.
":WAVEform Commands" on page 573	Provide access to waveform data.

Command Types Three types of commands are used:

- **Common (*) Commands** – See ["Introduction to Common \(*\) Commands"](#) on page 107 for more information.
- **Root Level (:) Commands** – See ["Introduction to Root \(: \) Commands"](#) on page 133 for more information.
- **Subsystem Commands** – Subsystem commands are grouped together under a common node of the ["Command Tree"](#) on page 745, such as the :TIMebase commands. Only one subsystem may be selected at any given time. When the instrument is initially turned on, the command parser is set to the root of the command tree; therefore, no subsystem is selected.

Common (*) Commands

Commands defined by IEEE 488.2 standard that are common to all instruments. See "Introduction to Common (*) Commands" on page 107.

Table 37 Common (*) Commands Summary

Command	Query	Options and Query Returns
*CLS (see page 109)	n/a	n/a
*ESE <mask> (see page 110)	*ESE? (see page 111)	<p><mask> ::= 0 to 255; an integer in NR1 format:</p> <pre> Bit Weight Name Enables ----- 7 128 PON Power On 6 64 URQ User Request 5 32 CME Command Error 4 16 EXE Execution Error 3 8 DDE Dev. Dependent Error 2 4 QYE Query Error 1 2 RQL Request Control 0 1 OPC Operation Complete </pre>
n/a	*ESR? (see page 112)	<status> ::= 0 to 255; an integer in NR1 format
n/a	*IDN? (see page 112)	<p>AGILENT TECHNOLOGIES,<model>,<serial number>,X.XX.XX</p> <p><model> ::= the model number of the instrument</p> <p><serial number> ::= the serial number of the instrument</p> <p><X.XX.XX> ::= the software revision of the instrument</p>
n/a	*LRN? (see page 115)	<learn_string> ::= current instrument setup as a block of data in IEEE 488.2 # format
*OPC (see page 116)	*OPC? (see page 116)	ASCII "1" is placed in the output queue when all pending device operations have completed.

Table 37 Common (*) Commands Summary (continued)

Command	Query	Options and Query Returns
n/a	*OPT? (see page 117)	<pre> <return_value> ::= 0,0,<license info> <license info> ::= <All field>, <reserved>, <Factory MSO>, <Upgraded MSO>, <Xilinx FPGA Probe>, <Memory>, <Low Speed Serial>, <Automotive Serial>, <reserved>, <Secure>, <Battery>, <Altera FPGA Probe>, <FlexRay Serial>, <reserved>, <RS-232/UART Serial>, <reserved> <All field> ::= {0 All} <reserved> ::= 0 <Factory MSO> ::= {0 MSO} <Upgraded MSO> ::= {0 MSO} <Xilinx FPGA Probe> ::= {0 FPG} <Memory> ::= {0 mem2M mem8M} <Low Speed Serial> ::= {0 LSS} <Automotive Serial> ::= {0 AMS} <Secure> ::= {0 SEC} <Battery> ::= {0 BAT} <Altera FPGA Probe> ::= {0 ALT} <FlexRay Serial> ::= {0 FRS} <RS-232/UART Serial> ::= {0 232} </pre>
*RCL <value> (see page 119)	n/a	<pre> <value> ::= {0 1 2 3 4 5 6 7 8 9} </pre>
*RST (see page 120)	n/a	See *RST (Reset) (see page 120)
*SAV <value> (see page 123)	n/a	<pre> <value> ::= {0 1 2 3 4 5 6 7 8 9} </pre>
*SRE <mask> (see page 124)	*SRE? (see page 125)	<pre> <mask> ::= sum of all bits that are set, 0 to 255; an integer in NR1 format. <mask> ::= following values: Bit Weight Name Enables ----- 7 128 OPER Operation Status Reg 6 64 ---- (Not used.) 5 32 ESB Event Status Bit 4 16 MAV Message Available 3 8 ---- (Not used.) 2 4 MSG Message 1 2 USR User 0 1 TRG Trigger </pre>

Table 37 Common (*) Commands Summary (continued)

Command	Query	Options and Query Returns
n/a	*STB? (see page 126)	<p><value> ::= 0 to 255; an integer in NR1 format, as shown in the following:</p> <pre> Bit Weight Name "1" Indicates ----- 7 128 OPER Operation status condition occurred. 6 64 RQS/ Instrument is MSS requesting service. 5 32 ESB Enabled event status condition occurred. 4 16 MAV Message available. 3 8 ---- (Not used.) 2 4 MSG Message displayed. 1 2 USR User event condition occurred. 0 1 TRG A trigger occurred. </pre>
*TRG (see page 128)	n/a	n/a
n/a	*TST? (see page 129)	<result> ::= 0 or non-zero value; an integer in NR1 format
*WAI (see page 130)	n/a	n/a

Introduction to Common (*) Commands

The common commands are defined by the IEEE 488.2 standard. They are implemented by all instruments that comply with the IEEE 488.2 standard. They provide some of the basic instrument functions, such as instrument identification and reset, reading the instrument setup, and determining how status is read and cleared.

Common commands can be received and processed by the instrument whether they are sent over the interface as separate program messages or within other program messages. If an instrument subsystem has been selected and a common command is received by the instrument, the instrument remains in the selected subsystem. For example, if the program message ":ACquire:TYPE AVERage; *CLS; COUNT 256" is received by the instrument, the instrument sets the acquire type, then clears the status information and sets the average count.

In contrast, if a root level command or some other subsystem command is within the program message, you must re-enter the original subsystem after the command. For example, the program message ":ACquire:TYPE AVERage; :AUToscale; :ACquire:COUNT 256" sets the acquire type, completes the autoscale, then sets the acquire count. In this example, :ACquire must be sent again after the :AUToscale command in order to re-enter the ACquire subsystem and set the count.

5 Commands by Subsystem

NOTE

Each of the status registers has an enable (mask) register. By setting the bits in the enable register, you can select the status information you want to use.

*CLS (Clear Status)

C (see [page 740](#))

Command Syntax

*CLS

The *CLS common command clears the status data structures, the device-defined error queue, and the Request-for-OPC flag.

NOTE

If the *CLS command immediately follows a program message terminator, the output queue and the MAV (message available) bit are cleared.

- See Also**
- ["Introduction to Common \(*\) Commands"](#) on page 107
 - ["*STB \(Read Status Byte\)"](#) on page 126
 - ["*ESE \(Standard Event Status Enable\)"](#) on page 110
 - ["*ESR \(Standard Event Status Register\)"](#) on page 112
 - ["*SRE \(Service Request Enable\)"](#) on page 124
 - [":SYSTem:ERRor"](#) on page 436

*ESE (Standard Event Status Enable)

C (see page 740)

Command Syntax *ESE <mask_argument>

<mask_argument> ::= integer from 0 to 255

The *ESE common command sets the bits in the Standard Event Status Enable Register. The Standard Event Status Enable Register contains a mask value for the bits to be enabled in the Standard Event Status Register. A "1" in the Standard Event Status Enable Register enables the corresponding bit in the Standard Event Status Register. A zero disables the bit.

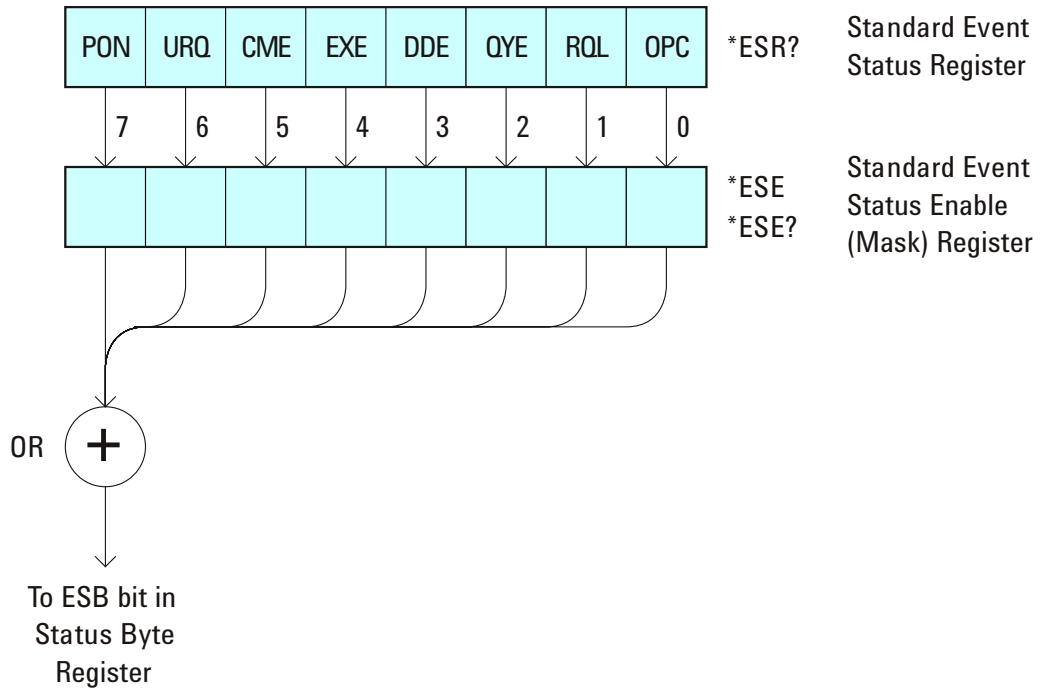

Table 38 Standard Event Status Enable (ESE)

Bit	Name	Description	When Set (1 = High = True), Enables:
7	PON	Power On	Event when an OFF to ON transition occurs.
6	URQ	User Request	Event when a front-panel key is pressed.
5	CME	Command Error	Event when a command error is detected.
4	EXE	Execution Error	Event when an execution error is detected.
3	DDE	Device Dependent Error	Event when a device-dependent error is detected.
2	QYE	Query Error	Event when a query error is detected.

Table 38 Standard Event Status Enable (ESE) (continued)

Bit	Name	Description	When Set (1 = High = True), Enables:
1	RQL	Request Control	Event when the device is requesting control. (Not used.)
0	OPC	Operation Complete	Event when an operation is complete.

Query Syntax *ESE?

The *ESE? query returns the current contents of the Standard Event Status Enable Register.

Return Format <mask_argument><NL>

<mask_argument> ::= 0,...,255; an integer in NR1 format.

- See Also**
- ["Introduction to Common \(*\) Commands"](#) on page 107
 - ["*ESR \(Standard Event Status Register\)"](#) on page 112
 - ["*OPC \(Operation Complete\)"](#) on page 116
 - ["*CLS \(Clear Status\)"](#) on page 109

*ESR (Standard Event Status Register)

C (see page 740)

Query Syntax *ESR?

The *ESR? query returns the contents of the Standard Event Status Register. When you read the Event Status Register, the value returned is the total bit weights of all of the bits that are high at the time you read the byte. Reading the register clears the Event Status Register.

The following table shows bit weight, name, and condition for each bit.

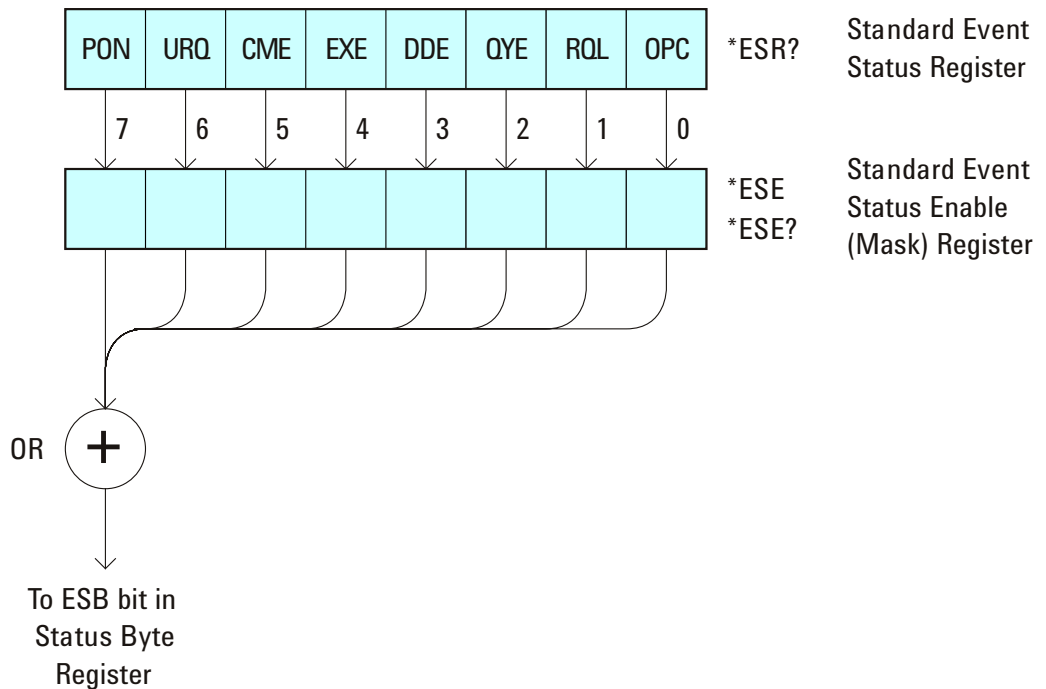

Table 39 Standard Event Status Register (ESR)

Bit	Name	Description	When Set (1 = High = True), Indicates:
7	PON	Power On	An OFF to ON transition has occurred.
6	URQ	User Request	A front-panel key has been pressed.
5	CME	Command Error	A command error has been detected.
4	EXE	Execution Error	An execution error has been detected.
3	DDE	Device Dependent Error	A device-dependent error has been detected.
2	QYE	Query Error	A query error has been detected.

Table 39 Standard Event Status Register (ESR) (continued)

Bit	Name	Description	When Set (1 = High = True), Indicates:
1	RQL	Request Control	The device is requesting control. (Not used.)
0	OPC	Operation Complete	Operation is complete.

Return Format <status><NL>
 <status> ::= 0,..,255; an integer in NR1 format.

NOTE

Reading the Standard Event Status Register clears it. High or 1 indicates the bit is true.

- See Also**
- ["Introduction to Common \(*\) Commands"](#) on page 107
 - ["*ESE \(Standard Event Status Enable\)"](#) on page 110
 - ["*OPC \(Operation Complete\)"](#) on page 116
 - ["*CLS \(Clear Status\)"](#) on page 109
 - [":SYSTem:ERRor"](#) on page 436

*IDN (Identification Number)

C (see [page 740](#))

Query Syntax *IDN?

The *IDN? query identifies the instrument type and software version.

Return Format AGILENT TECHNOLOGIES,<model>,<serial number>,X.XX.XX <NL>

<model> ::= the model number of the instrument

<serial number> ::= the serial number of the instrument

X.XX.XX ::= the software revision of the instrument

- See Also**
- ["Introduction to Common \(*\) Commands"](#) on page 107
 - ["*OPT \(Option Identification\)"](#) on page 117

*LRN (Learn Device Setup)

C (see [page 740](#))

Query Syntax

*LRN?

The *LRN? query result contains the current state of the instrument. This query is similar to the :SYSTEM:SETup? (see [page 439](#)) query, except that it contains ":SYST:SET " before the binary block data. The query result is a valid command that can be used to restore instrument settings at a later time.

Return Format

<learn_string><NL>

<learn_string> ::= :SYST:SET <setup_data>

<setup_data> ::= binary block data in IEEE 488.2 # format

<learn string> specifies the current instrument setup. The block size is subject to change with different firmware revisions.

NOTE

The *LRN? query return format has changed from previous Agilent oscilloscopes to match the IEEE 488.2 specification which says that the query result must contain ":SYST:SET " before the binary block data.

See Also

- "[Introduction to Common \(*\) Commands](#)" on page 107
- "[*RCL \(Recall\)](#)" on page 119
- "[*SAV \(Save\)](#)" on page 123
- "[:SYSTEM:SETup](#)" on page 439

*OPC (Operation Complete)

C (see [page 740](#))

Command Syntax *OPC

The *OPC command sets the operation complete bit in the Standard Event Status Register when all pending device operations have finished.

Query Syntax *OPC?

The *OPC? query places an ASCII "1" in the output queue when all pending device operations have completed. The interface hangs until this query returns.

Return Format <complete><NL>

<complete> ::= 1

- See Also**
- ["Introduction to Common \(*\) Commands"](#) on page 107
 - ["*ESE \(Standard Event Status Enable\)"](#) on page 110
 - ["*ESR \(Standard Event Status Register\)"](#) on page 112
 - ["*CLS \(Clear Status\)"](#) on page 109

*OPT (Option Identification)

C (see page 740)

Query Syntax *OPT?

The *OPT? query reports the options installed in the instrument. This query returns a string that identifies the module and its software revision level.

Return Format 0,0,<license info>

```
<license info> ::= <All field>,<reserved>,<Factory MSO>,<Upgraded MSO>,<Xilinx FPGA Probe>,<Memory>,<Low Speed Serial>,<Automotive Serial>,<reserved>,<Secure>,<Battery>,<Altera FPGA Probe>,<FlexRay Serial>,<reserved>,<RS-232/UART Serial>,<reserved>,<Segmented Memory>,<Mask Test>,<reserved>
```

```
<All field> ::= {0 | All}
```

```
<reserved> ::= 0
```

```
<Factory MSO> ::= {0 | MSO}
```

```
<Upgraded MSO> ::= {0 | MSO}
```

```
<Xilinx FPGA Probe> ::= {0 | FPG}
```

```
<Memory> ::= {0 | mem2M | mem8M}
```

```
<Low Speed Serial> ::= {0 | LSS}
```

```
<Automotive Serial> ::= {0 | AMS}
```

```
<Secure> ::= {0 | SEC}
```

```
<Battery> ::= {0 | BAT}
```

```
<Altera FPGA Probe> ::= {0 | ALT}
```

```
<FlexRay Serial> ::= {0 | FRS}
```

```
<RS-232/UART Serial> ::= {0 | 232}
```

```
<Segmented Memory> ::= {0 | SGM}
```

```
<Mask Test> ::= {0 | LMT}
```

The <Factory MSO> <Upgraded MSO> fields indicate whether the unit is a mixed-signal oscilloscope and, if so, whether it was factory installed or upgraded from an analog channels only oscilloscope (DSO).

The *OPT? query returns the following:

Module	Module Id
No modules attached	0,0,0,0,MSO,0,0,mem8M,0,0,0,0,0,0,0,0,0,0,0,0,0,0

5 Commands by Subsystem

- See Also**
- "Introduction to Common (*) Commands" on page 107
 - "*IDN (Identification Number)" on page 114

*RCL (Recall)

C (see [page 740](#))

Command Syntax *RCL <value>

<value> ::= {0 | 1 | 2 | 3 | 4 | 5 | 6 | 7 | 8 | 9}

The *RCL command restores the state of the instrument from the specified save/recall register.

- See Also**
- ["Introduction to Common \(*\) Commands"](#) on page 107
 - ["*SAV \(Save\)"](#) on page 123

***RST (Reset)**

C (see [page 740](#))

Command Syntax *RST

The *RST command places the instrument in a known state. Reset conditions are:

Acquire Menu	
Mode	Normal
Realtime	On
Averaging	Off
# Averages	8

Analog Channel Menu	
Channel 1	On
Channel 2	Off
Volts/division	5.00 V
Offset	0.00
Coupling	DC
Probe attenuation	AutoProbe (if AutoProbe is connected), otherwise 1.0:1
Vernier	Off
Invert	Off
BW limit	Off
Impedance	1 M Ohm
Units	Volts
Skew	0

Cursor Menu	
Source	Channel 1

Digital Channel Menu (MSO models only)	
Channel 0 - 15	Off
Labels	Off
Threshold	TTL (1.4V)

Display Menu	
Definite persistence	Off
Grid	33%
Vectors	On

Quick Meas Menu	
Source	Channel 1

Run Control	
	Scope is running

Time Base Menu	
Main time/division	100 us
Main time base delay	0.00 s
Delay time/division	500 ns
Delay time base delay	0.00 s
Reference	center
Mode	main
Vernier	Off

Trigger Menu	
Type	Edge
Mode	Auto
Coupling	dc
Source	Channel 1
Level	0.0 V

5 Commands by Subsystem

Trigger Menu	
Slope	Positive
HF Reject and noise reject	Off
Holdoff	60 ns
External probe attenuation	AutoProbe (if AutoProbe is connected), otherwise 1.0:1
External Units	Volts
External Impedance	1 M Ohm

See Also • ["Introduction to Common \(*\) Commands"](#) on page 107

Example Code

```
' RESET - This command puts the oscilloscope into a known state.  
' This statement is very important for programs to work as expected.  
' Most of the following initialization commands are initialized by  
' *RST. It is not necessary to reinitialize them unless the default  
' setting is not suitable for your application.  
myScope.WriteString "*RST" ' Reset the oscilloscope to the defaults.
```

Example program from the start: ["VISA COM Example in Visual Basic"](#) on page 828

*SAV (Save)

C (see [page 740](#))

Command Syntax *SAV <value>

<value> ::= {0 | 1 | 2 | 3 | 4 | 5 | 6 | 7 | 8 | 9}

The *SAV command stores the current state of the instrument in a save register. The data parameter specifies the register where the data will be saved.

- See Also**
- ["Introduction to Common \(*\) Commands"](#) on page 107
 - ["*RCL \(Recall\)"](#) on page 119

*SRE (Service Request Enable)

C (see page 740)

Command Syntax *SRE <mask>

<mask> ::= integer with values defined in the following table.

The *SRE command sets the bits in the Service Request Enable Register. The Service Request Enable Register contains a mask value for the bits to be enabled in the Status Byte Register. A one in the Service Request Enable Register enables the corresponding bit in the Status Byte Register. A zero disables the bit.

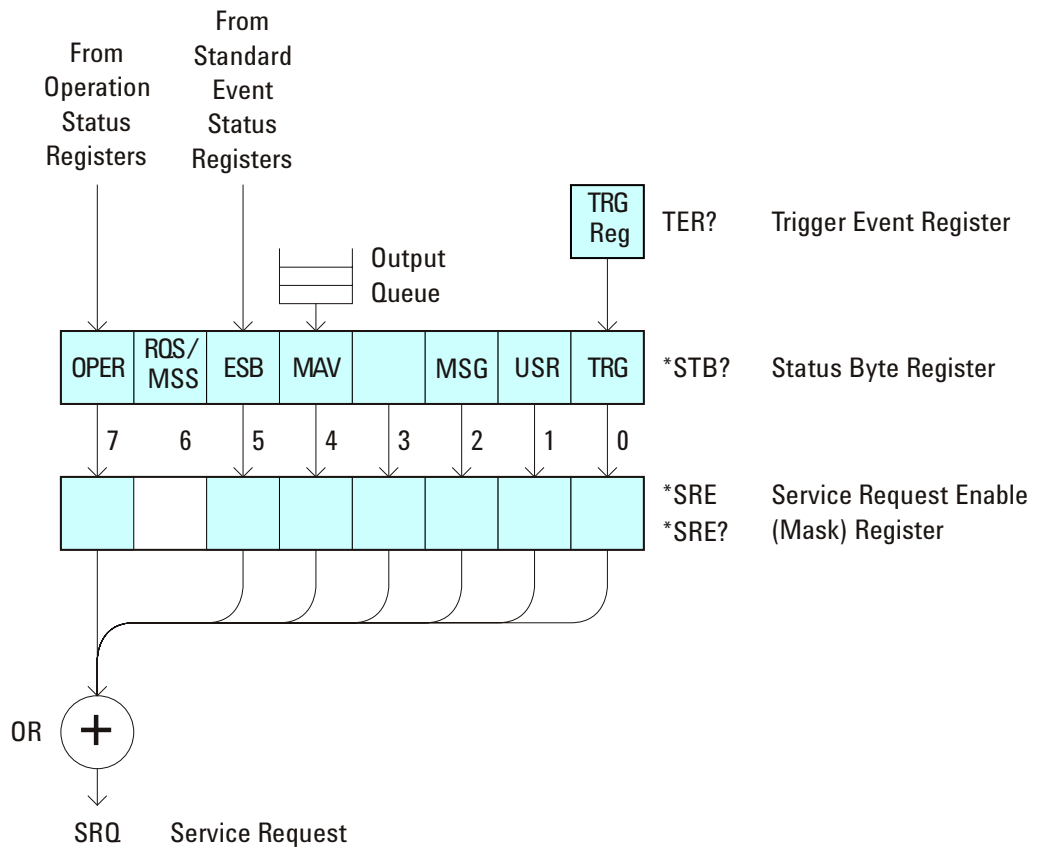

Table 40 Service Request Enable Register (SRE)

Bit	Name	Description	When Set (1 = High = True), Enables:
7	OPER	Operation Status Register	Interrupts when enabled conditions in the Operation Status Register (OPER) occur.
6	---	---	(Not used.)

Table 40 Service Request Enable Register (SRE) (continued)

Bit	Name	Description	When Set (1 = High = True), Enables:
5	ESB	Event Status Bit	Interrupts when enabled conditions in the Standard Event Status Register (ESR) occur.
4	MAV	Message Available	Interrupts when messages are in the Output Queue.
3	---	---	(Not used.)
2	MSG	Message	Interrupts when an advisory has been displayed on the oscilloscope.
1	USR	User Event	Interrupts when enabled user event conditions occur.
0	TRG	Trigger	Interrupts when a trigger occurs.

Query Syntax *SRE?

The *SRE? query returns the current value of the Service Request Enable Register.

Return Format <mask><NL>

<mask> ::= sum of all bits that are set, 0,...,255;
an integer in NR1 format

- See Also**
- ["Introduction to Common \(*\) Commands"](#) on page 107
 - ["*STB \(Read Status Byte\)"](#) on page 126
 - ["*CLS \(Clear Status\)"](#) on page 109

*STB (Read Status Byte)

C (see page 740)

Query Syntax *STB?

The *STB? query returns the current value of the instrument's status byte. The MSS (Master Summary Status) bit is reported on bit 6 instead of the RQS (request service) bit. The MSS indicates whether or not the device has at least one reason for requesting service.

Return Format <value><NL>
 <value> ::= 0,...,255; an integer in NR1 format

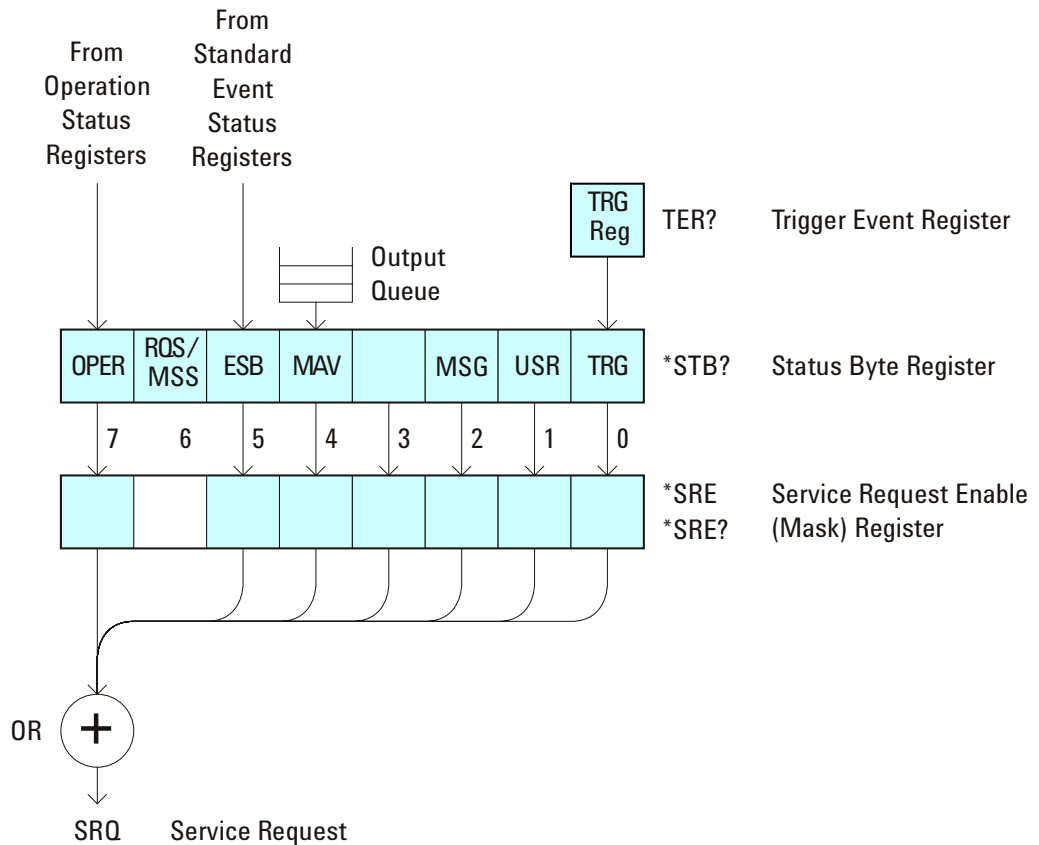

Table 41 Status Byte Register (STB)

Bit	Name	Description	When Set (1 = High = True), Indicates:
7	OPER	Operation Status Register	An enabled condition in the Operation Status Register (OPER) has occurred.

Table 41 Status Byte Register (STB) (continued)

Bit	Name	Description	When Set (1 = High = True), Indicates:
6	RQS	Request Service	When polled, that the device is requesting service.
	MSS	Master Summary Status	When read (by *STB?), whether the device has a reason for requesting service.
5	ESB	Event Status Bit	An enabled condition in the Standard Event Status Register (ESR) has occurred.
4	MAV	Message Available	There are messages in the Output Queue.
3	---	---	(Not used, always 0.)
2	MSG	Message	An advisory has been displayed on the oscilloscope.
1	USR	User Event	An enabled user event condition has occurred.
0	TRG	Trigger	A trigger has occurred.

NOTE

To read the instrument's status byte with RQS reported on bit 6, use the interface Serial Poll.

- See Also**
- ["Introduction to Common \(*\) Commands"](#) on page 107
 - ["*SRE \(Service Request Enable\)"](#) on page 124

*TRG (Trigger)

C (see [page 740](#))

Command Syntax *TRG

The *TRG command has the same effect as the :DIGitize command with no parameters.

- See Also**
- ["Introduction to Common \(*\) Commands"](#) on page 107
 - [":DIGitize"](#) on page 142
 - [":RUN"](#) on page 166
 - [":STOP"](#) on page 170

*TST (Self Test)

C (see [page 740](#))

Query Syntax *TST?

The *TST? query performs a self-test on the instrument. The result of the test is placed in the output queue. A zero indicates the test passed and a non-zero indicates the test failed. If the test fails, refer to the troubleshooting section of the *Service Guide*.

Return Format <result><NL>

<result> ::= 0 or non-zero value; an integer in NR1 format

See Also • ["Introduction to Common \(*\) Commands"](#) on page 107

*WAI (Wait To Continue)

C (see [page 740](#))

Command Syntax *WAI

The *WAI command has no function in the oscilloscope, but is parsed for compatibility with other instruments.

See Also • ["Introduction to Common \(*\) Commands"](#) on page 107

Root (:) Commands

Control many of the basic functions of the oscilloscope and reside at the root level of the command tree. See ["Introduction to Root \(:\) Commands"](#) on page 133.

Table 42 Root (:) Commands Summary

Command	Query	Options and Query Returns
:ACTivity (see page 134)	:ACTivity? (see page 134)	<return value> ::= <edges>,<levels> <edges> ::= presence of edges (32-bit integer in NR1 format) <levels> ::= logical highs or lows (32-bit integer in NR1 format)
n/a	:AER? (see page 135)	{0 1}; an integer in NR1 format
:AUToscale [<source>[,...,<source>]] (see page 136)	n/a	<source> ::= CHANnel<n> for DSO models <source> ::= {CHANnel<n> DIGital0,...,DIGital15 POD1 POD2} for MSO models <source> can be repeated up to 5 times <n> ::= 1-2 or 1-4 in NR1 format
:AUToscale:AMODE <value> (see page 138)	:AUToscale:AMODE? (see page 138)	<value> ::= {NORMAL CURRENT}}
:AUToscale:CHANnels <value> (see page 139)	:AUToscale:CHANnels? (see page 139)	<value> ::= {ALL DISPLAYed}}
:BLANK [<source>] (see page 140)	n/a	<source> ::= {CHANnel<n>} FUNCTION MATH SBUS} for DSO models <source> ::= {CHANnel<n> DIGital0,...,DIGital15 POD{1 2} BUS{1 2} FUNCTION MATH SBUS} for MSO models <n> ::= 1-2 or 1-4 in NR1 format
:CDISplay (see page 141)	n/a	n/a

5 Commands by Subsystem

Table 42 Root (:): Commands Summary (continued)

Command	Query	Options and Query Returns
:DIGitize [<source>[,...,<source>]] (see page 142)	n/a	<source> ::= {CHANnel<n> FUNCTION MATH SBUS} for DSO models <source> ::= {CHANnel<n> DIGital0,...,DIGital15 POD{1 2} BUS{1 2} FUNCTION MATH SBUS} for MSO models <source> can be repeated up to 5 times <n> ::= 1-2 or 1-4 in NR1 format
:HWEenable <n> (see page 144)	:HWEenable? (see page 144)	<n> ::= 16-bit integer in NR1 format
n/a	:HWERegister:CONDition? (see page 146)	<n> ::= 16-bit integer in NR1 format
n/a	:HWERegister[:EVENT]? (see page 148)	<n> ::= 16-bit integer in NR1 format
:MERGE <pixel memory> (see page 150)	n/a	<pixel memory> ::= {PMEemory{0 1 2 3 4 5 6 7 8 9}}
:MTEenable <n> (see page 151)	:MTEenable? (see page 151)	<n> ::= 16-bit integer in NR1 format
n/a	:MTERegister[:EVENT]? (see page 153)	<n> ::= 16-bit integer in NR1 format
:OPEE <n> (see page 155)	:OPEE? (see page 156)	<n> ::= 16-bit integer in NR1 format
n/a	:OPERRegister:CONDition? (see page 157)	<n> ::= 16-bit integer in NR1 format
n/a	:OPERRegister[:EVENT]? (see page 159)	<n> ::= 16-bit integer in NR1 format
:OVLenable <mask> (see page 161)	:OVLenable? (see page 162)	<mask> ::= 16-bit integer in NR1 format as shown: Bit Weight Input ----- 10 1024 Ext Trigger Fault 9 512 Channel 4 Fault 8 256 Channel 3 Fault 7 128 Channel 2 Fault 6 64 Channel 1 Fault 4 16 Ext Trigger OVL 3 8 Channel 4 OVL 2 4 Channel 3 OVL 1 2 Channel 2 OVL 0 1 Channel 1 OVL

Table 42 Root (:) Commands Summary (continued)

Command	Query	Options and Query Returns
n/a	:OVLRegister? (see page 163)	<value> ::= integer in NR1 format. See OVLenable for <value>
:PRINT [<options>] (see page 165)	n/a	<options> ::= [<print option>][,...,<print option>] <print option> ::= {COLor GRAYscale PRINter0 BMP8bit BMP PNG NOFactoRs FACToRs} <print option> can be repeated up to 5 times.
:RUN (see page 166)	n/a	n/a
n/a	:SERial (see page 167)	<return value> ::= unquoted string containing serial number
:SINGle (see page 168)	n/a	n/a
n/a	:STATus? <display> (see page 169)	{0 1} <display> ::= {CHANnel<n> DIGital0,...,DIGital15 POD{1 2} BUS{1 2} FUNctioN MATH SBUS} <n> ::= 1-2 or 1-4 in NR1 format
:STOP (see page 170)	n/a	n/a
n/a	:TER? (see page 171)	{0 1}
:VIEW <source> (see page 172)	n/a	<source> ::= {CHANnel<n> PMEMory{0 1 2 3 4 5 6 7 8 9} FUNctioN MATH SBUS} for DSO models <source> ::= {CHANnel<n> DIGital0,...,DIGital15 PMEMory{0 1 2 3 4 5 6 7 8 9} POD{1 2} BUS{1 2} FUNctioN MATH SBUS} for MSO models <n> ::= 1-2 or 1-4 in NR1 format

Introduction to Root (:) Commands

Root level commands control many of the basic operations of the instrument. These commands are always recognized by the parser if they are prefixed with a colon, regardless of current command tree position. After executing a root-level command, the parser is positioned at the root of the command tree.

:ACTivity

N (see [page 740](#))

Command Syntax :ACTivity

The :ACTivity command clears the cumulative edge variables for the next activity query.

Query Syntax :ACTivity?

The :ACTivity? query returns whether there has been activity (edges) on the digital channels since the last query, and returns the current logic levels.

NOTE

Because the :ACTivity? query returns edge activity since the last :ACTivity? query, you must send this query twice before the edge activity result is valid.

Return Format

<edges>,<levels><NL>

<edges> ::= presence of edges (16-bit integer in NR1 format).

<levels> ::= logical highs or lows (16-bit integer in NR1 format).

bit 0 ::= DIGital 0

bit 15 ::= DIGital 15

NOTE

A bit = 0 (zero) in the <edges> result indicates that no edges were detected on that channel (across the specified threshold voltage) since the last query.

A bit = 1 (one) in the <edges> result indicates that edges have been detected on that channel (across the specified threshold voltage) since the last query.

(The threshold voltage must be set appropriately for the logic levels of the signals being probed.)

- See Also**
- ["Introduction to Root \(: \) Commands"](#) on page 133
 - [":POD<n>:THReshold"](#) on page 382
 - [":DIGital<n>:THReshold"](#) on page 234

:AER (Arm Event Register)

C (see [page 740](#))

Query Syntax :AER?

The AER query reads the Arm Event Register. After the Arm Event Register is read, it is cleared. A "1" indicates the trigger system is in the armed state, ready to accept a trigger.

The Armed Event Register is summarized in the Wait Trig bit of the Operation Status Event Register. A Service Request can be generated when the Wait Trig bit transitions and the appropriate enable bits have been set in the Operation Status Enable Register (OPEE) and the Service Request Enable Register (SRE).

Return Format <value><NL>

<value> ::= {0 | 1}; an integer in NR1 format.

- See Also**
- ["Introduction to Root \(: \) Commands"](#) on page 133
 - [":OPEE \(Operation Status Enable Register\)"](#) on page 155
 - [":OPERRegister:CONDition \(Operation Status Condition Register\)"](#) on page 157
 - [":OPERRegister\[:EVENT\] \(Operation Status Event Register\)"](#) on page 159
 - ["*STB \(Read Status Byte\)"](#) on page 126
 - ["*SRE \(Service Request Enable\)"](#) on page 124

:AUToscale

C (see [page 740](#))

Command Syntax

```
:AUToscale
```

```
:AUToscale [<source>[,...,<source>]]
```

```
<source> ::= CHANnel<n> for the DSO models
```

```
<source> ::= {DIGital0,...,DIGital15 | POD1 | POD2 | CHANnel<n>} for the  
MSO models
```

```
<n> ::= {1 | 2 | 3 | 4} for the four channel oscilloscope models
```

```
<n> ::= {1 | 2} for the two channel oscilloscope models
```

The <source> parameter may be repeated up to 5 times.

The :AUToscale command evaluates all input signals and sets the correct conditions to display the signals. This is the same as pressing the Autoscale key on the front panel.

If one or more sources are specified, those specified sources will be enabled and all others blanked. The autoscale channels mode (see "[:AUToscale:CHANnels](#)" on page 139) is set to DISplayed channels. Then, the autoscale is performed.

When the :AUToscale command is sent, the following conditions are affected and actions are taken:

- Thresholds.
- Channels with activity around the trigger point are turned on, others are turned off.
- Channels are reordered on screen; analog channel 1 first, followed by the remaining analog channels, then the digital channels 0-15.
- Delay is set to 0 seconds.
- Time/Div.

The :AUToscale command does not affect the following conditions:

- Label names.
- Trigger conditioning.

The :AUToscale command turns off the following items:

- Cursors.
- Measurements.
- Trace memories.
- Zoomed (delayed) time base mode.

For further information on :AUToscale, see the *User's Guide*.

- See Also**
- ["Introduction to Root \(: \) Commands"](#) on page 133
 - [":AUToscale:CHANnels"](#) on page 139
 - [":AUToscale:AMODE"](#) on page 138

Example Code

```
' AUTOSCALE - This command evaluates all the input signals and sets  
' the correct conditions to display all of the active signals.  
myScope.WriteString ":AUTOSCALE" ' Same as pressing Autoscale key.
```

Example program from the start: ["VISA COM Example in Visual Basic"](#) on page 828

:AUToscale:AMODE

N (see [page 740](#))

Command Syntax :AUToscale:AMODE <value>
<value> ::= {NORMal | CURRent}

The :AUToscale:AMODE command specifies the acquisition mode that is set by subsequent :AUToscales.

- When NORMal is selected, an :AUToscale command sets the NORMal acquisition type and the RTIME (real-time) acquisition mode.
- When CURRent is selected, the current acquisition type and mode are kept on subsequent :AUToscales.

Use the :ACQUIRE:TYPE and :ACQUIRE:MODE commands to set the acquisition type and mode.

Query Syntax :AUToscale:AMODE?

The :AUToscale:AMODE? query returns the autoscale acquire mode setting.

Return Format <value><NL>
<value> ::= {NORM | CURR}

- See Also**
- ["Introduction to Root \(: \) Commands"](#) on page 133
 - [":AUToscale"](#) on page 136
 - [":AUToscale:CHANnels"](#) on page 139
 - [":ACQUIRE:TYPE"](#) on page 188
 - [":ACQUIRE:MODE"](#) on page 179

:AUToscale:CHANnels

N (see [page 740](#))

Command Syntax :AUToscale:CHANnels <value>
 <value> ::= {ALL | DISplayed}

The :AUToscale:CHANnels command specifies which channels will be displayed on subsequent :AUToscales.

- When ALL is selected, all channels that meet the requirements of :AUToscale will be displayed.
- When DISplayed is selected, only the channels that are turned on are autoscaled.

Use the :VIEW or :BLANK root commands to turn channels on or off.

Query Syntax :AUToscale:CHANnels?

The :AUToscale:CHANnels? query returns the autoscale channels setting.

Return Format <value><NL>
 <value> ::= {ALL | DISP}

- See Also**
- "[Introduction to Root \(: \) Commands](#)" on page 133
 - "[:AUToscale](#)" on page 136
 - "[:AUToscale:AMODE](#)" on page 138
 - "[:VIEW](#)" on page 172
 - "[:BLANK](#)" on page 140

:BLANK

N (see [page 740](#))

Command Syntax :BLANK [<source>]

<source> ::= {CHANnel<n> | FUNCTION | MATH | SBUS} for the DSO models

<source> ::= {CHANnel<n> | DIGital0,...,DIGital15 | POD{1 | 2}
| BUS{1 | 2} | FUNCTION | MATH | SBUS} for the MSO models

<n> ::= {1 | 2 | 3 | 4} for the four channel oscilloscope models

<n> ::= {1 | 2} for the two channel oscilloscope models

The :BLANK command turns off (stops displaying) the specified channel, digital pod, math function, or serial decode bus. The :BLANK command with no parameter turns off all sources.

NOTE

To turn on (start displaying) a channel, etc., use the :VIEW command. The DISPLAY commands, :CHANnel<n>:DISPlay, :FUNCTION:DISPlay, :POD<n>:DISPlay, or :DIGital<n>:DISPlay, are the preferred method to turn on/off a channel, etc.

NOTE

MATH is an alias for FUNCTION.

- See Also**
- "[Introduction to Root \(: \) Commands](#)" on page 133
 - "[:CDISplay](#)" on page 141
 - "[:CHANnel<n>:DISPlay](#)" on page 214
 - "[:DIGital<n>:DISPlay](#)" on page 230
 - "[:FUNCTION:DISPlay](#)" on page 259
 - "[:POD<n>:DISPlay](#)" on page 380
 - "[:STATus](#)" on page 169
 - "[:VIEW](#)" on page 172

- Example Code**
- "[Example Code](#)" on page 172

:CDISplay

C (see [page 740](#))

Command Syntax :CDISplay

The :CDISplay command clears the display and resets all associated measurements. If the oscilloscope is stopped, all currently displayed data is erased. If the oscilloscope is running, all the data in active channels and functions is erased; however, new data is displayed on the next acquisition.

- See Also**
- "[Introduction to Root \(:\)](#) Commands" on page 133
 - "[:DISPlay:CLEar](#)" on page 237

:DIGitize

C (see [page 740](#))

Command Syntax :DIGitize [<source>[,...,<source>]]

<source> ::= {CHANnel<n> | FUNction | MATH | SBUS} for the DSO models

<source> ::= {CHANnel<n> | DIGital0,...,DIGital15 | POD{1 | 2} | BUS{1 | 2} | FUNction | MATH | SBUS} for the MSO models

<n> ::= {1 | 2 | 3 | 4} for the four channel oscilloscope models

<n> ::= {1 | 2} for the two channel oscilloscope models

The <source> parameter may be repeated up to 5 times.

The :DIGitize command is a specialized RUN command. It causes the instrument to acquire waveforms according to the settings of the :ACQUIRE commands subsystem. When the acquisition is complete, the instrument is stopped. If no argument is given, :DIGitize acquires the channels currently displayed. If no channels are displayed, all channels are acquired.

NOTE

To halt a :DIGitize in progress, use the device clear command.

NOTE

MATH is an alias for FUNction.

- See Also**
- "[Introduction to Root \(: \) Commands](#)" on page 133
 - "[:RUN](#)" on page 166
 - "[:SINGLE](#)" on page 168
 - "[:STOP](#)" on page 170
 - "[:ACQUIRE Commands](#)" on page 173
 - "[:WAVEFORM Commands](#)" on page 573

Example Code

```
' DIGITIZE - Used to acquire the waveform data for transfer over
' the interface. Sending this command causes an acquisition to
' take place with the resulting data being placed in the buffer.
'
' NOTE! The DIGITIZE command is highly recommended for triggering
' modes other than SINGLE. This ensures that sufficient data is
' available for measurement. If DIGITIZE is used with single mode,
' the completion criteria may never be met. The number of points
' gathered in Single mode is related to the sweep speed, memory
' depth, and maximum sample rate. For example, take an oscilloscope
' with a 1000-point memory, a sweep speed of 10 us/div (100 us
' total time across the screen), and a 20 MSa/s maximum sample rate.
' 1000 divided by 100 us equals 10 MSa/s. Because this number is
```

```
' less than or equal to the maximum sample rate, the full 1000 points
' will be digitized in a single acquisition. Now, use 1 us/div
' (10 us across the screen). 1000 divided by 10 us equals 100 MSa/s;
' because this is greater than the maximum sample rate by 5 times,
' only 400 points (or 1/5 the points) can be gathered on a single
' trigger. Keep in mind when the oscilloscope is running,
' communication with the computer interrupts data acquisition.
' Setting up the oscilloscope over the bus causes the data buffers
' to be cleared and internal hardware to be reconfigured. If a
' measurement is immediately requested, there may have not been
' enough time for the data acquisition process to collect data, and
' the results may not be accurate. An error value of 9.9E+37 may be
' returned over the bus in this situation.
'
```

myScope.WriteString ":DIGITIZE CHAN1"

Example program from the start: ["VISA COM Example in Visual Basic"](#) on page 828

:HWEenable (Hardware Event Enable Register)

N (see page 740)

Command Syntax :HWEenable <mask>
 <mask> ::= 16-bit integer

The :HWEenable command sets a mask in the Hardware Event Enable register. Set any of the following bits to "1" to enable bit 12 in the Operation Status Condition Register and potentially cause an SRQ (Service Request interrupt) to be generated.

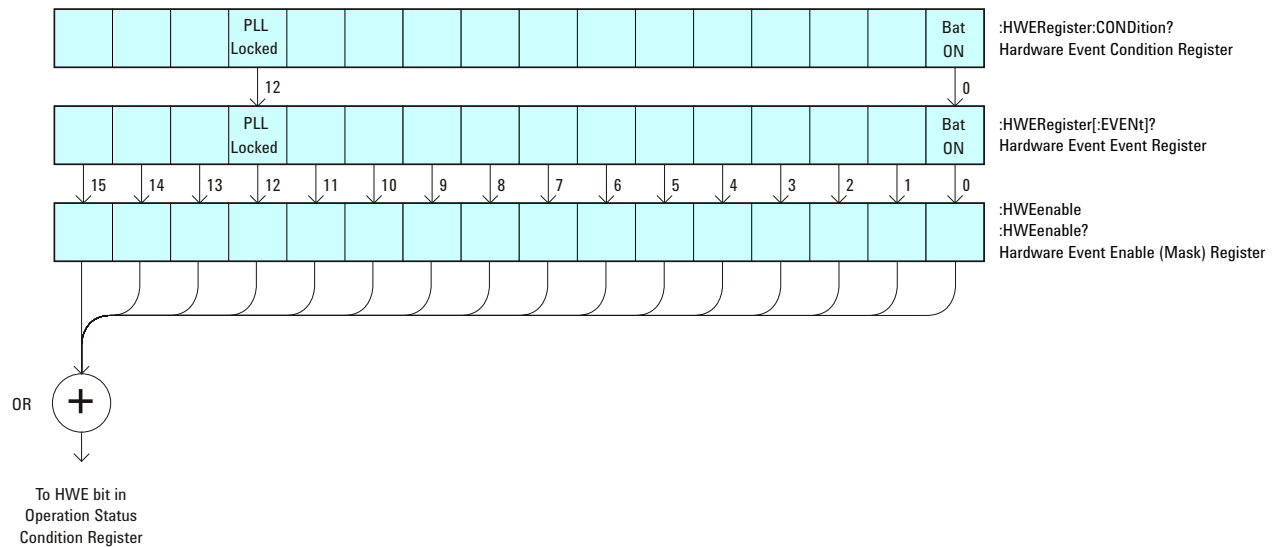

Table 43 Hardware Event Enable Register (HWEenable)

Bit	Name	Description	When Set (1 = High = True), Enables:
15-13	---	---	(Not used.)
12	PLL Locked	PLL Locked	This bit is for internal use and is not intended for general use.
11-1	---	---	(Not used.)
0	Bat On	Battery On	Event when the battery is on.

Query Syntax :HWEenable?

The :HWEenable? query returns the current value contained in the Hardware Event Enable register as an integer number.

Return Format <value><NL>

<value> ::= integer in NR1 format.

- See Also**
- "Introduction to Root (:) Commands" on page 133
 - ":AER (Arm Event Register)" on page 135
 - ":CHANnel<n>:PROTection" on page 223
 - ":EXTeRnal:PROTection" on page 252
 - ":OPERegister[:EVENT] (Operation Status Event Register)" on page 159
 - ":OVLenable (Overload Event Enable Register)" on page 161
 - ":OVLRegister (Overload Event Register)" on page 163
 - "**STB (Read Status Byte)" on page 126
 - "**SRE (Service Request Enable)" on page 124

:HWERegister:CONDition (Hardware Event Condition Register)

N (see page 740)

Query Syntax :HWERegister:CONDition?

The :HWERegister:CONDition? query returns the integer value contained in the Hardware Event Condition Register.

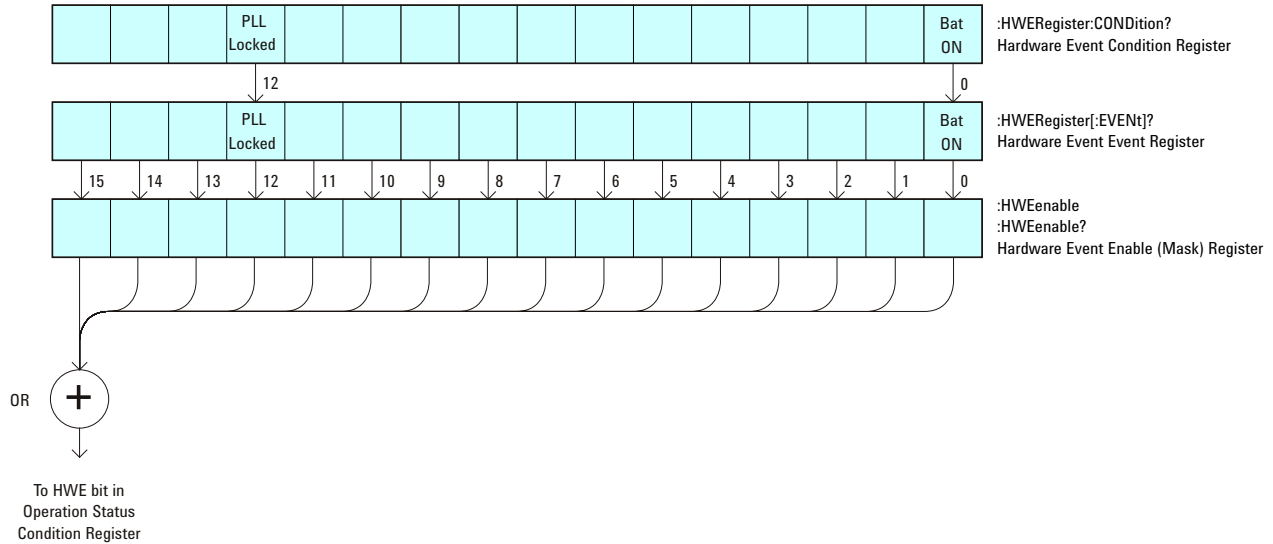

Table 44 Hardware Event Condition Register

Bit	Name	Description	When Set (1 = High = True), Indicates:
15-13	---	---	(Not used.)
12	PLL Locked	PLL Locked	This bit is for internal use and is not intended for general use.
11-1	---	---	(Not used.)
0	Bat On	Battery On	The battery is on.

Return Format <value><NL>

<value> ::= integer in NR1 format.

- See Also**
- "Introduction to Root (:) Commands" on page 133
 - ":CHANnel<n>:PROTEction" on page 223
 - ":EXTernal:PROTEction" on page 252
 - ":OPEE (Operation Status Enable Register)" on page 155
 - ":OPERegister[:EVENT] (Operation Status Event Register)" on page 159

- ":OVLenable (Overload Event Enable Register)" on page 161
- ":OVLRegister (Overload Event Register)" on page 163
- "*STB (Read Status Byte)" on page 126
- "*SRE (Service Request Enable)" on page 124

:HWERegister[:EVENT] (Hardware Event Event Register)

N (see page 740)

Query Syntax :HWERegister[:EVENT]?

The :HWERegister[:EVENT]? query returns the integer value contained in the Hardware Event Event Register.

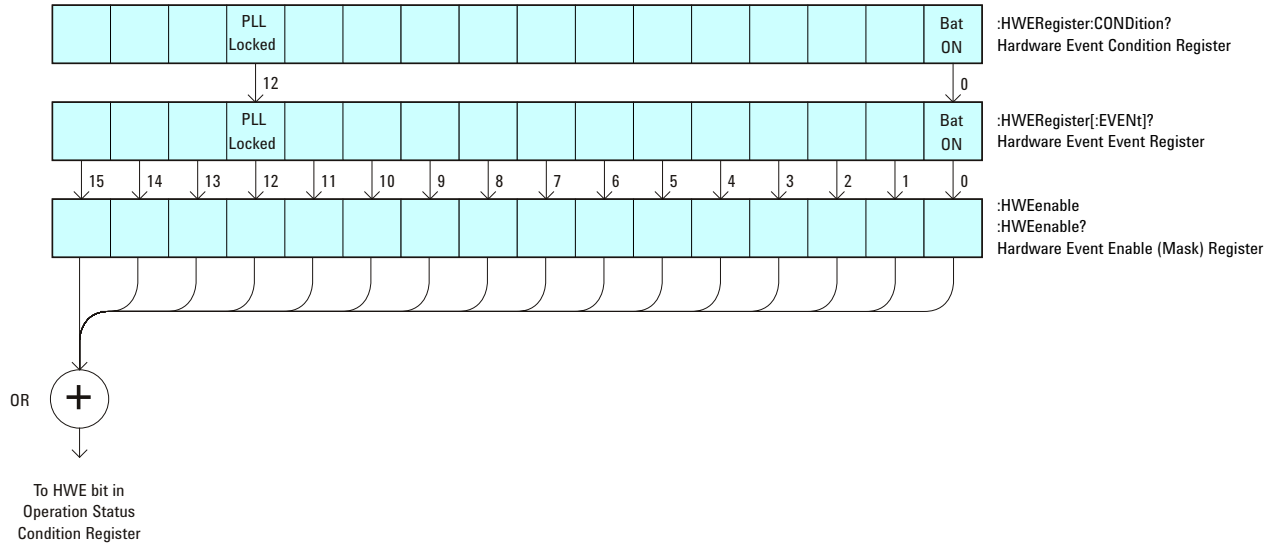

Table 45 Hardware Event Event Register

Bit	Name	Description	When Set (1 = High = True), Indicates:
15-13	---	---	(Not used.)
12	PLL Locked	PLL Locked	This bit is for internal use and is not intended for general use.
11-1	---	---	(Not used.)
0	Bat On	Battery On	The battery is on.

Return Format <value><NL>
<value> ::= integer in NR1 format.

- See Also**
- "Introduction to Root (:) Commands" on page 133
 - ":CHANnel<n>:PROTection" on page 223
 - ":EXTeRnal:PROTection" on page 252
 - ":OPEE (Operation Status Enable Register)" on page 155

- ":OPERRegister:CONDition (Operation Status Condition Register)" on page 157
- ":OVLenable (Overload Event Enable Register)" on page 161
- ":OVLRegister (Overload Event Register)" on page 163
- "*STB (Read Status Byte)" on page 126
- "*SRE (Service Request Enable)" on page 124

:MERGe

N (see [page 740](#))

Command Syntax :MERGe <pixel memory>

```
<pixel memory> ::= {PMEemory0 | PMEemory1 | PMEemory2 | PMEemory3  
                  | PMEemory4 | PMEemory5 | PMEemory6 | PMEemory7  
                  | PMEemory8 | PMEemory9}
```

The :MERGe command stores the contents of the active display in the specified pixel memory. The previous contents of the pixel memory are overwritten. The pixel memories are PMEemory0 through PMEemory9. This command is similar to the function of the "Save To: INTERN_<n>" key in the Save/Recall menu.

- See Also**
- ["Introduction to Root \(: \) Commands"](#) on page 133
 - ["*SAV \(Save\)"](#) on page 123
 - ["*RCL \(Recall\)"](#) on page 119
 - [":VIEW"](#) on page 172
 - [":BLANK"](#) on page 140

:MTEenable (Mask Test Event Enable Register)

N (see page 740)

Command Syntax :MTEenable <mask>
 <mask> ::= 16-bit integer

The :MTEenable command sets a mask in the Mask Test Event Enable register. Set any of the following bits to "1" to enable bit 9 in the Operation Status Condition Register and potentially cause an SRQ (Service Request interrupt) to be generated.

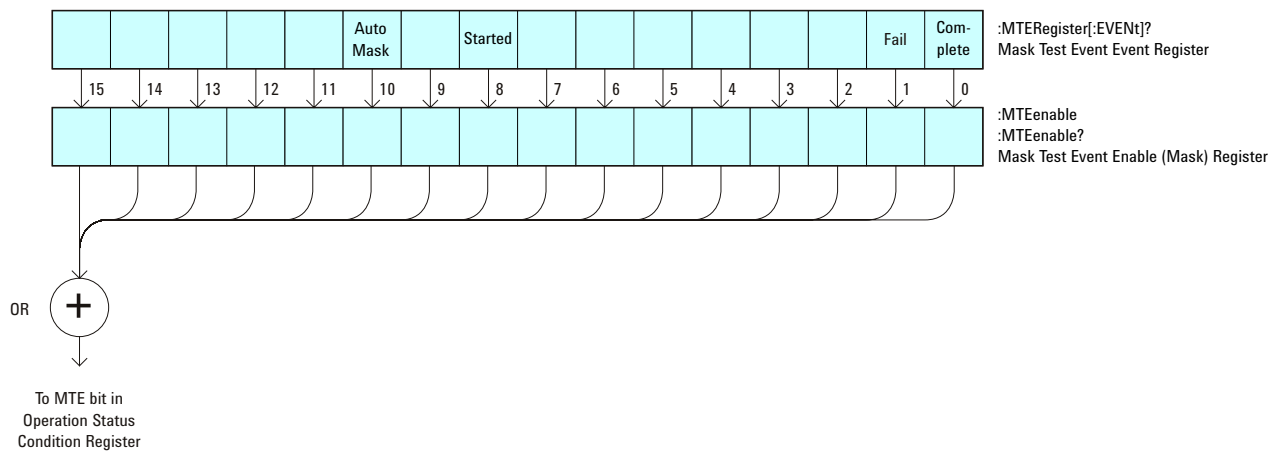

Table 46 Mask Test Event Enable Register (MTEenable)

Bit	Name	Description	When Set (1 = High = True), Enables:
15-11	---	---	(Not used.)
10	Auto Mask	Auto Mask Created	Auto mask creation completed.
9	---	---	(Not used.)
8	Started	Mask Testing Started	Mask testing started.
7-2	---	---	(Not used.)
1	Fail	Mask Test Fail	Mask test failed.
0	Complete	Mask Test Complete	Mask test is complete.

Query Syntax :MTEenable?

The :MTEenable? query returns the current value contained in the Mask Test Event Enable register as an integer number.

5 Commands by Subsystem

Return Format <value><NL>

<value> ::= integer in NR1 format.

- See Also**
- ["Introduction to Root \(: \) Commands"](#) on page 133
 - [":AER \(Arm Event Register\)"](#) on page 135
 - [":CHANnel<n>:PROTection"](#) on page 223
 - [":EXTernal:PROTection"](#) on page 252
 - [":OPERegister\[:EVENT\] \(Operation Status Event Register\)"](#) on page 159
 - [":OVLenable \(Overload Event Enable Register\)"](#) on page 161
 - [":OVLRegister \(Overload Event Register\)"](#) on page 163
 - ["*STB \(Read Status Byte\)"](#) on page 126
 - ["*SRE \(Service Request Enable\)"](#) on page 124

:MTERegister[:EVENT] (Mask Test Event Event Register)

N (see page 740)

Query Syntax :MTERegister[:EVENT]?

The :MTERegister[:EVENT]? query returns the integer value contained in the Mask Test Event Event Register and clears the register.

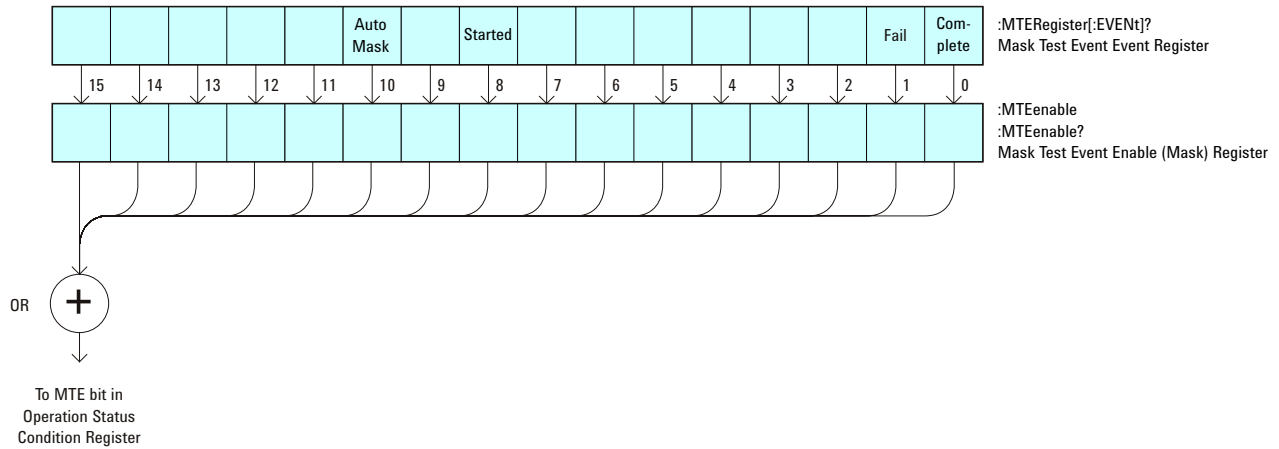

Table 47 Mask Test Event Event Register

Bit	Name	Description	When Set (1 = High = True), Indicates:
15-11	---	---	(Not used.)
10	Auto Mask	Auto Mask Created	Auto mask creation completed.
9	---	---	(Not used.)
8	Started	Mask Testing Started	Mask testing started.
7-2	---	---	(Not used.)
1	Fail	Mask Test Fail	The mask test failed.
0	Complete	Mask Test Complete	The mask test is complete.

Return Format <value><NL>
<value> ::= integer in NR1 format.

- See Also**
- "Introduction to Root (:) Commands" on page 133
 - ":CHANnel<n>:PROTection" on page 223
 - ":EXTernal:PROTection" on page 252

5 Commands by Subsystem

- ":OPEE (Operation Status Enable Register)" on page 155
- ":OPERegister:CONDition (Operation Status Condition Register)" on page 157
- ":OVLenable (Overload Event Enable Register)" on page 161
- ":OVLRegister (Overload Event Register)" on page 163
- "*STB (Read Status Byte)" on page 126
- "*SRE (Service Request Enable)" on page 124

:OPEE (Operation Status Enable Register)

C (see page 740)

Command Syntax :OPEE <mask>
 <mask> ::= 16-bit integer

The :OPEE command sets a mask in the Operation Status Enable register. Set any of the following bits to "1" to enable bit 7 in the Status Byte Register and potentially cause an SRQ (Service Request interrupt) to be generated.

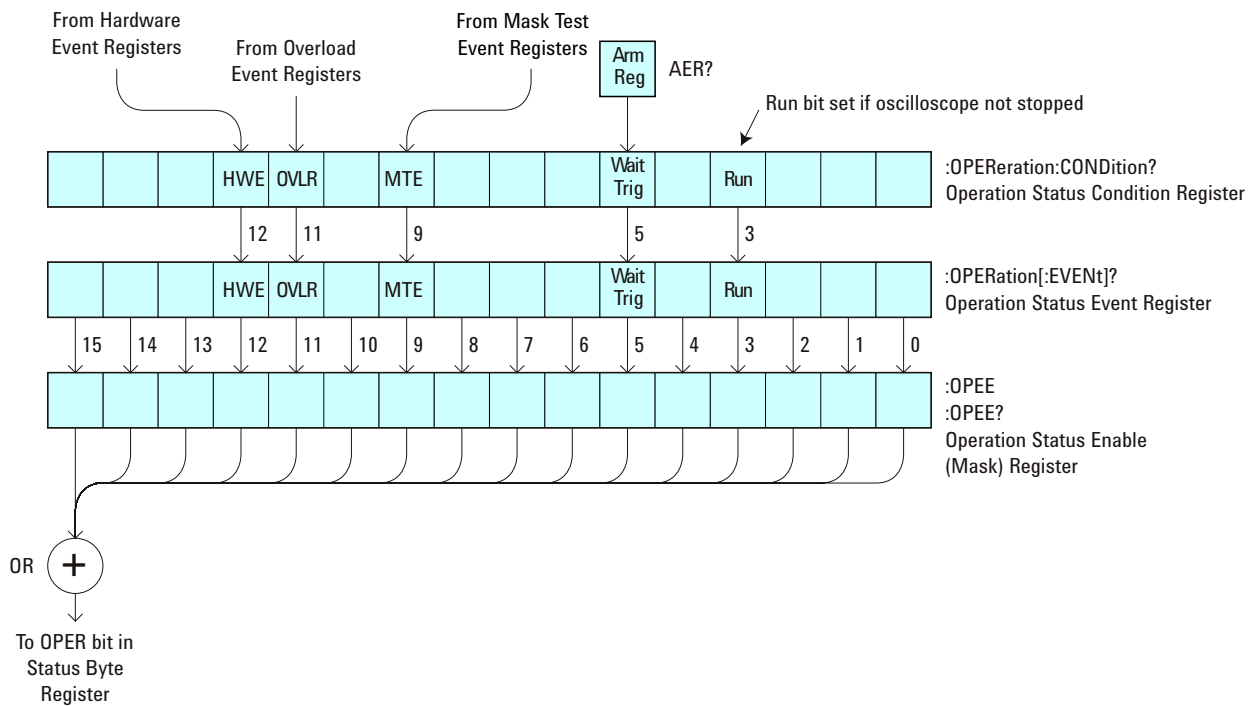

Table 48 Operation Status Enable Register (OPEE)

Bit	Name	Description	When Set (1 = High = True), Enables:
15-13	---	---	(Not used.)
12	HWE	Hardware Event	Event when hardware event occurs.
11	OVL	Overload	Event when 50Ω input overload occurs.
10	---	---	(Not used.)
9	MTE	Mask Test Event	Event when mask test event occurs.
8-6	---	---	(Not used.)

Table 48 Operation Status Enable Register (OPEE) (continued)

Bit	Name	Description	When Set (1 = High = True), Enables:
5	Wait Trig	Wait Trig	Event when the trigger is armed.
4	---	---	(Not used.)
3	Run	Running	Event when the oscilloscope is running (not stopped).
2-0	---	---	(Not used.)

Query Syntax :OPEE?

The :OPEE? query returns the current value contained in the Operation Status Enable register as an integer number.

Return Format <value><NL>

<value> ::= integer in NR1 format.

- See Also**
- ["Introduction to Root \(: \) Commands"](#) on page 133
 - [":AER \(Arm Event Register\)"](#) on page 135
 - [":CHANnel<n>:PROTection"](#) on page 223
 - [":EXTeRnal:PROTection"](#) on page 252
 - [":OPERegister\[:EVENT\] \(Operation Status Event Register\)"](#) on page 159
 - [":OVLenable \(Overload Event Enable Register\)"](#) on page 161
 - [":OVLRegister \(Overload Event Register\)"](#) on page 163
 - ["*STB \(Read Status Byte\)"](#) on page 126
 - ["*SRE \(Service Request Enable\)"](#) on page 124

:OPERRegister:CONDition (Operation Status Condition Register)

C (see page 740)

Query Syntax :OPERRegister:CONDition?

The :OPERRegister:CONDition? query returns the integer value contained in the Operation Status Condition Register.

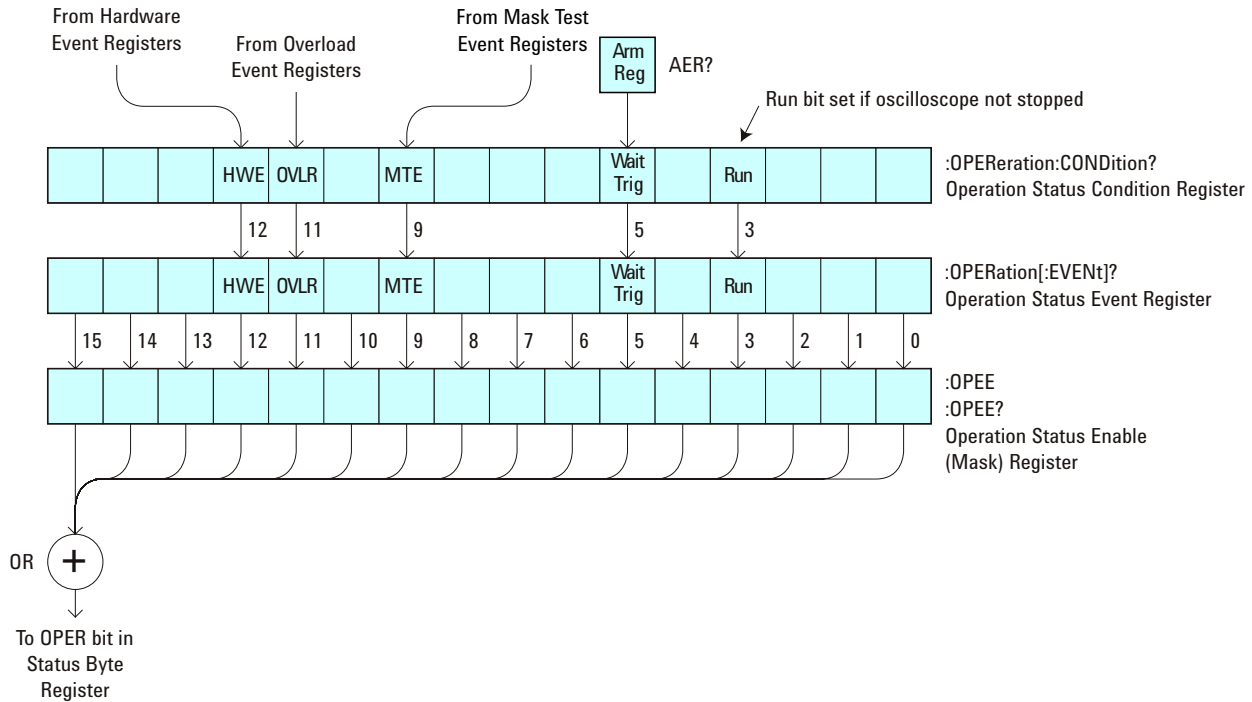

Table 49 Operation Status Condition Register

Bit	Name	Description	When Set (1 = High = True), Indicates:
15-13	---	---	(Not used.)
12	HWE	Hardware Event	A hardware event has occurred..
11	OVL	Overload	A 50Ω input overload has occurred.
10	---	---	(Not used.)
9	MTE	Mask Test Event	A mask test event has occurred.
8-6	---	---	(Not used.)
5	Wait Trig	Wait Trig	The trigger is armed (set by the Trigger Armed Event Register (TER)).
4	---	---	(Not used.)

Table 49 Operation Status Condition Register (continued)

Bit	Name	Description	When Set (1 = High = True), Indicates:
3	Run	Running	The oscilloscope is running (not stopped).
2-0	---	---	(Not used.)

Return Format <value><NL>

<value> ::= integer in NR1 format.

- See Also**
- ["Introduction to Root \(: \) Commands"](#) on page 133
 - [":CHANnel<n>:PROTection"](#) on page 223
 - [":EXTeRnal:PROTection"](#) on page 252
 - [":OPEE \(Operation Status Enable Register\)"](#) on page 155
 - [":OPERegister\[:EVENT\] \(Operation Status Event Register\)"](#) on page 159
 - [":OVLenable \(Overload Event Enable Register\)"](#) on page 161
 - [":OVLRegister \(Overload Event Register\)"](#) on page 163
 - ["*STB \(Read Status Byte\)"](#) on page 126
 - ["*SRE \(Service Request Enable\)"](#) on page 124
 - [":HWERegister\[:EVENT\] \(Hardware Event Event Register\)"](#) on page 148
 - [":HWEenable \(Hardware Event Enable Register\)"](#) on page 144
 - [":MTERegister\[:EVENT\] \(Mask Test Event Event Register\)"](#) on page 153
 - [":MTEenable \(Mask Test Event Enable Register\)"](#) on page 151

:OPERRegister[:EVENT] (Operation Status Event Register)

C (see page 740)

Query Syntax :OPERRegister[:EVENT]?

The :OPERRegister[:EVENT]? query returns the integer value contained in the Operation Status Event Register.

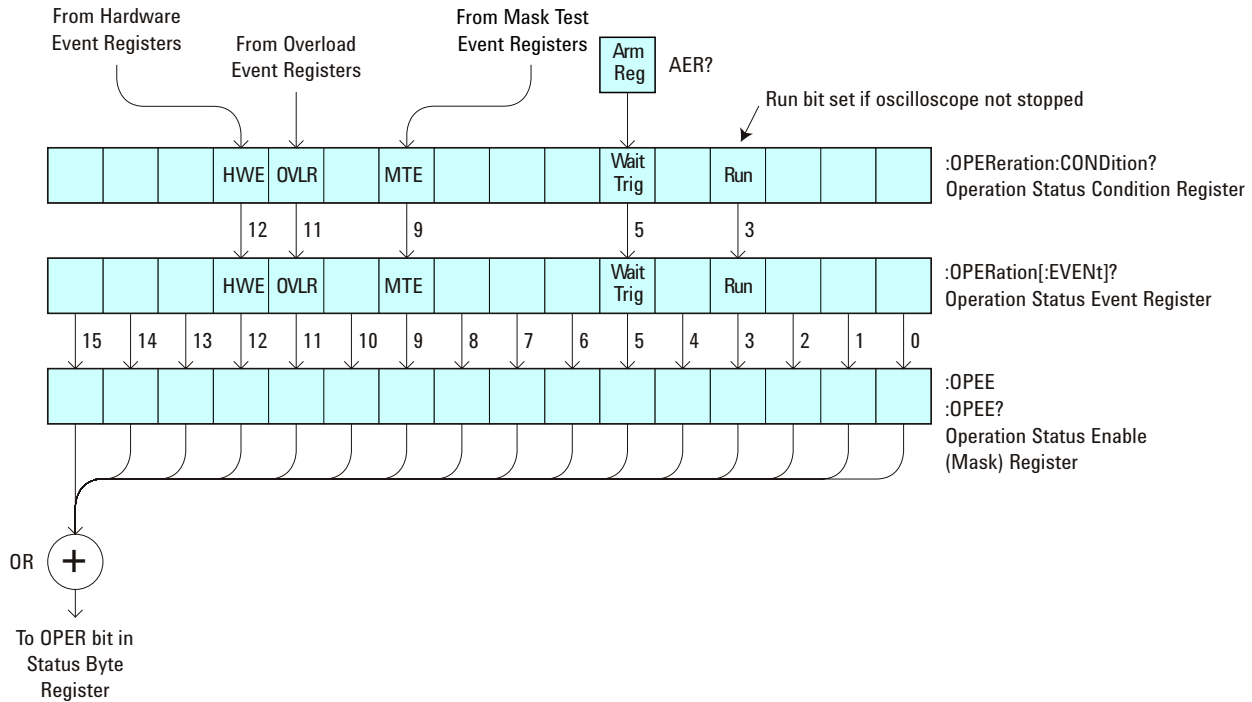

Table 50 Operation Status Event Register

Bit	Name	Description	When Set (1 = High = True), Indicates:
15-13	---	---	(Not used.)
12	HWE	Hardware Event	A hardware event has occurred.
11	OVL	Overload	A 50Ω input overload has occurred.
10	---	---	(Not used.)
9	MTE	Mask Test Event	A mask test event has occurred.
8-6	---	---	(Not used.)
5	Wait Trig	Wait Trig	The trigger is armed (set by the Trigger Armed Event Register (TER)).
4	---	---	(Not used.)

Table 50 Operation Status Event Register (continued)

Bit	Name	Description	When Set (1 = High = True), Indicates:
3	Run	Running	The oscilloscope has gone from a stop state to a single or running state.
2-0	---	---	(Not used.)

Return Format <value><NL>

<value> ::= integer in NR1 format.

- See Also**
- ["Introduction to Root \(: \) Commands"](#) on page 133
 - [":CHANnel<n>:PROTection"](#) on page 223
 - [":EXTeRnal:PROTection"](#) on page 252
 - [":OPEE \(Operation Status Enable Register\)"](#) on page 155
 - [":OPERegister:CONDition \(Operation Status Condition Register\)"](#) on page 157
 - [":OVLenable \(Overload Event Enable Register\)"](#) on page 161
 - [":OVLRegister \(Overload Event Register\)"](#) on page 163
 - ["*STB \(Read Status Byte\)"](#) on page 126
 - ["*SRE \(Service Request Enable\)"](#) on page 124
 - [":HWERegister\[:EVENT\] \(Hardware Event Event Register\)"](#) on page 148
 - [":HWEenable \(Hardware Event Enable Register\)"](#) on page 144
 - [":MTERegister\[:EVENT\] \(Mask Test Event Event Register\)"](#) on page 153
 - [":MTEenable \(Mask Test Event Enable Register\)"](#) on page 151

:OVLenable (Overload Event Enable Register)

C (see page 740)

Command Syntax :OVLenable <enable_mask>
 <enable_mask> ::= 16-bit integer

The overload enable mask is an integer representing an input as described in the following table.

The :OVLenable command sets the mask in the Overload Event Enable Register and enables the reporting of the Overload Event Register. If an overvoltage is sensed on a 50Ω input, the input will automatically switch to 1 MΩ input impedance. If enabled, such an event will set bit 11 in the Operation Status Register.

NOTE

You can set analog channel input impedance to 50Ω on the 300 MHz, 500 MHz, and 1 GHz bandwidth oscilloscope models. On these same bandwidth models, if there are only two analog channels, you can also set external trigger input impedance to 50Ω.

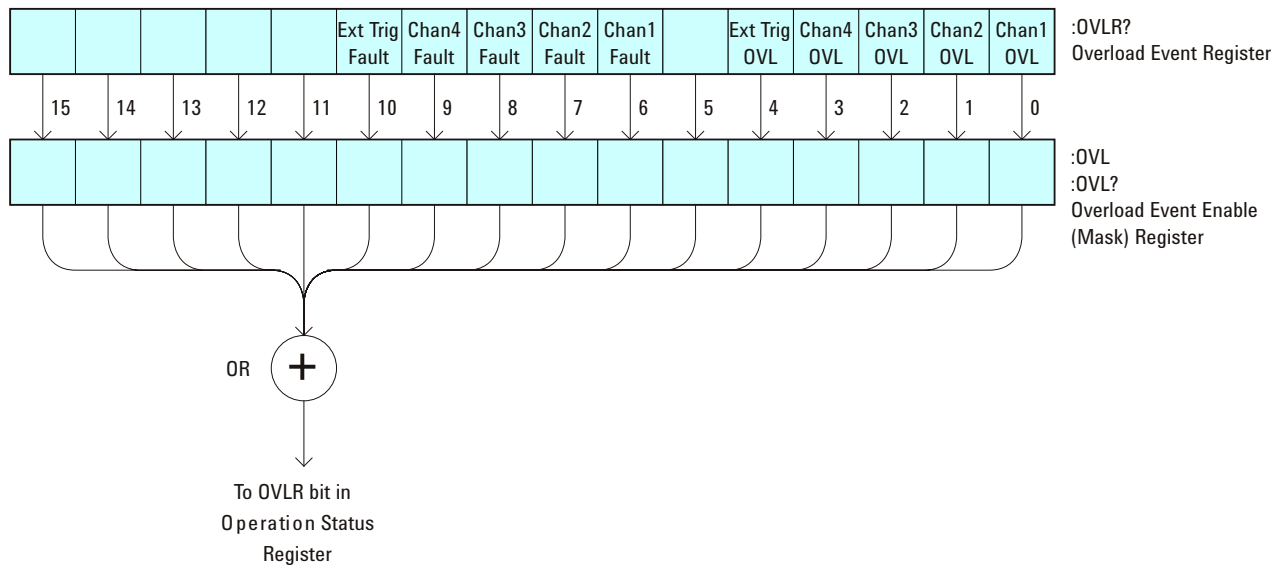

Table 51 Overload Event Enable Register (OVL)

Bit	Description	When Set (1 = High = True), Enables:
15-11	---	(Not used.)
10	External Trigger Fault	Event when fault occurs on External Trigger input.
9	Channel 4 Fault	Event when fault occurs on Channel 4 input.
8	Channel 3 Fault	Event when fault occurs on Channel 3 input.

Table 51 Overload Event Enable Register (OVL) (continued)

Bit	Description	When Set (1 = High = True), Enables:
7	Channel 2 Fault	Event when fault occurs on Channel 2 input.
6	Channel 1 Fault	Event when fault occurs on Channel 1 input.
5	---	(Not used.)
4	External Trigger OVL	Event when overload occurs on External Trigger input.
3	Channel 4 OVL	Event when overload occurs on Channel 4 input.
2	Channel 3 OVL	Event when overload occurs on Channel 3 input.
1	Channel 2 OVL	Event when overload occurs on Channel 2 input.
0	Channel 1 OVL	Event when overload occurs on Channel 1 input.

Query Syntax :OVLenable?

The :OVLenable query returns the current enable mask value contained in the Overload Event Enable Register.

Return Format <enable_mask><NL>

<enable_mask> ::= integer in NR1 format.

- See Also**
- "[Introduction to Root \(:\)](#) Commands" on page 133
 - "[:CHANnel<n>:PROTection](#)" on page 223
 - "[:EXTeRnal:PROTection](#)" on page 252
 - "[:OPEE \(Operation Status Enable Register\)](#)" on page 155
 - "[:OPERegister:CONDition \(Operation Status Condition Register\)](#)" on page 157
 - "[:OPERegister\[:EVENT\] \(Operation Status Event Register\)](#)" on page 159
 - "[:OVLRegister \(Overload Event Register\)](#)" on page 163
 - "[*STB \(Read Status Byte\)](#)" on page 126
 - "[*SRE \(Service Request Enable\)](#)" on page 124

:OVLRegister (Overload Event Register)

C (see page 740)

Query Syntax :OVLRegister?

The :OVLRegister query returns the overload protection value stored in the Overload Event Register (OVL). If an overvoltage is sensed on a 50Ω input, the input will automatically switch to 1 MΩ input impedance. A "1" indicates an overload has occurred.

NOTE

You can set analog channel input impedance to 50Ω on the 300 MHz, 500 MHz, and 1 GHz bandwidth oscilloscope models. On these same bandwidth models, if there are only two analog channels, you can also set external trigger input impedance to 50Ω.

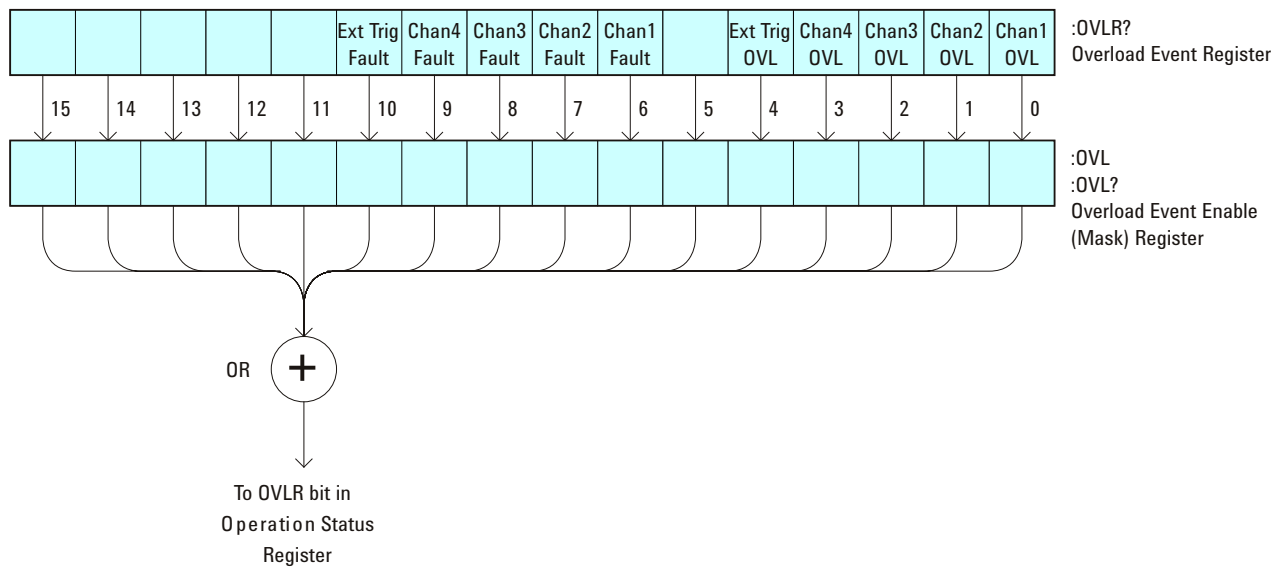

Table 52 Overload Event Register (OVL)

Bit	Description	When Set (1 = High = True), Indicates:
15-11	---	(Not used.)
10	External Trigger Fault	Fault has occurred on External Trigger input.
9	Channel 4 Fault	Fault has occurred on Channel 4 input.
8	Channel 3 Fault	Fault has occurred on Channel 3 input.
7	Channel 2 Fault	Fault has occurred on Channel 2 input.
6	Channel 1 Fault	Fault has occurred on Channel 1 input.
5	---	(Not used.)

Table 52 Overload Event Register (OVLr) (continued)

Bit	Description	When Set (1 = High = True), Indicates:
4	External Trigger OVL	Overload has occurred on External Trigger input.
3	Channel 4 OVL	Overload has occurred on Channel 4 input.
2	Channel 3 OVL	Overload has occurred on Channel 3 input.
1	Channel 2 OVL	Overload has occurred on Channel 2 input.
0	Channel 1 OVL	Overload has occurred on Channel 1 input.

Return Format <value><NL>

<value> ::= integer in NR1 format.

- See Also**
- ["Introduction to Root \(: \) Commands"](#) on page 133
 - [":CHANnel<n>:PROTection"](#) on page 223
 - [":EXTernal:PROTection"](#) on page 252
 - [":OPEE \(Operation Status Enable Register\)"](#) on page 155
 - [":OVLenable \(Overload Event Enable Register\)"](#) on page 161
 - ["*STB \(Read Status Byte\)"](#) on page 126
 - ["*SRE \(Service Request Enable\)"](#) on page 124

:PRINT

C (see [page 740](#))

Command Syntax

```
:PRINT [<options>]
```

```
<options> ::= [<print option>][,...,<print option>]
```

```
<print option> ::= {COLor | GRAYscale | PRINter0 | BMP8bit | BMP | PNG  
                  | NOFactors | FACTors}
```

The <print option> parameter may be repeated up to 5 times.

The PRINT command formats the output according to the currently selected format (device). If an option is not specified, the value selected in the Print Config menu is used. Refer to "[:HARDcopy:FORMat](#)" on page 662 for more information.

- See Also**
- "[Introduction to Root \(:\) Commands](#)" on page 133
 - "[Introduction to :HARDcopy Commands](#)" on page 273
 - "[:HARDcopy:FORMat](#)" on page 662
 - "[:HARDcopy:FACTors](#)" on page 276
 - "[:HARDcopy:GRAYscale](#)" on page 663
 - "[:DISPlay:DATA](#)" on page 238

:RUN

C (see [page 740](#))

Command Syntax :RUN

The :RUN command starts repetitive acquisitions. This is the same as pressing the Run key on the front panel.

- See Also**
- ["Introduction to Root \(: \) Commands"](#) on page 133
 - [":SINGLE"](#) on page 168
 - [":STOP"](#) on page 170

Example Code

```
' RUN_STOP - (not executed in this example)
' - RUN starts the data acquisition for the active waveform display.
' - STOP stops the data acquisition and turns off AUTOSTORE.
' myScope.WriteString ":RUN"      ' Start data acquisition.
' myScope.WriteString ":STOP"    ' Stop the data acquisition.
```

Example program from the start: ["VISA COM Example in Visual Basic"](#) on page 828

:SERial

N (see [page 740](#))

Query Syntax :SERial?

The :SERial? query returns the serial number of the instrument.

Return Format: Unquoted string<NL>

See Also • ["Introduction to Root \(: \) Commands"](#) on page 133

:SINGle

C (see [page 740](#))

Command Syntax :SINGle

The :SINGle command causes the instrument to acquire a single trigger of data. This is the same as pressing the Single key on the front panel.

- See Also**
- "[Introduction to Root \(:\)](#) Commands" on page 133
 - ":RUN" on page 166
 - ":STOP" on page 170

:STATus

N (see [page 740](#))

Query Syntax

:STATus? <source>

<source> ::= {CHANnel<n> | FUNCTION | MATH | SBUS} for the DSO models

<source> ::= {CHANnel<n> | DIGital0,...,DIGital15 | POD{1 | 2}
| BUS{1 | 2} | FUNCTION | MATH | SBUS} for the MSO models

<n> ::= {1 | 2 | 3 | 4} for the four channel oscilloscope models

<n> ::= {1 | 2} for the two channel oscilloscope models

The :STATus? query reports whether the channel, function, trace memory, or serial decode bus specified by <source> is displayed.

NOTE

MATH is an alias for FUNCTION.

Return Format

<value><NL>

<value> ::= {1 | 0}

See Also

- ["Introduction to Root \(: \) Commands"](#) on page 133
- [":BLANK"](#) on page 140
- [":CHANnel<n>:DISPlay"](#) on page 214
- [":DIGital<n>:DISPlay"](#) on page 230
- [":FUNCTION:DISPlay"](#) on page 259
- [":POD<n>:DISPlay"](#) on page 380
- [":VIEW"](#) on page 172

:STOP

C (see [page 740](#))

Command Syntax :STOP

The :STOP command stops the acquisition. This is the same as pressing the Stop key on the front panel.

- See Also**
- ["Introduction to Root \(:\) Commands"](#) on page 133
 - [":RUN"](#) on page 166
 - [":SINGLE"](#) on page 168

- Example Code**
- ["Example Code"](#) on page 166

:TER (Trigger Event Register)

C (see [page 740](#))

Query Syntax :TER?

The :TER? query reads the Trigger Event Register. After the Trigger Event Register is read, it is cleared. A one indicates a trigger has occurred. A zero indicates a trigger has not occurred.

The Trigger Event Register is summarized in the TRG bit of the Status Byte Register (STB). A Service Request (SRQ) can be generated when the TRG bit of the Status Byte transitions, and the TRG bit is set in the Service Request Enable register. The Trigger Event Register must be cleared each time you want a new service request to be generated.

Return Format <value><NL>

<value> ::= {1 | 0}; a 16-bit integer in NR1 format.

- See Also**
- ["Introduction to Root \(:\) Commands"](#) on page 133
 - ["*SRE \(Service Request Enable\)"](#) on page 124
 - ["*STB \(Read Status Byte\)"](#) on page 126

:VIEW

N (see [page 740](#))

Command Syntax :VIEW <source>

```
<source> ::= {CHANnel<n> | PMEMory0,...,PMEMory9 | FUNction | MATH
             | SBUS} for DSO models
```

```
<source> ::= {CHANnel<n> | DIGital0,...,DIGital15 | PMEMory0,...,PMEMory9
             | POD{1 | 2} | BUS{1 | 2} | FUNction | MATH | SBUS} for
             MSO models
```

```
<n> ::= {1 | 2 | 3 | 4} for the four channel oscilloscope models
```

```
<n> ::= {1 | 2} for the two channel oscilloscope models
```

The :VIEW command turns on the specified channel, function, trace memory, or serial decode bus.

NOTE

MATH is an alias for FUNction.

- See Also**
- "[Introduction to Root \(:\)](#) Commands" on page 133
 - "[:BLANK](#)" on page 140
 - "[:CHANnel<n>:DISPlay](#)" on page 214
 - "[:DIGital<n>:DISPlay](#)" on page 230
 - "[:FUNction:DISPlay](#)" on page 259
 - "[:POD<n>:DISPlay](#)" on page 380
 - "[:STATus](#)" on page 169

Example Code

```
' VIEW_BLANK - (not executed in this example)
' - VIEW turns on (starts displaying) a channel or pixel memory.
' - BLANK turns off (stops displaying) a channel or pixel memory.
' myScope.WriteString ":BLANK CHANNEL1"      ' Turn channel 1 off.
' myScope.WriteString ":VIEW CHANNEL1"      ' Turn channel 1 on.
```

Example program from the start: "[VISA COM Example in Visual Basic](#)" on page 828

:ACQUIRE Commands

Set the parameters for acquiring and storing data. See "Introduction to :ACQUIRE Commands" on page 173.

Table 53 :ACQUIRE Commands Summary

Command	Query	Options and Query Returns
n/a	:ACQUIRE:AAlias? (see page 175)	{1 0}
:ACQUIRE:COMPLETE <complete> (see page 176)	:ACQUIRE:COMPLETE? (see page 176)	<complete> ::= 100; an integer in NR1 format
:ACQUIRE:COUNT <count> (see page 177)	:ACQUIRE:COUNT? (see page 177)	<count> ::= an integer from 2 to 65536 in NR1 format
:ACQUIRE:DAALIAS <mode> (see page 178)	:ACQUIRE:DAALIAS? (see page 178)	<mode> ::= {DISABLE AUTO}
:ACQUIRE:MODE <mode> (see page 179)	:ACQUIRE:MODE? (see page 179)	<mode> ::= {RTIME ETIME SEGMENTED}
n/a	:ACQUIRE:POINTS? (see page 180)	<# points> ::= an integer in NR1 format
:ACQUIRE:RSIGNAL <ref_signal_mode> (see page 181)	:ACQUIRE:RSIGNAL? (see page 181)	<ref_signal_mode> ::= {OFF OUT IN}
:ACQUIRE:SEGMENTED:ANALYZE (see page 182)	n/a	n/a (with Option SGM)
:ACQUIRE:SEGMENTED:COUNT <count> (see page 183)	:ACQUIRE:SEGMENTED:COUNT? (see page 183)	<count> ::= an integer from 2 to 2000 in NR1 format (with Option SGM)
:ACQUIRE:SEGMENTED:INDEX <index> (see page 184)	:ACQUIRE:SEGMENTED:INDEX? (see page 184)	<index> ::= an integer from 2 to 2000 in NR1 format (with Option SGM)
n/a	:ACQUIRE:SRATE? (see page 187)	<sample_rate> ::= sample rate (samples/s) in NR3 format
:ACQUIRE:TYPE <type> (see page 188)	:ACQUIRE:TYPE? (see page 188)	<type> ::= {NORMAL AVERAGE HRESOLUTION PEAK}

Introduction to :ACQUIRE Commands The ACQUIRE subsystem controls the way in which waveforms are acquired. These acquisition types are available: normal, averaging, peak detect, and high resolution. Two acquisition modes are available: real-time mode, and equivalent-time mode.

Normal

The `:ACQUIRE:TYPE NORMAL` command sets the oscilloscope in the normal acquisition mode. For the majority of user models and signals, `NORMAL` mode yields the best oscilloscope picture of the waveform.

Averaging

The `:ACQUIRE:TYPE AVERAGE` command sets the oscilloscope in the averaging mode. You can set the count by sending the `:ACQUIRE:COUNT` command followed by the number of averages. In this mode, the value for averages is an integer from 2 to 65536. The `COUNT` value determines the number of averages that must be acquired.

High-Resolution

The `:ACQUIRE:TYPE HRESOLUTION` command sets the oscilloscope in the high-resolution mode (also known as *smoothing*). This mode is used to reduce noise at slower sweep speeds where the digitizer samples faster than needed to fill memory for the displayed time range. Instead of decimating samples, they are averaged together to provide the value for one display point. The slower the sweep speed, the greater the number of samples that are averaged together for each display point.

Peak Detect

The `:ACQUIRE:TYPE PEAK` command sets the oscilloscope in the peak detect mode. In this mode, `:ACQUIRE:COUNT` has no meaning.

Real-time Mode

The `:ACQUIRE:MODE RTIME` command sets the oscilloscope in real-time mode. This mode is useful to inhibit equivalent time sampling at fast sweep speeds.

Equivalent-time Mode

The `:ACQUIRE:MODE ETIME` command sets the oscilloscope in equivalent-time mode.

Reporting the Setup

Use `:ACQUIRE?` to query setup information for the `ACQUIRE` subsystem.

Return Format

The following is a sample response from the `:ACQUIRE?` query. In this case, the query was issued following a `*RST` command.

```
:ACQ:MODE RTIM;TYPE NORM;COMP 100;COUNT 8;SEGM:COUN 2
```

:ACQUIRE:AALIAS

N (see [page 740](#))

Query Syntax :ACQUIRE:AALIAS?

The :ACQUIRE:AALIAS? query returns the current state of the oscilloscope acquisition anti-alias control. This control can be directly disabled or disabled automatically.

Return Format <value><NL>
<value> ::= {1 | 0}

- See Also**
- "[Introduction to :ACQUIRE Commands](#)" on page 173
 - "[:ACQUIRE:DAALIAS](#)" on page 178

:ACQUIRE:COMPLETE

C (see [page 740](#))

Command Syntax :ACQUIRE:COMPLETE <complete>
 <complete> ::= 100; an integer in NR1 format

The :ACQUIRE:COMPLETE command affects the operation of the :DIGITIZE command. It specifies the minimum completion criteria for an acquisition. The parameter determines the percentage of the time buckets that must be "full" before an acquisition is considered complete. If :ACQUIRE:TYPE is NORMAL, it needs only one sample per time bucket for that time bucket to be considered full.

The only legal value for the :COMPLETE command is 100. All time buckets must contain data for the acquisition to be considered complete.

Query Syntax :ACQUIRE:COMPLETE?

The :ACQUIRE:COMPLETE? query returns the completion criteria (100) for the currently selected mode.

Return Format <completion_criteria><NL>
 <completion_criteria> ::= 100; an integer in NR1 format

- See Also**
- ["Introduction to :ACQUIRE Commands"](#) on page 173
 - [":ACQUIRE:TYPE"](#) on page 188
 - [":DIGITIZE"](#) on page 142
 - [":WAVEFORM:POINTS"](#) on page 586

Example Code

```
' ACQUIRE_COMPLETE - Specifies the minimum completion criteria for
' an acquisition. The parameter determines the percentage of time
' buckets needed to be "full" before an acquisition is considered
' to be complete.
myScope.WriteString ":ACQUIRE:COMPLETE 100"
```

Example program from the start: ["VISA COM Example in Visual Basic"](#) on page 828

:ACquire:COUNT

C (see [page 740](#))

Command Syntax :ACquire:COUNT <count>
 <count> ::= integer in NR1 format

In averaging mode, the :ACquire:COUNT command specifies the number of values to be averaged for each time bucket before the acquisition is considered to be complete for that time bucket. When :ACquire:TYPE is set to AVERage, the count can be set to any value from 2 to 65536.

NOTE

The :ACquire:COUNT 1 command has been deprecated. The AVERage acquisition type with a count of 1 is functionally equivalent to the HRESolution acquisition type; however, you should select the high-resolution acquisition mode with the :ACquire:TYPE HRESolution command instead.

Query Syntax :ACquire:COUNT?

The :ACquire:COUNT? query returns the currently selected count value for averaging mode.

Return Format <count_argument><NL>
 <count_argument> ::= an integer from 2 to 65536 in NR1 format

- See Also**
- ["Introduction to :ACquire Commands"](#) on page 173
 - [":ACquire:TYPE"](#) on page 188
 - [":DIGitize"](#) on page 142
 - [":WAVEform:COUNT"](#) on page 582

:ACQUIRE:DAALIAS

N (see [page 740](#))

Command Syntax :ACQUIRE:DAALIAS <mode>
<mode> ::= {DISABLE | AUTO}

The :ACQUIRE:DAALIAS command sets the disable anti-alias mode of the oscilloscope.

When set to DISABLE, anti-alias is always disabled. This is good for cases where dithered data is not desired.

When set to AUTO, the oscilloscope turns off anti-alias control as needed. Such cases are when the FFT or differentiate math functions are silent. The :DIGITIZE command always turns off the anti-alias control as well.

Query Syntax :ACQUIRE:DAALIAS?

The :ACQUIRE:DAALIAS? query returns the oscilloscope's current disable anti-alias mode setting.

Return Format <mode><NL>

<mode> ::= {DIS | AUTO}

- See Also**
- ["Introduction to :ACQUIRE Commands"](#) on page 173
 - [":ACQUIRE:AALIAS"](#) on page 175

:ACquire:MODE

C (see [page 740](#))

Command Syntax :ACquire:MODE <mode>

<mode> ::= {RTIME | ETIME | SEGmented}

The :ACquire:MODE command sets the acquisition mode of the oscilloscope.

- The :ACquire:MODE RTIME command sets the oscilloscope in real time mode. This mode is useful to inhibit equivalent time sampling at fast sweep speeds.

Real time mode is not available when averaging (:ACquire:TYPE AVERage).

NOTE

The obsolete command ACquire:TYPE:REALtime is functionally equivalent to sending ACquire:MODE RTIME; TYPE NORMAl.

- The :ACquire:MODE ETIME command sets the oscilloscope in equivalent time mode.
- The :ACquire:MODE SEGmented command sets the oscilloscope in segmented memory mode.

Query Syntax :ACquire:MODE?

The :ACquire:MODE? query returns the acquisition mode of the oscilloscope.

Return Format <mode_argument><NL>

<mode_argument> ::= {RTIM | ETIM | SEGM}

- See Also**
- ["Introduction to :ACquire Commands"](#) on page 173
 - [":ACquire:TYPE"](#) on page 188

:ACQUIRE:POINTS

C (see [page 740](#))

Query Syntax :ACQUIRE:POINTS?

The :ACQUIRE:POINTS? query returns the number of data points that the hardware will acquire from the input signal. The number of points acquired is not directly controllable. To set the number of points to be transferred from the oscilloscope, use the command :WAVEFORM:POINTS. The :WAVEFORM:POINTS? query will return the number of points available to be transferred from the oscilloscope.

Return Format <points_argument><NL>

<points_argument> ::= an integer in NR1 format

- See Also**
- ["Introduction to :ACQUIRE Commands"](#) on page 173
 - [":DIGITIZE"](#) on page 142
 - [":WAVEFORM:POINTS"](#) on page 586

:ACquire:RSIGnal

N (see [page 740](#))

Command Syntax :ACquire:RSIGnal <ref_signal_mode>
 <ref_signal_mode> ::= {OFF | OUT | IN}

The :ACquire:RSIGnal command selects the 10 MHz reference signal mode.

- The OFF mode disables the oscilloscope's 10 MHz REF BNC connector.
- The OUT mode is used to synchronize the timebase of two or more instruments.
- The IN mode is used to supply a sample clock to the oscilloscope. A 10 MHz square or sine wave signal is input to the BNC connector labeled 10 MHz REF. The amplitude must be between 180 mV and 1 V, with an offset of between 0 V and 2 V.

CAUTION

Do not apply more than ± 15 V at the 10 MHz REF BNC connector on the rear panel, or damage to the instrument may occur.

Query Syntax :ACquire:RSIGnal?

The :ACquire:RSIGnal? query returns the current 10 MHz reference signal mode.

Return Format <ref_signal_mode><NL>
 <ref_signal_mode> ::= {OFF | OUT | IN}

- See Also**
- [":TIMEbase:REFClock"](#) on page 447
 - The *Agilent InfiniiVision 7000 Series Oscilloscope User's Guide* for information on using the 10 MHz reference clock.

:ACQUIRE:SEGMENTED:ANALYZE

N (see [page 740](#))

Command Syntax :ACQUIRE:SEGMENTED:ANALYZE

NOTE

This command is available when the segmented memory option (Option SGM) is enabled.

This command calculates measurement statistics and/or infinite persistence over all segments that have been acquired. It corresponds to the front panel **Analyze Segments** softkey which appears in both the Measurement Statistics and Segmented Memory Menus.

In order to use this command, the oscilloscope must be stopped and in segmented acquisition mode, with either quick measurements or infinite persistence on.

- See Also**
- [":ACQUIRE:MODE"](#) on page 179
 - [":ACQUIRE:SEGMENTED:COUNT"](#) on page 183
 - ["Introduction to :ACQUIRE Commands"](#) on page 173

:ACquire:SEGmented:COUNT

N (see [page 740](#))

Command Syntax :ACquire:SEGmented:COUNT <count>
 <count> ::= an integer from 2 to 2000 in NR1 format

NOTE

This command is available when the segmented memory option (Option SGM) is enabled.

The :ACquire:SEGmented:COUNT command sets the number of memory segments to acquire.

The segmented memory acquisition mode is enabled with the :ACquire:MODE command, and data is acquired using the :DIGitize, :SINGLE, or :RUN commands. The number of memory segments in the current acquisition is returned by the :WAVEform:SEGmented:COUNT? query.

Query Syntax :ACquire:SEGmented:COUNT?

The :ACquire:SEGmented:COUNT? query returns the current count setting.

Return Format <count><NL>
 <count> ::= an integer from 2 to 2000 in NR1 format

- See Also**
- [":ACquire:MODE"](#) on page 179
 - [":DIGitize"](#) on page 142
 - [":SINGLE"](#) on page 168
 - [":RUN"](#) on page 166
 - [":WAVEform:SEGmented:COUNT"](#) on page 593
 - [":ACquire:SEGmented:ANALyze"](#) on page 182
 - ["Introduction to :ACquire Commands"](#) on page 173

Example Code • ["Example Code"](#) on page 184

:ACQUIRE:SEGMENTED:INDEX

N (see [page 740](#))

Command Syntax :ACQUIRE:SEGMENTED:INDEX <index>
 <index> ::= an integer from 2 to 2000 in NR1 format

NOTE

This command is available when the segmented memory option (Option SGM) is enabled.

The :ACQUIRE:SEGMENTED:INDEX command sets the index into the memory segments that have been acquired.

The segmented memory acquisition mode is enabled with the :ACQUIRE:MODE command. The number of segments to acquire is set using the :ACQUIRE:SEGMENTED:COUNT command, and data is acquired using the :DIGITIZE, :SINGLE, or :RUN commands. The number of memory segments that have been acquired is returned by the :WAVEFORM:SEGMENTED:COUNT? query. The time tag of the currently indexed memory segment is returned by the :WAVEFORM:SEGMENTED:TTAG? query.

Query Syntax :ACQUIRE:SEGMENTED:INDEX?

The :ACQUIRE:SEGMENTED:INDEX? query returns the current segmented memory index setting.

Return Format <index><NL>
 <index> ::= an integer from 2 to 2000 in NR1 format

- See Also**
- ":ACQUIRE:MODE" on [page 179](#)
 - ":ACQUIRE:SEGMENTED:COUNT" on [page 183](#)
 - ":DIGITIZE" on [page 142](#)
 - ":SINGLE" on [page 168](#)
 - ":RUN" on [page 166](#)
 - ":WAVEFORM:SEGMENTED:COUNT" on [page 593](#)
 - ":WAVEFORM:SEGMENTED:TTAG" on [page 594](#)
 - ":ACQUIRE:SEGMENTED:ANALYZE" on [page 182](#)
 - "Introduction to :ACQUIRE Commands" on [page 173](#)

Example Code ' Segmented memory commands example.

```
' -----  
  
Option Explicit  
  
Public myMgr As VisaComLib.ResourceManager  
Public myScope As VisaComLib.FormattedIO488
```



```

Public varQueryResult As Variant
Public strQueryResult As String

Private Declare Sub Sleep Lib "kernel32" (ByVal dwMilliseconds As Long)

Sub Main()

    On Error GoTo VisaComError

    ' Create the VISA COM I/O resource.
    Set myMgr = New VisaComLib.ResourceManager
    Set myScope = New VisaComLib.FormattedIO488
    Set myScope.IO = myMgr.Open("TCPIP0::130.29.70.228::inst0::INSTR")
    myScope.IO.Clear ' Clear the interface.

    ' Turn on segmented memory acquisition mode.
    myScope.WriteString ":ACquire:MODE SEGmented"
    myScope.WriteString ":ACquire:MODE?"
    strQueryResult = myScope.ReadString
    Debug.Print "Acquisition mode: " + strQueryResult

    ' Set the number of segments to 50.
    myScope.WriteString ":ACquire:SEGmented:COUNT 50"
    myScope.WriteString ":ACquire:SEGmented:COUNT?"
    strQueryResult = myScope.ReadString
    Debug.Print "Acquisition memory segments: " + strQueryResult

    ' If data will be acquired within the IO timeout:
    'myScope.IO.Timeout = 10000
    'myScope.WriteString ":DIGitize"
    'Debug.Print ":DIGitize blocks until all segments acquired."
    'myScope.WriteString ":WAVEform:SEGmented:COUNT?"
    'varQueryResult = myScope.ReadNumber

    ' Or, to poll until the desired number of segments acquired:
    myScope.WriteString ":SINGLE"
    Debug.Print ":SINGLE does not block until all segments acquired."
    Do
        Sleep 100 ' Small wait to prevent excessive queries.
        myScope.WriteString ":WAVEform:SEGmented:COUNT?"
        varQueryResult = myScope.ReadNumber
    Loop Until varQueryResult = 50

    Debug.Print "Number of segments in acquired data: " _
        + FormatNumber(varQueryResult)

    Dim lngSegments As Long
    lngSegments = varQueryResult

    ' For each segment:
    Dim dblTimeTag As Double
    Dim lngI As Long

    For lngI = lngSegments To 1 Step -1

        ' Set the segmented memory index.
        myScope.WriteString ":ACquire:SEGmented:INDEX " + CStr(lngI)

```

5 Commands by Subsystem

```
myScope.WriteString ":ACquire:SEGmented:INDEX?"
strQueryResult = myScope.ReadString
Debug.Print "Acquisition memory segment index: " + strQueryResult

' Display the segment time tag.
myScope.WriteString ":WAVEform:SEGmented:TTAG?"
dblTimeTag = myScope.ReadNumber
Debug.Print "Segment " + CStr(lngI) + " time tag: " _
    + FormatNumber(dblTimeTag, 12)

Next lngI

Exit Sub

VisaComError:
    MsgBox "VISA COM Error:" + vbCrLf + Err.Description

End Sub
```

:ACquire:SRATe

N (see [page 740](#))

Query Syntax :ACquire:SRATe?

The :ACquire:SRATe? query returns the current oscilloscope acquisition sample rate. The sample rate is not directly controllable.

Return Format <sample_rate><NL>

<sample_rate> ::= sample rate in NR3 format

- See Also**
- "[Introduction to :ACquire Commands](#)" on page 173
 - "[:ACquire:POINTs](#)" on page 180

:ACquire:TYPE

C (see page 740)

Command Syntax :ACquire:TYPE <type>

<type> ::= {NORMal | AVERage | HRESolution | PEAK}

The :ACquire:TYPE command selects the type of data acquisition that is to take place. The acquisition types are: NORMal, AVERage, HRESolution, and PEAK.

- The :ACquire:TYPE NORMal command sets the oscilloscope in the normal mode.
- The :ACquire:TYPE AVERage command sets the oscilloscope in the averaging mode. You can set the count by sending the :ACquire:COUNT command followed by the number of averages. In this mode, the value for averages is an integer from 1 to 65536. The COUNT value determines the number of averages that must be acquired.

Setting the :ACquire:TYPE to AVERage automatically sets :ACquire:MODE to ETIME (equivalent time sampling).

The AVERage type is not available when in segmented memory mode (:ACquire:MODE SEGmented).

- The :ACquire:TYPE HRESolution command sets the oscilloscope in the high-resolution mode (also known as *smoothing*). This mode is used to reduce noise at slower sweep speeds where the digitizer samples faster than needed to fill memory for the displayed time range.

For example, if the digitizer samples at 200 MSa/s, but the effective sample rate is 1 MSa/s (because of a slower sweep speed), only 1 out of every 200 samples needs to be stored. Instead of storing one sample (and throwing others away), the 200 samples are averaged together to provide the value for one display point. The slower the sweep speed, the greater the number of samples that are averaged together for each display point.

- The :ACquire:TYPE PEAK command sets the oscilloscope in the peak detect mode. In this mode, :ACquire:COUNT has no meaning.

NOTE

The obsolete command ACquire:TYPE:REALtime is functionally equivalent to sending ACquire:MODE RTIME; TYPE NORMal.

Query Syntax :ACquire:TYPE?

The :ACquire:TYPE? query returns the current acquisition type.

Return Format <acq_type><NL>

<acq_type> ::= {NORM | AVER | HRES | PEAK}

- See Also**
- ["Introduction to :ACQUIRE Commands"](#) on page 173
 - [":ACQUIRE:COUNT"](#) on page 177
 - [":ACQUIRE:MODE"](#) on page 179
 - [":DIGITIZE"](#) on page 142
 - [":WAVEFORM:TYPE"](#) on page 600
 - [":WAVEFORM:PREAmble"](#) on page 590

Example Code

```
' ACQUIRE_TYPE - Sets the acquisition mode, which can be NORMAL,  
' PEAK, or AVERAGE.  
myScope.WriteString ":ACQUIRE:TYPE NORMAL"
```

Example program from the start: ["VISA COM Example in Visual Basic"](#) on page 828

:BUS<n> Commands

Control all oscilloscope functions associated with buses made up of digital channels. See ["Introduction to :BUS<n> Commands"](#) on page 191.

Table 54 :BUS<n> Commands Summary

Command	Query	Options and Query Returns
:BUS<n>:BIT<m> {{0 OFF} {1 ON}} (see page 192)	:BUS<n>:BIT<m>? (see page 192)	{0 1} <n> ::= 1 or 2; an integer in NR1 format <m> ::= 0-15; an integer in NR1 format
:BUS<n>:BITS <channel_list>, {{0 OFF} {1 ON}} (see page 193)	:BUS<n>:BITS? (see page 193)	<channel_list>, {0 1} <channel_list> ::= (@<m>, <m>:<m> ...) where "," is separator and ":" is range <n> ::= 1 or 2; an integer in NR1 format <m> ::= 0-15; an integer in NR1 format
:BUS<n>:CLear (see page 195)	n/a	<n> ::= 1 or 2; an integer in NR1 format
:BUS<n>:DISPlay {{0 OFF} {1 ON}} (see page 196)	:BUS<n>:DISPlay? (see page 196)	{0 1} <n> ::= 1 or 2; an integer in NR1 format
:BUS<n>:LABel <string> (see page 197)	:BUS<n>:LABel? (see page 197)	<string> ::= quoted ASCII string up to 10 characters <n> ::= 1 or 2; an integer in NR1 format
:BUS<n>:MASK <mask> (see page 198)	:BUS<n>:MASK? (see page 198)	<mask> ::= 32-bit integer in decimal, <nondecimal>, or <string> <nondecimal> ::= #Hnn...n where n ::= {0,...,9 A,...,F} for hexadecimal <nondecimal> ::= #Bnn...n where n ::= {0 1} for binary <string> ::= "0xnn...n" where n ::= {0,...,9 A,...,F} for hexadecimal <n> ::= 1 or 2; an integer in NR1 format

**Introduction to
:BUS<n>
Commands**

<n> ::= {1 | 2}

The BUS subsystem commands control the viewing, labeling, and digital channel makeup of two possible buses.

NOTE

These commands are only valid for the MSO models.

Reporting the Setup

Use :BUS<n>? to query setup information for the BUS subsystem.

Return Format

The following is a sample response from the :BUS1? query. In this case, the query was issued following a *RST command.

```
:BUS1:DISP 0;LAB "BUS1";MASK +255
```

:BUS<n>:BIT<m>

N (see [page 740](#))

Command Syntax :BUS<n>:BIT<m> <display>

<display> ::= {{1 | ON} | {0 | OFF}}

<n> ::= An integer, 1 or 2, is attached as a suffix to BUS and defines the bus that is affected by the command.

<m> ::= An integer, 0,...,15, is attached as a suffix to BIT and defines the digital channel that is affected by the command.

The :BUS<n>:BIT<m> command includes or excludes the selected bit as part of the definition for the selected bus. If the parameter is a 1 (ON), the bit is included in the definition. If the parameter is a 0 (OFF), the bit is excluded from the definition. *Note:* BIT0-15 correspond to DIGital0-15.

NOTE

This command is only valid for the MSO models.

Query Syntax :BUS<n>:BIT<m>?

The :BUS<n>:BIT<m>? query returns the value indicating whether the specified bit is included or excluded from the specified bus definition.

Return Format <display><NL>

<display> ::= {0 | 1}

- See Also**
- "[Introduction to :BUS<n> Commands](#)" on page 191
 - "[:BUS<n>:BITS](#)" on page 193
 - "[:BUS<n>:CLEar](#)" on page 195
 - "[:BUS<n>:DISPlay](#)" on page 196
 - "[:BUS<n>:LABel](#)" on page 197
 - "[:BUS<n>:MASK](#)" on page 198

Example Code

```
' Include digital channel 1 in bus 1:
myScope.WriteString ":BUS1:BIT1 ON"
```

:BUS<n>:BITS

N (see [page 740](#))

Command Syntax :BUS<n>:BITS <channel_list>, <display>

<channel_list> ::= (@<m>,<m>:<m>, ...) where commas separate bits and colons define bit ranges.

<m> ::= An integer, 0,...,15, defines a digital channel affected by the command.

<display> ::= {{1 | ON} | {0 | OFF}}

<n> ::= An integer, 1 or 2, is attached as a suffix to BUS and defines the bus that is affected by the command.

The :BUS<n>:BITS command includes or excludes the selected bits in the channel list in the definition of the selected bus. If the parameter is a 1 (ON) then the bits in the channel list are included as part of the selected bus definition. If the parameter is a 0 (OFF) then the bits in the channel list are excluded from the definition of the selected bus.

NOTE

This command is only valid for the MSO models.

Query Syntax :BUS<n>:BITS?

The :BUS<n>:BITS? query returns the definition for the specified bus.

Return Format <channel_list>, <display><NL>

<channel_list> ::= (@<m>,<m>:<m>, ...) where commas separate bits and colons define bit ranges.

<display> ::= {0 | 1}

- See Also**
- ["Introduction to :BUS<n> Commands"](#) on page 191
 - [":BUS<n>:BIT<m>"](#) on page 192
 - [":BUS<n>:CLEar"](#) on page 195
 - [":BUS<n>:DISPlay"](#) on page 196
 - [":BUS<n>:LABel"](#) on page 197
 - [":BUS<n>:MASK"](#) on page 198

Example Code

```
' Include digital channels 1, 2, 4, 5, 6, 7, 8, and 9 in bus 1:
myScope.WriteString ":BUS1:BITS (@1,2,4:9), ON"

' Include digital channels 1, 5, 7, and 9 in bus 1:
myScope.WriteString ":BUS1:BITS (@1,5,7,9), ON"

' Include digital channels 1 through 15 in bus 1:
myScope.WriteString ":BUS1:BITS (@1:15), ON"
```

5 Commands by Subsystem

```
' Include digital channels 1 through 5, 8, and 14 in bus 1:  
myScope.WriteString ":BUS1:BITS (@1:5,8,14), ON"
```

:BUS<n>:CLEAr

N (see [page 740](#))

Command Syntax :BUS<n>:CLEAr

<n> ::= An integer, 1 or 2, is attached as a suffix to BUS and defines the bus that is affected by the command.

The :BUS<n>:CLEAr command excludes all of the digital channels from the selected bus definition.

NOTE

This command is only valid for the MSO models.

-
- See Also**
- ["Introduction to :BUS<n> Commands"](#) on page 191
 - [":BUS<n>:BIT<m>"](#) on page 192
 - [":BUS<n>:BITS"](#) on page 193
 - [":BUS<n>:DISPlay"](#) on page 196
 - [":BUS<n>:LABel"](#) on page 197
 - [":BUS<n>:MASK"](#) on page 198

:BUS<n>:DISPlay

N (see [page 740](#))

Command Syntax :BUS<n>:DISplay <value>
<value> ::= {{1 | ON} | {0 | OFF}}

<n> ::= An integer, 1 or 2, is attached as a suffix to BUS and defines the bus that is affected by the command.

The :BUS<n>:DISPlay command enables or disables the view of the selected bus.

NOTE

This command is only valid for the MSO models.

Query Syntax :BUS<n>:DISPlay?

The :BUS<n>:DISPlay? query returns the display value of the selected bus.

Return Format <value><NL>
<value> ::= {0 | 1}

- See Also**
- ["Introduction to :BUS<n> Commands"](#) on page 191
 - [":BUS<n>:BIT<m>"](#) on page 192
 - [":BUS<n>:BITS"](#) on page 193
 - [":BUS<n>:CLEar"](#) on page 195
 - [":BUS<n>:LABel"](#) on page 197
 - [":BUS<n>:MASK"](#) on page 198

:BUS<n>:LABel

N (see [page 740](#))

Command Syntax :BUS<n>:LABel <quoted_string>

<quoted_string> ::= any series of 10 or less characters as a quoted ASCII string.

<n> ::= An integer, 1 or 2, is attached as a suffix to BUS and defines the bus that is affected by the command.

The :BUS<n>:LABel command sets the bus label to the quoted string. Setting a label for a bus will also result in the name being added to the label list.

NOTE

This command is only valid for the MSO models.

NOTE

Label strings are 10 characters or less, and may contain any commonly used ASCII characters. Labels with more than 10 characters are truncated to 10 characters.

Query Syntax :BUS<n>:LABel?

The :BUS<n>:LABel? query returns the name of the specified bus.

Return Format <quoted_string><NL>

<quoted_string> ::= any series of 10 or less characters as a quoted ASCII string.

- See Also**
- ["Introduction to :BUS<n> Commands"](#) on page 191
 - [":BUS<n>:BIT<m>"](#) on page 192
 - [":BUS<n>:BITS"](#) on page 193
 - [":BUS<n>:CLEar"](#) on page 195
 - [":BUS<n>:DISPlay"](#) on page 196
 - [":BUS<n>:MASK"](#) on page 198
 - [":CHANnel<n>:LABel"](#) on page 217
 - [":DISPlay:LABList"](#) on page 241
 - [":DIGital<n>:LABel"](#) on page 231

Example Code

```
' Set the bus 1 label to "Data":
myScope.WriteString ":BUS1:LABel 'Data'
```

:BUS<n>:MASK

N (see [page 740](#))

Command Syntax :BUS<n>:MASK <mask>

<mask> ::= 32-bit integer in decimal, <nondecimal>, or <string>

<nondecimal> ::= #Hnn...n where n ::= {0,...,9 | A,...,F} for hexadecimal

<nondecimal> ::= #Bnn...n where n ::= {0 | 1} for binary

<string> ::= "0xnn...n" where n ::= {0,...,9 | A,...,F} for hexadecimal

<n> ::= An integer, 1 or 2, is attached as a suffix to BUS and defines the bus that is affected by the command.

The :BUS<n>:MASK command defines the bits included and excluded in the selected bus according to the mask. Set a mask bit to a "1" to include that bit in the selected bus, and set a mask bit to a "0" to exclude it.

NOTE

This command is only valid for the MSO models.

Query Syntax :BUS<n>:MASK?

The :BUS<n>:MASK? query returns the mask value for the specified bus.

Return Format <mask><NL> in decimal format

- See Also**
- ["Introduction to :BUS<n> Commands"](#) on page 191
 - [":BUS<n>:BIT<m>"](#) on page 192
 - [":BUS<n>:BITS"](#) on page 193
 - [":BUS<n>:CLEar"](#) on page 195
 - [":BUS<n>:DISPlay"](#) on page 196
 - [":BUS<n>:LABel"](#) on page 197

:CALibrate Commands

Utility commands for viewing calibration status and for starting the user calibration procedure. See "[Introduction to :CALibrate Commands](#)" on page 199.

Table 55 :CALibrate Commands Summary

Command	Query	Options and Query Returns
n/a	:CALibrate:DATE? (see page 201)	<return value> ::= <day>,<month>,<year>; all in NR1 format
:CALibrate:LABel <string> (see page 202)	:CALibrate:LABel? (see page 202)	<string> ::= quoted ASCII string up to 32 characters
:CALibrate:OUTPut <signal> (see page 203)	:CALibrate:OUTPut? (see page 203)	<signal> ::= {TRIGgers SOURce DSOURce MASK}
:CALibrate:START (see page 204)	n/a	n/a
n/a	:CALibrate:STATus? (see page 205)	<return value> ::= ALL,<status_code>,<status_string> <status_code> ::= an integer status code <status_string> ::= an ASCII status string
n/a	:CALibrate:SWITCh? (see page 206)	{PROTEcted UNPROTEcted}
n/a	:CALibrate:TEMPeratur e? (see page 207)	<return value> ::= degrees C delta since last cal in NR3 format
n/a	:CALibrate:TIME? (see page 208)	<return value> ::= <hours>,<minutes>,<seconds>; all in NR1 format

Introduction to :CALibrate Commands

The CALibrate subsystem provides utility commands for:

- Determining the state of the calibration factor protection switch (CAL PROTECT).
- Saving and querying the calibration label string.
- Reporting the calibration time and date.
- Reporting changes in the temperature since the last calibration.

5 Commands by Subsystem

- Starting the user calibration procedure.

:CALibrate:DATE

N (see [page 740](#))

Query Syntax :CALibrate:DATE?

The :CALibrate:DATE? query returns the date of the last calibration.

Return Format <date><NL>

<date> ::= day,month,year in NR1 format<NL>

See Also • ["Introduction to :CALibrate Commands"](#) on page 199

:CALibrate:LABel

N (see [page 740](#))

Command Syntax :CALibrate:LABel <string>

<string> ::= quoted ASCII string of up to 32 characters in length, not including the quotes

The CALibrate:LABel command saves a string that is up to 32 characters in length into the instrument's non-volatile memory. The string may be used to record calibration dates or other information as needed.

Query Syntax :CALibrate:LABel?

The :CALibrate:LABel? query returns the contents of the calibration label string.

Return Format <string><NL>

<string> ::= unquoted ASCII string of up to 32 characters in length

See Also • ["Introduction to :CALibrate Commands"](#) on page 199

:CALibrate:OUTPut

N (see [page 740](#))

Command Syntax :CALibrate:OUTPut <signal>
 <signal> ::= {TRIGgers | SOURce | DSOurce | MASK}

The CALibrate:OUTPut command sets the signal that is available on the rear panel TRIG OUT BNC:

- TRIGgers – pulse when a trigger event occurs.
- SOURce – raw output of trigger comparator.
- DSOurce – SOURce frequency divided by 8.
- MASK – signal from mask test indicating a success or fail mask test.

Query Syntax :CALibrate:OUTPut?

The :CALibrate:OUTPut query returns the current source of the TRIG OUT BNC signal.

Return Format <signal><NL>
 <signal> ::= {TRIG | SOUR | DSO | MASK}

- See Also**
- ["Introduction to :CALibrate Commands"](#) on page 199
 - [":MTEST:OUTPut"](#) on page 364

:CALibrate:START

N (see [page 740](#))

Command Syntax :CALibrate:START

The CALibrate:START command starts the user calibration procedure.

NOTE

Before starting the user calibration procedure, you must set the rear panel CALIBRATION switch to UNPROTECTED, and you must connect BNC cables from the TRIG OUT connector to the analog channel inputs. See the *User's Guide* for details.

-
- See Also**
- "[Introduction to :CALibrate Commands](#)" on page 199
 - "[:CALibrate:SWITCh](#)" on page 206

:CALibrate:STATus

N (see [page 740](#))

Query Syntax :CALibrate:STATus?

The :CALibrate:STATus? query returns the summary results of the last user calibration procedure.

Return Format <return value><NL>

<return value> ::= ALL,<status_code>,<status_string>

<status_code> ::= an integer status code

<status_string> ::= an ASCII status string

See Also • ["Introduction to :CALibrate Commands"](#) on page 199

:CALibrate:SWITCh

N (see [page 740](#))

Query Syntax :CALibrate:SWITCh?

The :CALibrate:SWITCh? query returns the rear-panel calibration protect (CAL PROTECT) switch state. The value PROTECTED indicates calibration is disabled, and UNPROTECTED indicates calibration is enabled.

Return Format <switch><NL>
<switch> ::= {PROT | UNPR}

See Also • ["Introduction to :CALibrate Commands"](#) on page 199

:CALibrate:TEMPerature

N (see [page 740](#))

Query Syntax :CALibrate:TEMPerature?

The :CALibrate:TEMPerature? query returns the change in temperature since the last user calibration procedure.

Return Format <return value><NL>

<return value> ::= degrees C delta since last cal in NR3 format

See Also • ["Introduction to :CALibrate Commands"](#) on page 199

:CALibrate:TIME

N (see [page 740](#))

Query Syntax :CALibrate:TIME?

The :CALibrate:TIME? query returns the time of the last calibration.

Return Format <date><NL>

<date> ::= hour,minutes,seconds in NR1 format

See Also • ["Introduction to :CALibrate Commands"](#) on page 199

:CHANnel<n> Commands

Control all oscilloscope functions associated with individual analog channels or groups of channels. See ["Introduction to :CHANnel<n> Commands"](#) on page 210.

Table 56 :CHANnel<n> Commands Summary

Command	Query	Options and Query Returns
:CHANnel<n>:BWLimit {0 OFF} {1 ON}} (see page 212)	:CHANnel<n>:BWLimit? (see page 212)	{0 1} <n> ::= 1-2 or 1-4 in NR1 format
:CHANnel<n>:COUpling <coupling> (see page 213)	:CHANnel<n>:COUpling? (see page 213)	<coupling> ::= {AC DC} <n> ::= 1-2 or 1-4 in NR1 format
:CHANnel<n>:DISPlay {0 OFF} {1 ON}} (see page 214)	:CHANnel<n>:DISPlay? (see page 214)	{0 1} <n> ::= 1-2 or 1-4 in NR1 format
:CHANnel<n>:IMPedance <impedance> (see page 215)	:CHANnel<n>:IMPedance? (see page 215)	<impedance> ::= {ONEMeg FIFTy} <n> ::= 1-2 or 1-4 in NR1 format
:CHANnel<n>:INVert {0 OFF} {1 ON}} (see page 216)	:CHANnel<n>:INVert? (see page 216)	{0 1} <n> ::= 1-2 or 1-4 in NR1 format
:CHANnel<n>:LABel <string> (see page 217)	:CHANnel<n>:LABel? (see page 217)	<string> ::= any series of 10 or less ASCII characters enclosed in quotation marks <n> ::= 1-2 or 1-4 in NR1 format
:CHANnel<n>:OFFSet <offset>[suffix] (see page 218)	:CHANnel<n>:OFFSet? (see page 218)	<offset> ::= Vertical offset value in NR3 format [suffix] ::= {V mV} <n> ::= 1-2 or 1-4; in NR1 format
:CHANnel<n>:PROBe <attenuation> (see page 219)	:CHANnel<n>:PROBe? (see page 219)	<attenuation> ::= Probe attenuation ratio in NR3 format <n> ::= 1-2 or 1-4r in NR1 format
n/a	:CHANnel<n>:PROBe:ID? (see page 220)	<probe id> ::= unquoted ASCII string up to 11 characters <n> ::= 1-2 or 1-4 in NR1 format
:CHANnel<n>:PROBe:SKEW <skew_value> (see page 221)	:CHANnel<n>:PROBe:SKEW? (see page 221)	<skew_value> ::= -100 ns to +100 ns in NR3 format <n> ::= 1-2 or 1-4 in NR1 format

Table 56 :CHANnel<n> Commands Summary (continued)

Command	Query	Options and Query Returns
:CHANnel<n>:PROBe:STYPe <signal type> (see page 222)	:CHANnel<n>:PROBe:STYPe? (see page 222)	<signal type> ::= {DIFFerential SINGLE} <n> ::= 1-2 or 1-4 in NR1 format
:CHANnel<n>:PROTection (see page 223)	:CHANnel<n>:PROTection? (see page 223)	{NORM TRIP} <n> ::= 1-2 or 1-4 in NR1 format
:CHANnel<n>:RANge <range>[suffix] (see page 224)	:CHANnel<n>:RANge? (see page 224)	<range> ::= Vertical full-scale range value in NR3 format [suffix] ::= {V mV} <n> ::= 1-2 or 1-4 in NR1 format
:CHANnel<n>:SCALe <scale>[suffix] (see page 225)	:CHANnel<n>:SCALe? (see page 225)	<scale> ::= Vertical units per division value in NR3 format [suffix] ::= {V mV} <n> ::= 1-2 or 1-4 in NR1 format
:CHANnel<n>:UNITs <units> (see page 226)	:CHANnel<n>:UNITs? (see page 226)	<units> ::= {VOLT AMPere} <n> ::= 1-2 or 1-4 in NR1 format
:CHANnel<n>:VERNier {{0 OFF} {1 ON}} (see page 227)	:CHANnel<n>:VERNier? (see page 227)	{0 1} <n> ::= 1-2 or 1-4 in NR1 format

Introduction to :CHANnel<n> Commands

<n> ::= {1 | 2 | 3 | 4} for the four channel oscilloscope models
<n> ::= {1 | 2} for the two channel oscilloscope models

The CHANnel<n> subsystem commands control an analog channel (vertical or Y-axis of the oscilloscope). Channels are independently programmable for all offset, probe, coupling, bandwidth limit, inversion, vernier, and range (scale) functions. The channel number (1, 2, 3, or 4) specified in the command selects the analog channel that is affected by the command.

A label command provides identifying annotations of up to 10 characters.

You can toggle the channel displays on and off with the :CHANnel<n>:DISPlay command as well as with the root level commands :VIEW and :BLANK.

NOTE

The obsolete CHANnel subsystem is supported.

Reporting the Setup

Use :CHANnel1?, :CHANnel2?, :CHANnel3? or :CHANnel4? to query setup information for the CHANnel<n> subsystem.

Return Format

The following are sample responses from the :CHANnel<n>? query. In this case, the query was issued following a *RST command.

```
:CHAN1:RANG +40.0E+00;OFFS +0.00000E+00;COUP DC;IMP ONEM;DISP 1;BWL 0;  
INV 0;LAB "1";UNIT VOLT;PROB +10E+00;PROB:SKEW +0.00E+00;STYP SING
```

:CHANnel<n>:BWLimit

C (see [page 740](#))

Command Syntax :CHANnel<n>:BWLimit <bwlimit>

<bwlimit> ::= {{1 | ON} | {0 | OFF}}

<n> ::= {1 | 2 | 3 | 4} for the four channel oscilloscope models

<n> ::= {1 | 2} for the two channel oscilloscope models

The :CHANnel<n>:BWLimit command controls an internal low-pass filter. When the filter is on, the bandwidth of the specified channel is limited to approximately 25 MHz.

Query Syntax :CHANnel<n>:BWLimit?

The :CHANnel<n>:BWLimit? query returns the current setting of the low-pass filter.

Return Format <bwlimit><NL>

<bwlimit> ::= {1 | 0}

See Also • ["Introduction to :CHANnel<n> Commands"](#) on page 210

:CHANnel<n>:COUPling

C (see [page 740](#))

Command Syntax :CHANnel<n>:COUPling <coupling>

<coupling> ::= {AC | DC}

<n> ::= {1 | 2 | 3 | 4} for the four channel oscilloscope models

<n> ::= {1 | 2} for the two channel oscilloscope models

The :CHANnel<n>:COUPling command selects the input coupling for the specified channel. The coupling for each analog channel can be set to AC or DC.

Query Syntax :CHANnel<n>:COUPling?

The :CHANnel<n>:COUPling? query returns the current coupling for the specified channel.

Return Format <coupling value><NL>

<coupling value> ::= {AC | DC}

See Also • ["Introduction to :CHANnel<n> Commands"](#) on page 210

:CHANnel<n>:DISPlay

C (see [page 740](#))

Command Syntax :CHANnel<n>:DISPlay <display value>
<display value> ::= {{1 | ON} | {0 | OFF}}
<n> ::= {1 | 2 | 3 | 4} for the four channel oscilloscope models
<n> ::= {1 | 2} for the two channel oscilloscope models

The :CHANnel<n>:DISPlay command turns the display of the specified channel on or off.

Query Syntax :CHANnel<n>:DISPlay?

The :CHANnel<n>:DISPlay? query returns the current display setting for the specified channel.

Return Format <display value><NL>
<display value> ::= {1 | 0}

- See Also**
- ["Introduction to :CHANnel<n> Commands"](#) on page 210
 - [":VIEW"](#) on page 172
 - [":BLANK"](#) on page 140
 - [":STATus"](#) on page 169
 - [":POD<n>:DISPlay"](#) on page 380
 - [":DIGital<n>:DISPlay"](#) on page 230

:CHANnel<n>:IMPedance

C (see [page 740](#))

Command Syntax :CHANnel<n>:IMPedance <impedance>

<impedance> ::= {ONEMeg | FIFTy}

<n> ::= {1 | 2 | 3 | 4} for the four channel oscilloscope models

<n> ::= {1 | 2} for the two channel oscilloscope models

The :CHANnel<n>:IMPedance command selects the input impedance setting for the specified analog channel. The legal values for this command are ONEMeg (1 M Ω) and FIFTy (50 Ω).

NOTE

The analog channel input impedance of the 100 MHz bandwidth oscilloscope models is fixed at ONEMeg (1 M Ω).

Query Syntax :CHANnel<n>:IMPedance?

The :CHANnel<n>:IMPedance? query returns the current input impedance setting for the specified channel.

Return Format <impedance value><NL>

<impedance value> ::= {ONEM | FIFT}

See Also • ["Introduction to :CHANnel<n> Commands"](#) on page 210

:CHANnel<n>:INVert

N (see [page 740](#))

Command Syntax :CHANnel<n>:INVert <invert value>

<invert value> ::= {{1 | ON} | {0 | OFF}}

<n> ::= {1 | 2 | 3 | 4} for the four channel oscilloscope models

<n> ::= {1 | 2} for the two channel oscilloscope models

The :CHANnel<n>:INVert command selects whether or not to invert the input signal for the specified channel. The inversion may be 1 (ON/inverted) or 0 (OFF/not inverted).

Query Syntax :CHANnel<n>:INVert?

The :CHANnel<n>:INVert? query returns the current state of the channel inversion.

Return Format <invert value><NL>

<invert value> ::= {0 | 1}

See Also • ["Introduction to :CHANnel<n> Commands"](#) on page 210

:CHANnel<n>:LABel

N (see [page 740](#))

Command Syntax :CHANnel<n>:LABel <string>
 <string> ::= quoted ASCII string
 <n> ::= {1 | 2 | 3 | 4} for the four channel oscilloscope models
 <n> ::= {1 | 2} for the two channel oscilloscope models

NOTE

Label strings are 10 characters or less, and may contain any commonly used ASCII characters. Labels with more than 10 characters are truncated to 10 characters. Lower case characters are converted to upper case.

The :CHANnel<n>:LABel command sets the analog channel label to the string that follows. Setting a label for a channel also adds the name to the label list in non-volatile memory (replacing the oldest label in the list).

Query Syntax :CHANnel<n>:LABel?

The :CHANnel<n>:LABel? query returns the label associated with a particular analog channel.

Return Format <string><NL>
 <string> ::= quoted ASCII string

- See Also**
- ["Introduction to :CHANnel<n> Commands"](#) on page 210
 - [":DISPlay:LABel"](#) on page 240
 - [":DIGital<n>:LABel"](#) on page 231
 - [":DISPlay:LABList"](#) on page 241
 - [":BUS<n>:LABel"](#) on page 197

Example Code

```
' LABEL - This command allows you to write a name (10 characters
' maximum) next to the channel number. It is not necessary, but
' can be useful for organizing the display.
myScope.WriteString ":CHANNEL1:LABEL " "CAL 1" " " ' Label ch1 "CAL 1".
myScope.WriteString ":CHANNEL2:LABEL " "CAL2" " " ' Label ch1 "CAL2".
```

Example program from the start: ["VISA COM Example in Visual Basic"](#) on page 828

:CHANnel<n>:OFFSet

C (see [page 740](#))

Command Syntax :CHANnel<n>:OFFSet <offset> [<suffix>]

<offset> ::= Vertical offset value in NR3 format

<suffix> ::= {V | mV}

<n> ::= {1 | 2 | 3 | 4} for the four channel oscilloscope models

<n> ::= {1 | 2} for the two channel oscilloscope models

The :CHANnel<n>:OFFSet command sets the value that is represented at center screen for the selected channel. The range of legal values varies with the value set by the :CHANnel<n>:RANGe and :CHANnel<n>:SCALE commands. If you set the offset to a value outside of the legal range, the offset value is automatically set to the nearest legal value. Legal values are affected by the probe attenuation setting.

Query Syntax :CHANnel<n>:OFFSet?

The :CHANnel<n>:OFFSet? query returns the current offset value for the selected channel.

Return Format <offset><NL>

<offset> ::= Vertical offset value in NR3 format

- See Also**
- "[Introduction to :CHANnel<n> Commands](#)" on page 210
 - "[:CHANnel<n>:RANGe](#)" on page 224
 - "[:CHANnel<n>:SCALE](#)" on page 225
 - "[:CHANnel<n>:PROBe](#)" on page 219

:CHANnel<n>:PROBe

C (see [page 740](#))

Command Syntax :CHANnel<n>:PROBe <attenuation>

<attenuation> ::= probe attenuation ratio in NR3 format

<n> ::= {1 | 2 | 3 | 4} for the four channel oscilloscope models

<n> ::= {1 | 2} for the two channel oscilloscope models

The obsolete attenuation values X1, X10, X20, X100 are also supported.

The :CHANnel<n>:PROBe command specifies the probe attenuation factor for the selected channel. The probe attenuation factor may be 0.1 to 1000. This command does not change the actual input sensitivity of the oscilloscope. It changes the reference constants for scaling the display factors, for making automatic measurements, and for setting trigger levels.

If an AutoProbe probe is connected to the oscilloscope, the attenuation value cannot be changed from the sensed value. Attempting to set the oscilloscope to an attenuation value other than the sensed value produces an error.

Query Syntax :CHANnel<n>:PROBe?

The :CHANnel<n>:PROBe? query returns the current probe attenuation factor for the selected channel.

Return Format <attenuation><NL>

<attenuation> ::= probe attenuation ratio in NR3 format

- See Also**
- ["Introduction to :CHANnel<n> Commands"](#) on page 210
 - [":CHANnel<n>:RANGe"](#) on page 224
 - [":CHANnel<n>:SCALE"](#) on page 225
 - [":CHANnel<n>:OFFSet"](#) on page 218

Example Code

```
' CHANNEL_PROBE - Sets the probe attenuation factor for the selected
' channel. The probe attenuation factor may be set from 0.1 to 1000.
myScope.WriteString ":CHAN1:PROBE 10" ' Set Probe to 10:1.
```

Example program from the start: ["VISA COM Example in Visual Basic"](#) on page 828

:CHANnel<n>:PROBe:ID

C (see [page 740](#))

Query Syntax :CHANnel<n>:PROBe:ID?

<n> ::= {1 | 2 | 3 | 4} for the four channel oscilloscope models

<n> ::= {1 | 2} for the two channel oscilloscope models

The :CHANnel<n>:PROBe:ID? query returns the type of probe attached to the specified oscilloscope channel.

Return Format <probe id><NL>

<probe id> ::= unquoted ASCII string up to 11 characters

Some of the possible returned values are:

- 1131A
- 1132A
- 1134A
- 1147A
- 1153A
- 1154A
- 1156A
- 1157A
- 1158A
- 1159A
- AutoProbe
- E2621A
- E2622A
- E2695A
- E2697A
- HP1152A
- HP1153A
- NONE
- Probe
- Unknown
- Unsupported

See Also • ["Introduction to :CHANnel<n> Commands"](#) on page 210

:CHANnel<n>:PROBe:SKEW

C (see [page 740](#))

Command Syntax :CHANnel<n>:PROBe:SKEW <skew value>
 <skew value> ::= skew time in NR3 format
 <skew value> ::= -100 ns to +100 ns
 <n> ::= {1 | 2 | 3 | 4}

The :CHANnel<n>:PROBe:SKEW command sets the channel-to-channel skew factor for the specified channel. Each analog channel can be adjusted + or -100 ns for a total of 200 ns difference between channels. You can use the oscilloscope's probe skew control to remove cable-delay errors between channels.

Query Syntax :CHANnel<n>:PROBe:SKEW?

The :CHANnel<n>:PROBe:SKEW? query returns the current probe skew setting for the selected channel.

Return Format <skew value><NL>
 <skew value> ::= skew value in NR3 format

See Also • ["Introduction to :CHANnel<n> Commands"](#) on page 210

:CHANnel<n>:PROBe:STYPe

C (see [page 740](#))

Command Syntax**NOTE**

This command is valid only for the 113xA Series probes.

```
:CHANnel<n>:PROBe:STYPe <signal type>
<signal type> ::= {DIFFerential | SINGle}
<n> ::= {1 | 2 | 3 | 4} for the four channel oscilloscope models
<n> ::= {1 | 2} for the two channel oscilloscope models
```

The :CHANnel<n>:PROBe:STYPe command sets the channel probe signal type (STYPe) to differential or single-ended when using the 113xA Series probes and determines how offset is applied.

When single-ended is selected, the :CHANnel<n>:OFFset command changes the offset value of the probe amplifier. When differential is selected, the :CHANnel<n>:OFFset command changes the offset value of the channel amplifier.

Query Syntax :CHANnel<n>:PROBe:STYPe?

The :CHANnel<n>:PROBe:STYPe? query returns the current probe signal type setting for the selected channel.

Return Format <signal type><NL>

```
<signal type> ::= {DIFF | SING}
```

- See Also**
- "[Introduction to :CHANnel<n> Commands](#)" on page 210
 - "[:CHANnel<n>:OFFSet](#)" on page 218

:CHANnel<n>:PROTection

N (see [page 740](#))

Command Syntax :CHANnel<n>:PROTection[:CLEar]

<n> ::= {1 | 2 | 3 | 4}

When the analog channel input impedance is set to 50Ω (on the 300 MHz, 500 MHz, and 1 GHz bandwidth oscilloscope models), the input channels are protected against overvoltage. When an overvoltage condition is sensed, the input impedance for the channel is automatically changed to 1 MΩ. The :CHANnel<n>:PROTection[:CLEar] command is used to clear (reset) the overload protection. It allows the channel to be used again in 50Ω mode after the signal that caused the overload has been removed from the channel input. Reset the analog channel input impedance to 50Ω (see [":CHANnel<n>:IMPedance"](#) on page 215) after clearing the overvoltage protection.

Query Syntax :CHANnel<n>:PROTection?

The :CHANnel<n>:PROTection query returns the state of the input protection for CHANnel<n>. If a channel input has experienced an overload, TRIP (tripped) will be returned; otherwise NORM (normal) is returned.

Return Format {NORM | TRIP}<NL>

- See Also**
- ["Introduction to :CHANnel<n> Commands"](#) on page 210
 - [":CHANnel<n>:COUPling"](#) on page 213
 - [":CHANnel<n>:IMPedance"](#) on page 215
 - [":CHANnel<n>:PROBe"](#) on page 219

:CHANnel<n>:RANGe

C (see [page 740](#))

Command Syntax :CHANnel<n>:RANGe <range>[<suffix>]

<range> ::= vertical full-scale range value in NR3 format

<suffix> ::= {V | mV}

<n> ::= {1 | 2 | 3 | 4} for the four channel oscilloscope models

<n> ::= {1 | 2} for the two channel oscilloscope models

The :CHANnel<n>:RANGe command defines the full-scale vertical axis of the selected channel. When using 1:1 probe attenuation, the range can be set to any value from:

- 8 mV to 40 V for the 100 MHz models.
- 16 mV to 8 V for the 300 MHz – 1 GHz models with the input impedance set to 50Ω.

If the probe attenuation is changed, the range value is multiplied by the probe attenuation factor.

Query Syntax :CHANnel<n>:RANGe?

The :CHANnel<n>:RANGe? query returns the current full-scale range setting for the specified channel.

Return Format <range_argument><NL>

<range_argument> ::= vertical full-scale range value in NR3 format

- See Also**
- ["Introduction to :CHANnel<n> Commands"](#) on page 210
 - [":CHANnel<n>:SCALE"](#) on page 225
 - [":CHANnel<n>:PROBe"](#) on page 219

Example Code

```
' CHANNEL_RANGE - Sets the full scale vertical range in volts. The
' range value is 8 times the volts per division.
myScope.WriteString ":CHANNEL1:RANGE 8" ' Set the vertical range to
8 volts.
```

Example program from the start: ["VISA COM Example in Visual Basic"](#) on page 828

:CHANnel<n>:SCALE

N (see [page 740](#))

Command Syntax :CHANnel<n>:SCALE <scale>[<suffix>]

<scale> ::= vertical units per division in NR3 format

<suffix> ::= {V | mV}

<n> ::= {1 | 2 | 3 | 4} for the four channel oscilloscope models

<n> ::= {1 | 2} for the two channel oscilloscope models

The :CHANnel<n>:SCALE command sets the vertical scale, or units per division, of the selected channel. When using 1:1 probe attenuation, legal values for the scale range from:

- 1 mV to 5 V for the 100 MHz models.
- 2 mV to 1 V for the 300 MHz – 1 GHz models with the input impedance set to 50Ω

If the probe attenuation is changed, the scale value is multiplied by the probe's attenuation factor.

Query Syntax :CHANnel<n>:SCALE?

The :CHANnel<n>:SCALE? query returns the current scale setting for the specified channel.

Return Format <scale value><NL>

<scale value> ::= vertical units per division in NR3 format

- See Also**
- "[Introduction to :CHANnel<n> Commands](#)" on page 210
 - "[:CHANnel<n>:RANGE](#)" on page 224
 - "[:CHANnel<n>:PROBE](#)" on page 219

:CHANnel<n>:UNITs

N (see [page 740](#))

Command Syntax :CHANnel<n>:UNITs <units>

<units> ::= {VOLT | AMPere}

<n> ::= {1 | 2} for the two channel oscilloscope models

<n> ::= {1 | 2 | 3 | 4} for the four channel oscilloscope models

The :CHANnel<n>:UNITs command sets the measurement units for the connected probe. Select VOLT for a voltage probe and select AMPere for a current probe. Measurement results, channel sensitivity, and trigger level will reflect the measurement units you select.

Query Syntax :CHANnel<n>:UNITs?

The :CHANnel<n>:UNITs? query returns the current units setting for the specified channel.

Return Format <units><NL>

<units> ::= {VOLT | AMP}

- See Also**
- ["Introduction to :CHANnel<n> Commands"](#) on page 210
 - [":CHANnel<n>:RANGe"](#) on page 224
 - [":CHANnel<n>:PROBe"](#) on page 219
 - [":EXTernal:UNITs"](#) on page 254

:CHANnel<n>:VERNier

N (see [page 740](#))

Command Syntax :CHANnel<n>:VERNier <vernier value>

<vernier value> ::= {{1 | ON} | {0 | OFF}}

<n> ::= {1 | 2 | 3 | 4} for the four channel oscilloscope models

<n> ::= {1 | 2} for the two channel oscilloscope models

The :CHANnel<n>:VERNier command specifies whether the channel's vernier (fine vertical adjustment) setting is ON (1) or OFF (0).

Query Syntax :CHANnel<n>:VERNier?

The :CHANnel<n>:VERNier? query returns the current state of the channel's vernier setting.

Return Format <vernier value><NL>

<vernier value> ::= {0 | 1}

See Also • ["Introduction to :CHANnel<n> Commands"](#) on page 210

:DIGital<n> Commands

Control all oscilloscope functions associated with individual digital channels. See "Introduction to :DIGital<n> Commands" on page 228.

Table 57 :DIGital<n> Commands Summary

Command	Query	Options and Query Returns
:DIGital<n>:DISPlay {0 OFF} {1 ON} (see page 230)	:DIGital<n>:DISPlay? (see page 230)	{0 1} <n> ::= 0-15; an integer in NR1 format
:DIGital<n>:LABel <string> (see page 231)	:DIGital<n>:LABel? (see page 231)	<string> ::= any series of 10 or less ASCII characters enclosed in quotation marks <n> ::= 0-15; an integer in NR1 format
:DIGital<n>:POSition <position> (see page 232)	:DIGital<n>:POSition? (see page 232)	<n> ::= 0-15; an integer in NR1 format <position> ::= 0-7 if display size = large, 0-15 if size = medium, 0-31 if size = small
:DIGital<n>:SIZE <value> (see page 233)	:DIGital<n>:SIZE? (see page 233)	<value> ::= {SMALl MEDium LARGe}
:DIGital<n>:THReshold <value>[suffix] (see page 234)	:DIGital<n>:THReshold? (see page 234)	<n> ::= 0-15; an integer in NR1 format <value> ::= {CMOS ECL TTL <user defined value>} <user defined value> ::= value in NR3 format from -8.00 to +8.00 [suffix] ::= {V mV uV}

Introduction to :DIGital<n> Commands

<n> ::= {0, ..., 15}

The DIGital subsystem commands control the viewing, labeling, and positioning of digital channels. They also control threshold settings for groups of digital channels (D0-D7, D8-D15).

NOTE

These commands are only valid for the MSO models.

Reporting the Setup

Use :DIGital<n>? to query setup information for the DIGital subsystem.

Return Format

The following is a sample response from the :DIGital0? query. In this case, the query was issued following a *RST command.

```
:DIG0:DISP 0;THR +1.40E+00;LAB 'D0';POS +0
```

:DIGital<n>:DISPlay

N (see [page 740](#))

Command Syntax :DIGital<n>:DISPlay <display>

<display> ::= {{1 | ON} | {0 | OFF}}

<n> ::= An integer, 0, 1, ..., 15, is attached as a suffix to the command and defines the logic channel that is affected by the command.

The :DIGital<n>:DISPlay command turns digital display on or off for the specified channel.

NOTE

This command is only valid for the MSO models.

Query Syntax :DIGital<n>:DISPlay?

The :DIGital<n>:DISPlay? query returns the current digital display setting for the specified channel.

Return Format <display><NL>

<display> ::= {0 | 1}

- See Also**
- ["Introduction to :DIGital<n> Commands"](#) on page 228
 - [":POD<n>:DISPlay"](#) on page 380
 - [":CHANnel<n>:DISPlay"](#) on page 214
 - [":VIEW"](#) on page 172
 - [":BLANK"](#) on page 140
 - [":STATus"](#) on page 169

:DIGital<n>:LABel

N (see [page 740](#))

Command Syntax :DIGital<n>:LABel <string>

<string> ::= any series of 10 or less characters as quoted ASCII string.

<n> ::= An integer, 0,...,15, is attached as a suffix to the command and defines the logic channel that is affected by the command.

The :DIGital<n>:LABel command sets the channel label to the string that follows. Setting a label for a channel also adds the name to the label list in non-volatile memory (replacing the oldest label in the list).

NOTE

This command is only valid for the MSO models.

NOTE

Label strings are 10 characters or less, and may contain any commonly used ASCII characters. Labels with more than 10 characters are truncated to 10 characters.

Query Syntax :DIGital<n>:LABel?

The :DIGital<n>:LABel? query returns the name of the specified channel.

Return Format <label string><NL>

<label string> ::= any series of 10 or less characters as a quoted ASCII string.

- See Also**
- ["Introduction to :DIGital<n> Commands"](#) on page 228
 - [":CHANnel<n>:LABel"](#) on page 217
 - [":DISPlay:LABList"](#) on page 241
 - [":BUS<n>:LABel"](#) on page 197

:DIGital<n>:POSition

N (see [page 740](#))

Command Syntax :DIGital<n>:POSition <position>

<position> ::= integer in NR1 format.

<n> ::= An integer, 0, 1, ..., 15, is attached as a suffix to the command and defines the logic channel that is affected by the command.

Channel Size	Position	Top	Bottom
Large	0-7	7	0
Medium	0-15	15	0
Small	0-31	31	0

The :DIGital<n>:POSition command sets the position of the specified channel.

NOTE

This command is only valid for the MSO models.

Query Syntax :DIGital<n>:POSition?

The :DIGital<n>:POSition? query returns the position of the specified channel.

Return Format <position><NL>

<position> ::= integer in NR1 format.

See Also • ["Introduction to :DIGital<n> Commands"](#) on page 228

:DIGital<n>:SIZE

N (see [page 740](#))

Command Syntax :DIGital<n>:SIZE <value>

<n> ::= An integer, 0, 1, ..., 15, is attached as a suffix to the command and defines the logic channel that is affected by the command.

<value> ::= {SMALl | MEDium | LARGe}

The :DIGital<n>:SIZE command specifies the size of digital channels on the display. Sizes are set for all digital channels. Therefore, if you set the size on digital channel 0 (for example), the same size is set on channels 1 through 15 as well.

NOTE

This command is only valid for the MSO models.

Query Syntax :DIGital<n>:SIZE?

The :DIGital<n>:SIZE? query returns the size setting for the specified digital channels.

Return Format <size_value><NL>

<size_value> ::= {SMAL | MED | LARG}

- See Also**
- "[Introduction to :DIGital<n> Commands](#)" on page 228
 - "[:POD<n>:SIZE](#)" on page 381
 - "[:DIGital<n>:POSition](#)" on page 232

:DIGital<n>:THReshold

N (see [page 740](#))

Command Syntax :DIGital<n>:THReshold <value>

<value> ::= {CMOS | ECL | TTL | <user defined value>[<suffix>]}

<user defined value> ::= -8.00 to +8.00 in NR3 format

<suffix> ::= {V | mV | uV}

<n> ::= An integer, 0, 1, ..., 15, is attached as a suffix to the command and defines the logic channel that is affected by the command.

- TTL = 1.4V
- CMOS = 2.5V
- ECL = -1.3V

The :DIGital<n>:THReshold command sets the logic threshold value for all channels grouped with the specified channel (D0-D7, D8-D15). The threshold is used for triggering purposes and for displaying the digital data as high (above the threshold) or low (below the threshold).

NOTE

This command is only valid for the MSO models.

Query Syntax :DIGital<n>:THReshold?

The :DIGital<n>:THReshold? query returns the threshold value for the specified channel.

Return Format <value><NL>

<value> ::= threshold value in NR3 format

- See Also**
- "[Introduction to :DIGital<n> Commands](#)" on page 228
 - "[:POD<n>:THReshold](#)" on page 382
 - "[:TRIGger\[:EDGE\]:LEVel](#)" on page 488

:DISPlay Commands

Control how waveforms, graticule, and text are displayed and written on the screen. See "[Introduction to :DISPlay Commands](#)" on page 235.

Table 58 :DISPlay Commands Summary

Command	Query	Options and Query Returns
:DISPlay:CLear (see page 237)	n/a	n/a
:DISPlay:DATA [<format>][,][<area>] [,][<palette>]<display data> (see page 238)	:DISPlay:DATA? [<format>][,][<area>] [,][<palette>] (see page 238)	<format> ::= {TIFF} (command) <area> ::= {GRATicule} (command) <palette> ::= {MONochrome} (command) <format> ::= {TIFF BMP BMP8bit PNG} (query) <area> ::= {GRATicule SCReen} (query) <palette> ::= {MONochrome GRAYscale COLor} (query) <display data> ::= data in IEEE 488.2 # format
:DISPlay:LABel {{0 OFF} {1 ON}} (see page 240)	:DISPlay:LABel? (see page 240)	{0 1}
:DISPlay:LABList <binary block> (see page 241)	:DISPlay:LABList? (see page 241)	<binary block> ::= an ordered list of up to 75 labels, each 10 characters maximum, separated by newline characters
:DISPlay:PERsistence <value> (see page 242)	:DISPlay:PERsistence? (see page 242)	<value> ::= {MINimum INFinite}}
:DISPlay:SOURce <value> (see page 243)	:DISPlay:SOURce? (see page 243)	<value> ::= {PMEMemory{0 1 2 3 4 5 6 7 8 9}}
:DISPlay:VECTors {{1 ON} {0 OFF}} (see page 244)	:DISPlay:VECTors? (see page 244)	{1 0}

Introduction to :DISPlay Commands The DISPlay subsystem is used to control the display storage and retrieval of waveform data, labels, and text. This subsystem allows the following actions:

- Clear the waveform area on the display.
- Turn vectors on or off.

5 Commands by Subsystem

- Set waveform persistence.
- Specify labels.
- Save and Recall display data.

Reporting the Setup

Use :DISPlay? to query the setup information for the DISPlay subsystem.

Return Format

The following is a sample response from the :DISPlay? query. In this case, the query was issued following a *RST command.

```
:DISP:LAB 0;CONN 1;PERS MIN;SOUR PMEM9
```

:DISPlay:CLEAr

N (see [page 740](#))

Command Syntax :DISPlay:CLEAr

The :DISPlay:CLEAr command clears the display and resets all associated measurements. If the oscilloscope is stopped, all currently displayed data is erased. If the oscilloscope is running, all of the data for active channels and functions is erased; however, new data is displayed on the next acquisition.

- See Also**
- "[Introduction to :DISPlay Commands](#)" on page 235
 - "[:CDISplay](#)" on page 141

:DISPlay:DATA

N (see [page 740](#))

Command Syntax :DISPlay:DATA [<format>][,] [<area>][,] [<palette>]<display data>
 <format> ::= {TIFF}
 <area> ::= {GRATicule}
 <palette> ::= {MONochrome}
 <display data> ::= binary block data in IEEE-488.2 # format.

The :DISPlay:DATA command writes trace memory data (a display bitmap) to the display or to one of the trace memories in the instrument.

If a data format or area is specified, the :DISPlay:DATA command transfers the data directly to the display. If neither the data format nor the area is specified, the command transfers data to the trace memory specified by the :DISPlay:SOURce command. Available trace memories are PMEMory0-9 and these memories correspond to the INTERN_0-9 files in the front panel Save/Recall menu.

Graticule data is a low resolution bitmap of the graticule area in TIFF format. This is the same data saved using the front panel Save/Recall menu or the *SAV (Save) command.

Query Syntax :DISPlay:DATA? [<format>][,] [<area>][,] [<palette>]
 <format> ::= {TIFF | BMP | BMP8bit | PNG}
 <area> ::= {GRATicule | SCReen}
 <palette> ::= {MONochrome | GRAYscale | COLor}

The :DISPlay:DATA? query reads display data from the screen or from one of the trace memories in the instrument. The format for the data transmission is the # format defined in the IEEE 488.2 specification.

If a data format or area is specified, the :DISPlay:DATA query transfers the data directly from the display. If neither the data format nor the area is specified, the query transfers data from the trace memory specified by the :DISPlay:SOURce command.

Screen data is the full display and is high resolution in grayscale or color. The :HARDcopy:INKSaver setting also affects the screen data. It may be read from the instrument in 24-bit bmp, 8-bit bmp, or 24-bit png format. This data cannot be sent back to the instrument.

Graticule data is a low resolution bitmap of the graticule area in TIFF format. You can get this data and send it back to the oscilloscope.

NOTE

If the format is TIFF, the only valid value area parameter is GRATICule, and the only valid palette parameter is MONOchrome.

If the format is something other than TIFF, the only valid area parameter is SCReen, and the only valid values for palette are GRAYscale or COLor.

Return Format <display data><NL>

<display data> ::= binary block data in IEEE-488.2 # format.

- See Also**
- ["Introduction to :DISPlay Commands"](#) on page 235
 - [":DISPlay:SOURce"](#) on page 243
 - [":HARDcopy:INKSaver"](#) on page 278
 - [":MERGe"](#) on page 150
 - [":PRINT"](#) on page 165
 - ["*RCL \(Recall\)"](#) on page 119
 - ["*SAV \(Save\)"](#) on page 123
 - [":VIEW"](#) on page 172

Example Code

```
' IMAGE_TRANSFER - In this example, we will query for the image data
' with ":DISPLAY:DATA?", read the data, and then save it to a file.
Dim byteData() As Byte
myScope.IO.Timeout = 15000
myScope.WriteString ":DISPLAY:DATA? BMP, SCREEN, COLOR"
byteData = myScope.ReadIEEEBlock(BinaryType_UI1)
' Output display data to a file:
strPath = "c:\scope\data\screen.bmp"
' Remove file if it exists.
If Len(Dir(strPath)) Then
    Kill strPath
End If
Close #1 ' If #1 is open, close it.
Open strPath For Binary Access Write Lock Write As #1 ' Open file f
or output.
Put #1, , byteData ' Write data.
Close #1 ' Close file.
myScope.IO.Timeout = 5000
```

Example program from the start: ["VISA COM Example in Visual Basic"](#) on page 828

:DISPlay:LABel

N (see [page 740](#))

Command Syntax :DISPlay:LABel <value>
<value> ::= {{1 | ON} | {0 | OFF}}

The :DISPlay:LABel command turns the analog and digital channel labels on and off.

Query Syntax :DISPlay:LABel?

The :DISPlay:LABel? query returns the display mode of the analog and digital labels.

Return Format <value><NL>
<value> ::= {0 | 1}

- See Also**
- ["Introduction to :DISPlay Commands"](#) on page 235
 - [":CHANnel<n>:LABel"](#) on page 217

Example Code

```
' DISP_LABEL (not executed in this example)
' - Turns label names ON or OFF on the analyzer display.
myScope.WriteString ":DISPLAY:LABEL ON" ' Turn on labels.
```

Example program from the start: ["VISA COM Example in Visual Basic"](#) on page 828

:DISPlay:LABList

N (see [page 740](#))

Command Syntax :DISPlay:LABList <binary block data>

<binary block> ::= an ordered list of up to 75 labels, a maximum of 10 characters each, separated by newline characters.

The :DISPlay:LABList command adds labels to the label list. Labels are added in alphabetical order.

NOTE

Labels that begin with the same alphabetic base string followed by decimal digits are considered duplicate labels. Duplicate labels are not added to the label list. For example, if label "A0" is in the list and you try to add a new label called "A123456789", the new label is not added.

Query Syntax :DISPlay:LABList?

The :DISPlay:LABList? query returns the label list.

Return Format <binary block><NL>

<binary block> ::= an ordered list of up to 75 labels, a maximum of 10 characters each, separated by newline characters.

- See Also**
- ["Introduction to :DISPlay Commands"](#) on page 235
 - [":DISPlay:LABel"](#) on page 240
 - [":CHANnel<n>:LABel"](#) on page 217
 - [":DIGital<n>:LABel"](#) on page 231
 - [":BUS<n>:LABel"](#) on page 197

:DISPlay:PERStence

N (see [page 740](#))

Command Syntax :DISPlay:PERStence <value>
<value> ::= {MINimum | INFinite}

The :DISPlay:PERStence command specifies the persistence setting. MINimum indicates zero persistence and INFinite indicates infinite persistence. Use the :DISPlay:CLEar or :CDISplay root command to erase points stored by infinite persistence.

Query Syntax :DISPlay:PERStence?

The :DISPlay:PERStence? query returns the specified persistence value.

Return Format <value><NL>
<value> ::= {MIN | INF}

- See Also**
- "[Introduction to :DISPlay Commands](#)" on page 235
 - "[:DISPlay:CLEar](#)" on page 237
 - "[:CDISplay](#)" on page 141

:DISPlay:SOURce

N (see [page 740](#))

Command Syntax :DISPlay:SOURce <value>

```
<value> ::= {PMEMory0 | PMEMory1 | PMEMory2 | PMEMory3 | PMEMory4
            | PMEMory5 | PMEMory6 | PMEMory7 | PMEMory8 | PMEMory9}
```

```
PMEMory0-9 ::= pixel memory 0 through 9
```

The :DISPlay:SOURce command specifies the default source and destination for the :DISPlay:DATA command and query. PMEMory0-9 correspond to the INTERN_0-9 files found in the front panel Save/Recall menu.

Query Syntax :DISPlay:SOURce?

The :DISPlay:SOURce? query returns the specified SOURCE.

Return Format <value><NL>

```
<value> ::= {PMEM0 | PMEM1 | PMEM2 | PMEM3 | PMEM4 | PMEM5 | PMEM6
            | PMEM7 | PMEM8 | PMEM9}
```

- See Also**
- ["Introduction to :DISPlay Commands"](#) on page 235
 - [":DISPlay:DATA"](#) on page 238

:DISPlay:VECTors

N (see [page 740](#))

Command Syntax :DISPlay:VECTors <vectors>

<vectors> ::= {{1 | ON} | {0 | OFF}}

The :DISPlay:VECTors command turns vector display on or off. When vectors are turned on, the oscilloscope displays lines connecting sampled data points. When vectors are turned off, only the sampled data is displayed.

Query Syntax :DISPlay:VECTors?

The :DISPlay:VECTors? query returns whether vector display is on or off.

Return Format <vectors><NL>

<vectors> ::= {1 | 0}

See Also • ["Introduction to :DISPlay Commands"](#) on page 235

:EXternal Trigger Commands

Control the input characteristics of the external trigger input. See "[Introduction to :EXternal Trigger Commands](#)" on page 245.

Table 59 :EXternal Trigger Commands Summary

Command	Query	Options and Query Returns
:EXternal:BWLimit <bwlimit> (see page 247)	:EXternal:BWLimit? (see page 247)	<bwlimit> ::= {0 OFF}
:EXternal:IMPedance <value> (see page 248)	:EXternal:IMPedance? (see page 248)	<impedance> ::= {ONEMeg FIFTy}
:EXternal:PROBe <attenuation> (see page 249)	:EXternal:PROBe? (see page 249)	<attenuation> ::= probe attenuation ratio in NR3 format
n/a	:EXternal:PROBe:ID? (see page 250)	<probe id> ::= unquoted ASCII string up to 11 characters
:EXternal:PROBe:STYPe <signal type> (see page 251)	:EXternal:PROBe:STYPe? (see page 251)	<signal type> ::= {DIFFerential SINGle}
:EXternal:PROTection[:CLEar] (see page 252)	:EXternal:PROTection? (see page 252)	{NORM TRIP}
:EXternal:RANGe <range>[<suffix>] (see page 253)	:EXternal:RANGe? (see page 253)	<range> ::= vertical full-scale range value in NR3 format <suffix> ::= {V mV}
:EXternal:UNITs <units> (see page 254)	:EXternal:UNITs? (see page 254)	<units> ::= {VOLT AMPere}

Introduction to :EXternal Trigger Commands The EXternal trigger subsystem commands control the input characteristics of the external trigger input. The probe factor, impedance, input range, input protection state, units, and bandwidth limit settings may all be queried. Depending on the instrument type, some settings may be changeable.

Reporting the Setup

Use :EXternal? to query setup information for the EXternal subsystem.

Return Format

5 Commands by Subsystem

The following is a sample response from the :EXTERNAL query. In this case, the query was issued following a *RST command.

```
:EXT:BWL 0;IMP ONEM;RANG +8.0E+00;UNIT VOLT;PROB +1.0E+00;PROB:STYP SING
```

:EXternal:BWLimit

C (see [page 740](#))

Command Syntax :EXternal:BWLimit <bwlimit>

<bwlimit> ::= {0 | OFF}

The :EXternal:BWLimit command is provided for product compatibility. The only legal value is 0 or OFF. Use the :TRIGger:HFReject command to limit bandwidth on the external trigger input.

Query Syntax :EXternal:BWLimit?

The :EXternal:BWLimit? query returns the current setting of the low-pass filter (always 0).

Return Format <bwlimit><NL>

<bwlimit> ::= 0

- See Also**
- ["Introduction to :EXternal Trigger Commands"](#) on page 245
 - ["Introduction to :TRIGger Commands"](#) on page 454
 - [":TRIGger:HFReject"](#) on page 458

:EXternal:IMPedance

C (see [page 740](#))

Command Syntax :EXternal:IMPedance <value>
<value> ::= {ONEMeg | FIFTy}

The :EXternal:IMPedance command selects the input impedance setting for the external trigger. The legal values for this command are ONEMeg (1 M Ω) and FIFTy (50 Ω).

NOTE

You can set external trigger input impedance to FIFTy (50 Ω) on the 2-channel, 300 MHz, 500 MHz, and 1 GHz bandwidth oscilloscope models.

Query Syntax :EXternal:IMPedance?

The :EXternal:IMPedance? query returns the current input impedance setting for the external trigger.

Return Format <impedance value><NL>
<impedance value> ::= {ONEM | FIFT}

- See Also**
- ["Introduction to :EXternal Trigger Commands"](#) on page 245
 - ["Introduction to :TRIGger Commands"](#) on page 454
 - [":CHANnel<n>:IMPedance"](#) on page 215

:EXtErnal:PROBe

C (see [page 740](#))

Command Syntax :EXtErnal:PROBe <attenuation>

<attenuation> ::= probe attenuation ratio in NR3 format

The :EXtErnal:PROBe command specifies the probe attenuation factor for the external trigger. The probe attenuation factor may be 0.1 to 1000. This command does not change the actual input sensitivity of the oscilloscope. It changes the reference constants for scaling the display factors and for setting trigger levels.

If an AutoProbe probe is connected to the oscilloscope, the attenuation value cannot be changed from the sensed value. Attempting to set the oscilloscope to an attenuation value other than the sensed value produces an error.

Query Syntax :EXtErnal:PROBe?

The :EXtErnal:PROBe? query returns the current probe attenuation factor for the external trigger.

Return Format <attenuation><NL>

<attenuation> ::= probe attenuation ratio in NR3 format

- See Also**
- ["Introduction to :EXtErnal Trigger Commands"](#) on page 245
 - [":EXtErnal:RANGe"](#) on page 253
 - ["Introduction to :TRIGger Commands"](#) on page 454
 - [":CHANnel<n>:PROBe"](#) on page 219

:EXternal:PROBe:ID

C (see [page 740](#))

Query Syntax :EXternal:PROBe:ID?

The :EXternal:PROBe:ID? query returns the type of probe attached to the external trigger input.

Return Format <probe id><NL>

<probe id> ::= unquoted ASCII string up to 11 characters

Some of the possible returned values are:

- 1131A
- 1132A
- 1134A
- 1147A
- 1153A
- 1154A
- 1156A
- 1157A
- 1158A
- 1159A
- AutoProbe
- E2621A
- E2622A
- E2695A
- E2697A
- HP1152A
- HP1153A
- NONE
- Probe
- Unknown
- Unsupported

See Also • ["Introduction to :EXternal Trigger Commands"](#) on page 245

:EXtErnal:PROBe:STYPe

C (see [page 740](#))

Command Syntax**NOTE**

This command is valid only for the 113xA Series probes.

```
:EXtErnal:PROBe:STYPe <signal type>
<signal type> ::= {DIFFerential | SINGle}
```

The :EXtErnal:PROBe:STYPe command sets the external trigger probe signal type (STYPe) to differential or single-ended when using the 113xA Series probes and determines how offset is applied.

Query Syntax :EXtErnal:PROBe:STYPe?

The :EXtErnal:PROBe:STYPe? query returns the current probe signal type setting for the external trigger.

Return Format <signal type><NL>

```
<signal type> ::= {DIFF | SING}
```

See Also • ["Introduction to :EXtErnal Trigger Commands"](#) on page 245

:EXternal:PROtection

N (see [page 740](#))

Command Syntax :EXternal:PROtection[:CLEar]

When the external trigger input impedance is set to 50Ω (on the 2-channel, 300 MHz, 500 MHz, and 1 GHz bandwidth oscilloscope models), the external trigger input is protected against overvoltage. When an overvoltage condition is sensed, the input impedance for the external trigger is automatically changed to 1 MΩ. The :EXternal:PROtection[:CLEar] command is used to clear (reset) the overload protection. It allows the external trigger to be used again in 50Ω mode after the signal that caused the overload has been removed from the external trigger input. Reset the external trigger input impedance to 50Ω (see "[:EXternal:IMPedance](#)" on page 248) after clearing the overvoltage protection.

Query Syntax :EXternal:PROtection?

The :EXternal:PROtection query returns the state of the input protection for external trigger. If the external trigger input has experienced an overload, TRIP (tripped) will be returned; otherwise NORM (normal) is returned.

Return Format {NORM | TRIP}<NL>

- See Also**
- "[Introduction to :EXternal Trigger Commands](#)" on page 245
 - "[:EXternal:IMPedance](#)" on page 248
 - "[:EXternal:PROBe](#)" on page 249

:EXtErnal:RANGe

C (see [page 740](#))

Command Syntax :EXtErnal:RANGe <range>[<suffix>]

<range> ::= vertical full-scale range value in NR3 format

<suffix> ::= {V | mV}

The :EXtErnal:RANGe command is provided for product compatibility. When using 1:1 probe attenuation:

- In 2-channel models, the range can be set to 1.0 V or 8.0 V.
- In 4-channel models, the range can only be set to 5.0 V.

If the probe attenuation is changed, the range value is multiplied by the probe attenuation factor.

Query Syntax :EXtErnal:RANGe?

The :EXtErnal:RANGe? query returns the current full-scale range setting for the external trigger.

Return Format <range_argument><NL>

<range_argument> ::= external trigger range value in NR3 format

- See Also**
- ["Introduction to :EXtErnal Trigger Commands"](#) on page 245
 - [":EXtErnal:PROBe"](#) on page 249
 - ["Introduction to :TRIGger Commands"](#) on page 454

:EXtErnal:UNITs

N (see [page 740](#))

Command Syntax :EXtErnal:UNITs <units>
<units> ::= {VOLT | AMPere}

The :EXtErnal:UNITs command sets the measurement units for the probe connected to the external trigger input. Select VOLT for a voltage probe and select AMPere for a current probe. Measurement results, channel sensitivity, and trigger level will reflect the measurement units you select.

Query Syntax :EXtErnal:UNITs?

The :CHANnel<n>:UNITs? query returns the current units setting for the external trigger.

Return Format <units><NL>
<units> ::= {VOLT | AMP}

- See Also**
- ["Introduction to :EXtErnal Trigger Commands"](#) on page 245
 - ["Introduction to :TRIGger Commands"](#) on page 454
 - [":EXtErnal:RANGe"](#) on page 253
 - [":EXtErnal:PROBe"](#) on page 249
 - [":CHANnel<n>:UNITs"](#) on page 226

:FUNCTION Commands

Control functions in the measurement/storage module. See "Introduction to :FUNCTION Commands" on page 257.

Table 60 :FUNCTION Commands Summary

Command	Query	Options and Query Returns
:FUNCTION:CENTer <frequency> (see page 258)	:FUNCTION:CENTer? (see page 258)	<frequency> ::= the current center frequency in NR3 format. The range of legal values is from 0 Hz to 25 GHz.
:FUNCTION:DISPlay {{0 OFF} {1 ON}} (see page 259)	:FUNCTION:DISPlay? (see page 259)	{0 1}
:FUNCTION:GOFT:OPERat ion <operation> (see page 260)	:FUNCTION:GOFT:OPERat ion? (see page 260)	<operation> ::= {ADD SUBTract MULTiply}
:FUNCTION:GOFT:SOURce 1 <source> (see page 261)	:FUNCTION:GOFT:SOURce 1? (see page 261)	<source> ::= CHANnel<n> <n> ::= {1 2 3 4} for 4ch models <n> ::= {1 2} for 2ch models
:FUNCTION:GOFT:SOURce 2 <source> (see page 262)	:FUNCTION:GOFT:SOURce 2? (see page 262)	<source> ::= CHANnel<n> <n> ::= {{1 2} {3 4}} for 4ch models, depending on SOURce1 selection <n> ::= {1 2} for 2ch models
:FUNCTION:OFFSet <offset> (see page 263)	:FUNCTION:OFFSet? (see page 263)	<offset> ::= the value at center screen in NR3 format. The range of legal values is +/-10 times the current sensitivity of the selected function.
:FUNCTION:OPERation <operation> (see page 264)	:FUNCTION:OPERation? (see page 264)	<operation> ::= {ADD SUBTract MULTiply INTegrate DIFFerentiate FFT SQRT}

Table 60 :FUNCTION Commands Summary (continued)

Command	Query	Options and Query Returns
:FUNCTION:RANGE <range> (see page 265)	:FUNCTION:RANGE? (see page 265)	<range> ::= the full-scale vertical axis value in NR3 format. The range for ADD, SUBT, MULT is 8E-6 to 800E+3. The range for the INTEGRATE function is 8E-9 to 400E+3. The range for the DIFFERENTIATE function is 80E-3 to 8.0E12 (depends on current sweep speed). The range for the FFT function is 8 to 800 dBV.
:FUNCTION:REFERENCE <level> (see page 266)	:FUNCTION:REFERENCE? (see page 266)	<level> ::= the value at center screen in NR3 format. The range of legal values is +/-10 times the current sensitivity of the selected function.
:FUNCTION:SCALE <scale value>[<suffix>] (see page 267)	:FUNCTION:SCALE? (see page 267)	<scale value> ::= integer in NR1 format <suffix> ::= {V dB}
:FUNCTION:SOURCE1 <source> (see page 268)	:FUNCTION:SOURCE1? (see page 268)	<source> ::= {CHANNEL<n> GOFT} <n> ::= {1 2 3 4} for 4ch models <n> ::= {1 2} for 2ch models GOFT is only for FFT, INTEGRATE, DIFFERENTIATE, and SQRT operations.
:FUNCTION:SOURCE2 <source> (see page 269)	:FUNCTION:SOURCE2? (see page 269)	<source> ::= {CHANNEL<n> NONE} <n> ::= {{1 2} {3 4}} for 4ch models, depending on SOURCE1 selection <n> ::= {1 2} for 2ch models
:FUNCTION:SPAN (see page 270)	:FUNCTION:SPAN? (see page 270)	 ::= the current frequency span in NR3 format. Legal values are 1 Hz to 100 GHz.
:FUNCTION:WINDOW <window> (see page 271)	:FUNCTION:WINDOW? (see page 271)	<window> ::= {RECTANGULAR HANNING FLATTOP BHARRIS}

Introduction to :FUNCTION Commands The FUNCTION subsystem controls the math functions in the oscilloscope. Add, subtract, multiply, differentiate, integrate, square root, and FFT (Fast Fourier Transform) operations are available. These math operations only use the analog (vertical) channels.

The SOURce1, DISPlay, RANGE, and OFFSet commands apply to any function. The SPAN, CENTER, and WINDow commands are only useful for FFT functions. When FFT is selected, the cursors change from volts and time to decibels (dB) and frequency (Hz).

Reporting the Setup

Use :FUNCTION? to query setup information for the FUNCTION subsystem.

Return Format

The following is a sample response from the :FUNCTION? queries. In this case, the query was issued following a *RST command.

```
:FUNC:OPER ADD;DISP 0;SOUR1 CHAN1;SOUR2 CHAN2;RANG +8.00E+00;OFFS
+0.0E+00;:FUNC:GOFT:OPER ADD;SOUR1 CHAN1;SOUR2 CHAN2
```

:FUNCTION:CENTer

N (see [page 740](#))

Command Syntax :FUNCTION:CENTer <frequency>

<frequency> ::= the current center frequency in NR3 format. The range of legal values is from 0 Hz to 25 GHz.

The :FUNCTION:CENTer command sets the center frequency when FFT (Fast Fourier Transform) is selected.

Query Syntax :FUNCTION:CENTer?

The :FUNCTION:CENTer? query returns the current center frequency in Hertz.

Return Format <frequency><NL>

<frequency> ::= the current center frequency in NR3 format. The range of legal values is from 0 Hz to 25 GHz.

NOTE

After a *RST (Reset) or :AUToscale command, the values returned by the :FUNCTION:CENTer? and :FUNCTION:SPAN? queries depend on the current :TIMEbase:RANGe value. Once you change either the :FUNCTION:CENTer or :FUNCTION:SPAN value, they no longer track the :TIMEbase:RANGe value.

- See Also**
- "[Introduction to :FUNCTION Commands](#)" on page 257
 - "[:FUNCTION:SPAN](#)" on page 270
 - "[:TIMEbase:RANGe](#)" on page 446
 - "[:TIMEbase:SCALE](#)" on page 449

:FUNCTION:DISPlay

N (see [page 740](#))

Command Syntax :FUNCTION:DISPlay <display>
 <display> ::= {{1 | ON} | {0 | OFF}}

The :FUNCTION:DISPlay command turns the display of the function on or off. When ON is selected, the function performs as specified using the other FUNCTION commands. When OFF is selected, function is neither calculated nor displayed.

Query Syntax :FUNCTION:DISPlay?

The :FUNCTION:DISPlay? query returns whether the function display is on or off.

Return Format <display><NL>
 <display> ::= {1 | 0}

- See Also**
- ["Introduction to :FUNCTION Commands"](#) on page 257
 - [":VIEW"](#) on page 172
 - [":BLANK"](#) on page 140
 - [":STATus"](#) on page 169

:FUNCTION:GOFT:OPERation

N (see [page 740](#))

Command Syntax :FUNCTION:GOFT:OPERation <operation>

<operation> ::= {ADD | SUBTract | MULTiPLY}

The :FUNCTION:GOFT:OPERation command sets the math operation for the g(t) source that can be used as the input to the FFT, INTegrate, DIFFerentiate, or SQRT functions:

- ADD – Source1 + source2.
- SUBTract – Source1 - source2.
- MULTiPLY – Source1 * source2.

The :FUNCTION:GOFT:SOURce1 and :FUNCTION:GOFT:SOURce2 commands are used to select source1 and source2.

Query Syntax :FUNCTION:GOFT:OPERation?

The :FUNCTION:GOFT:OPERation? query returns the current g(t) source operation setting.

Return Format <operation><NL>

<operation> ::= {ADD | SUBT | MULT}

- See Also**
- ["Introduction to :FUNCTION Commands"](#) on page 257
 - [":FUNCTION:GOFT:SOURce1"](#) on page 261
 - [":FUNCTION:GOFT:SOURce2"](#) on page 262
 - [":FUNCTION:SOURce1"](#) on page 268

:FUNCTION:GOFT:SOURce1

N (see [page 740](#))

Command Syntax :FUNCTION:GOFT:SOURce1 <value>
 <value> ::= CHANnel<n>
 <n> ::= {1 | 2 | 3 | 4} for 4ch models
 <n> ::= {1 | 2} for 2ch models

The :FUNCTION:GOFT:SOURce1 command selects the first input channel for the g(t) source that can be used as the input to the FFT, INTEGRate, DIFFerentiate, or SQRT functions.

Query Syntax :FUNCTION:GOFT:SOURce1?

The :FUNCTION:GOFT:SOURce1? query returns the current selection for the first input channel for the g(t) source.

Return Format <value><NL>
 <value> ::= CHAN<n>
 <n> ::= {1 | 2 | 3 | 4} for the 4ch models
 <n> ::= {1 | 2} for the 2ch models

- See Also**
- ["Introduction to :FUNCTION Commands"](#) on page 257
 - [":FUNCTION:GOFT:SOURce2"](#) on page 262
 - [":FUNCTION:GOFT:OPERation"](#) on page 260

:FUNCTION:GOFT:SOURce2

N (see [page 740](#))

Command Syntax :FUNCTION:GOFT:SOURce2 <value>

<value> ::= CHANnel<n>

<n> ::= {{1 | 2} | {3 | 4}} for 4ch models, depending on SOURce1 selection

<n> ::= {1 | 2} for 2ch models

The :FUNCTION:GOFT:SOURce2 command selects the second input channel for the g(t) source that can be used as the input to the FFT, INTegrate, DIFFerentiate, or SQRT functions.

If CHANnel1 or CHANnel2 is selected for :FUNCTION:GOFT:SOURce1, the SOURce2 selection can be CHANnel1 or CHANnel2. Likewise, if CHANnel3 or CHANnel4 is selected for :FUNCTION:GOFT:SOURce1, the SOURce2 selection can be CHANnel3 or CHANnel4.

Query Syntax :FUNCTION:GOFT:SOURce2?

The :FUNCTION:GOFT:SOURce2? query returns the current selection for the second input channel for the g(t) source.

Return Format <value><NL>

<value> ::= CHAN<n>

<n> ::= {{1 | 2} | {3 | 4}} for 4ch models, depending on SOURce1 selection

<n> ::= {1 | 2} for 2ch models

- See Also**
- ["Introduction to :FUNCTION Commands"](#) on page 257
 - [":FUNCTION:GOFT:SOURce1"](#) on page 261
 - [":FUNCTION:GOFT:OPERation"](#) on page 260

:FUNCTION:OFFSet

N (see [page 740](#))

Command Syntax :FUNCTION:OFFSet <offset>

<offset> ::= the value at center screen in NR3 format.

The :FUNCTION:OFFSet command sets the voltage or vertical value represented at center screen for the selected function. The range of legal values is generally +/- 10 times the current scale of the selected function, but will vary by function. If you set the offset to a value outside of the legal range, the offset value is automatically set to the nearest legal value.

NOTE

The :FUNCTION:OFFSet command is equivalent to the :FUNCTION:REFerence command.

Query Syntax :FUNCTION:OFFSet?

The :FUNCTION:OFFSet? query outputs the current offset value for the selected function.

Return Format <offset><NL>

<offset> ::= the value at center screen in NR3 format.

- See Also**
- ["Introduction to :FUNCTION Commands"](#) on page 257
 - [":FUNCTION:RANGE"](#) on page 265
 - [":FUNCTION:REFerence"](#) on page 266
 - [":FUNCTION:SCALE"](#) on page 267

:FUNCTION:OPERation

N (see [page 740](#))

Command Syntax :FUNCTION:OPERation <operation>
 <operation> ::= {ADD | SUBTract | MULTiPLY | INTegrate | DIFFerentiate
 | FFT | SQRT}

The :FUNCTION:OPERation command sets the desired waveform math operation:

- ADD – Source1 + source2.
- SUBTract – Source1 - source2.
- MULTiPLY – Source1 * source2.
- INTegrate – Integrate the selected waveform source.
- DIFFerentiate – Differentiate the selected waveform source.
- FFT – Fast Fourier Transform on the selected waveform source.
- SQRT – Square root on the selected waveform source.

When the operation is ADD, SUBTract, or MULTiPLY, the :FUNCTION:SOURce1 and :FUNCTION:SOURce2 commands are used to select source1 and source2. For all other operations, the :FUNCTION:SOURce1 command selects the waveform source.

Query Syntax :FUNCTION:OPERation?

The :FUNCTION:OPERation? query returns the current operation for the selected function.

Return Format <operation><NL>
 <operation> ::= {ADD | SUBT | MULT | INT | DIFF | FFT | SQRT}

- See Also**
- ["Introduction to :FUNCTION Commands"](#) on page 257
 - [":FUNCTION:SOURce1"](#) on page 268
 - [":FUNCTION:SOURce2"](#) on page 269

:FUNCTION:RANGe

N (see [page 740](#))

Command Syntax :FUNCTION:RANGe <range>

<range> ::= the full-scale vertical axis value in NR3 format.

The :FUNCTION:RANGe command defines the full-scale vertical axis for the selected function.

Query Syntax :FUNCTION:RANGe?

The :FUNCTION:RANGe? query returns the current full-scale range value for the selected function.

Return Format <range><NL>

<range> ::= the full-scale vertical axis value in NR3 format.

The range for ADD, SUBT, MULT is 8E-6 to 800E+3.

The range for the INTegrate function is 8E-9 to 400E+3 (depends on sweep speed).

The range for the DIFFerentiate function is 80E-3 to 8.0E12 (depends on sweep speed).

The range for the FFT (Fast Fourier Transform) function is 8 to 800 dBV.

- See Also**
- "Introduction to :FUNCTION Commands" on page 257
 - ":FUNCTION:SCALE" on page 267

:FUNCTION:REFERENCE

N (see [page 740](#))

Command Syntax :FUNCTION:REFERENCE <level>

<level> ::= the current reference level in NR3 format.

The :FUNCTION:REFERENCE command sets the voltage or vertical value represented at center screen for the selected function. The range of legal values is generally +/- 10 times the current scale of the selected function, but will vary by function. If you set the reference level to a value outside of the legal range, the level is automatically set to the nearest legal value.

NOTE

The FUNCTION:REFERENCE command is equivalent to the :FUNCTION:OFFSET command.

Query Syntax :FUNCTION:REFERENCE?

The :FUNCTION:REFERENCE? query outputs the current reference level value for the selected function.

Return Format <level><NL>

<level> ::= the current reference level in NR3 format.

- See Also**
- ["Introduction to :FUNCTION Commands"](#) on page 257
 - [":FUNCTION:OFFSET"](#) on page 263
 - [":FUNCTION:RANGE"](#) on page 265
 - [":FUNCTION:SCALE"](#) on page 267

:FUNCTION:SCALE

N (see [page 740](#))

Command Syntax :FUNCTION:SCALE <scale value>[<suffix>]
 <scale value> ::= integer in NR1 format
 <suffix> ::= {V | dB}

The :FUNCTION:SCALE command sets the vertical scale, or units per division, of the selected function. Legal values for the scale depend on the selected function.

Query Syntax :FUNCTION:SCALE?

The :FUNCTION:SCALE? query returns the current scale value for the selected function.

Return Format <scale value><NL>
 <scale value> ::= integer in NR1 format

- See Also**
- ["Introduction to :FUNCTION Commands"](#) on page 257
 - [":FUNCTION:RANGE"](#) on page 265

:FUNCTION:SOURce1

N (see [page 740](#))

Command Syntax :FUNCTION:SOURce1 <value>
 <value> ::= {CHANnel<n> | GOFT}
 <n> ::= {1 | 2 | 3 | 4} for 4ch models
 <n> ::= {1 | 2} for 2ch models

The :FUNCTION:SOURce1 command is used for any :FUNCTION:OPERation selection (including the ADD, SUBTract, or MULTiPLY channel math operations and the FFT, INTegrate, DIFFerentiate, or SQRT transforms). This command selects the first source for channel math operations or the single source for the transforms.

The GOFT parameter is only available for the FFT, INTegrate, DIFFerentiate, or SQRT functions. It lets you specify, as the function input source, the addition, subtraction, or multiplication of two channels. When GOFT is used, the g(t) source is specified by the :FUNCTION:GOFT:OPERation, :FUNCTION:GOFT:SOURce1, and :FUNCTION:GOFT:SOURce2 commands.

NOTE

Another shorthand notation for SOURce1 in this command/query (besides SOUR1) is SOUR.

Query Syntax :FUNCTION:SOURce1?

The :FUNCTION:SOURce1? query returns the current source1 for function operations.

Return Format <value><NL>
 <value> ::= {CHAN<n> | GOFT}
 <n> ::= {1 | 2 | 3 | 4} for 4ch models
 <n> ::= {1 | 2} for 2ch models

- See Also**
- "[Introduction to :FUNCTION Commands](#)" on page 257
 - "[:FUNCTION:OPERation](#)" on page 264
 - "[:FUNCTION:GOFT:OPERation](#)" on page 260
 - "[:FUNCTION:GOFT:SOURce1](#)" on page 261
 - "[:FUNCTION:GOFT:SOURce2](#)" on page 262

:FUNCTION:SOURce2

N (see [page 740](#))

Command Syntax :FUNCTION:SOURce2 <value>

<value> ::= {CHANnel<n> | NONE}

<n> ::= {{1 | 2} | {3 | 4}} for 4ch models, depending on SOURce1 selection

<n> ::= {1 | 2} for 2ch models

The :FUNCTION:SOURce2 command is only used when an FFT (Fast Fourier Transform), DIFF, or INT operation is selected (see the:FUNCTION:OPERation command for more information about selecting an operation). The :FUNCTION:SOURce2 command selects the source for function operations. Choose CHANnel<n>, or ADD, SUBT, or MULT to specify the desired source for function DIFFerentiate, INTegrate, and FFT operations specified by the :FUNCTION:OPERation command.

If CHANnel1 or CHANnel2 is selected for :FUNCTION:SOURce1, the SOURce2 selection can be CHANnel1 or CHANnel2. Likewise, if CHANnel3 or CHANnel4 is selected for :FUNCTION:SOURce1, the SOURce2 selection can be CHANnel3 or CHANnel4.

Query Syntax :FUNCTION:SOURce2?

The :FUNCTION:SOURce2? query returns the second source for function operations on two waveforms.

Return Format <value><NL>

<value> ::= {CHAN<n> | NONE}

<n> ::= {{1 | 2} | {3 | 4}} for 4ch models, depending on SOURce1 selection

<n> ::= {1 | 2} for 2ch models

- See Also**
- ["Introduction to :FUNCTION Commands"](#) on page 257
 - [":FUNCTION:OPERation"](#) on page 264

:FUNCTION:SPAN

N (see [page 740](#))

Command Syntax :FUNCTION:SPAN

 ::= the current frequency span in NR3 format. Legal values are 1 Hz to 100 GHz.

If you set the frequency span to a value outside of the legal range, the step size is automatically set to the nearest legal value.

The :FUNCTION:SPAN command sets the frequency span of the display (left graticule to right graticule) when FFT (Fast Fourier Transform) is selected.

Query Syntax :FUNCTION:SPAN?

The :FUNCTION:SPAN? query returns the current frequency span in Hertz.

NOTE

After a *RST (Reset) or :AUToscale command, the values returned by the :FUNCTION:CENTer? and :FUNCTION:SPAN? queries depend on the current :TIMEbase:RANGe value. Once you change either the :FUNCTION:CENTer or :FUNCTION:SPAN value, they no longer track the :TIMEbase:RANGe value.

Return Format <NL>

 ::= the current frequency span in NR3 format. Legal values are 1 Hz to 100 GHz.

- See Also**
- ["Introduction to :FUNCTION Commands"](#) on page 257
 - [":FUNCTION:CENTer"](#) on page 258
 - [":TIMEbase:RANGe"](#) on page 446
 - [":TIMEbase:SCALE"](#) on page 449

:FUNCTION:WINDow

N (see [page 740](#))

Command Syntax :FUNCTION:WINDow <window>

<window> ::= {RECTangular | HANNing | FLATtop | BHARris}

The :FUNCTION:WINDow command allows the selection of four different windowing transforms or operations for the FFT (Fast Fourier Transform) function.

The FFT operation assumes that the time record repeats. Unless an integral number of sampled waveform cycles exist in the record, a discontinuity is created between the end of one record and the beginning of the next. This discontinuity introduces additional frequency components about the peaks into the spectrum. This is referred to as leakage. To minimize leakage, windows that approach zero smoothly at the start and end of the record are employed as filters to the FFTs. Each window is useful for certain classes of input signals.

- RECTangular – useful for transient signals, and signals where there are an integral number of cycles in the time record.
- HANNing – useful for frequency resolution and general purpose use. It is good for resolving two frequencies that are close together, or for making frequency measurements. This is the default window.
- FLATtop – best for making accurate amplitude measurements of frequency peaks.
- BHARris (Blackman-Harris) – reduces time resolution compared to the rectangular window, but it improves the capacity to detect smaller impulses due to lower secondary lobes (provides minimal spectral leakage).

Query Syntax :FUNCTION:WINDow?

The :FUNCTION:WINDow? query returns the value of the window selected for the FFT function.

Return Format <window><NL>

<window> ::= {RECT | HANN | FLAT | BHAR}

See Also • ["Introduction to :FUNCTION Commands"](#) on page 257

:HARDcopy Commands

Set and query the selection of hardcopy device and formatting options. See "Introduction to :HARDcopy Commands" on page 273.

Table 61 :HARDcopy Commands Summary

Command	Query	Options and Query Returns
:HARDcopy:AREA <area> (see page 274)	:HARDcopy:AREA? (see page 274)	<area> ::= SCREEN
:HARDcopy:APRinter <active_printer> (see page 275)	:HARDcopy:APRinter? (see page 275)	<active_printer> ::= {<index> <name>} <index> ::= integer index of printer in list <name> ::= name of printer in list
:HARDcopy:FACTors {{0 OFF} {1 ON}} (see page 276)	:HARDcopy:FACTors? (see page 276)	{0 1}
:HARDcopy:FFEed {{0 OFF} {1 ON}} (see page 277)	:HARDcopy:FFEed? (see page 277)	{0 1}
:HARDcopy:INKSaver {{0 OFF} {1 ON}} (see page 278)	:HARDcopy:INKSaver? (see page 278)	{0 1}
:HARDcopy:LAYout <layout> (see page 279)	:HARDcopy:LAYout? (see page 279)	<layout> ::= {LANDscape PORTRait}
:HARDcopy:PALette <palette> (see page 280)	:HARDcopy:PALette? (see page 280)	<palette> ::= {COLor GRAYscale NONE}
n/a	:HARDcopy:PRINter:LIS T? (see page 281)	<list> ::= [<printer_spec>] ... [printer_spec] <printer_spec> ::= "<index>,<active>,<name>;" <index> ::= integer index of printer <active> ::= {Y N} <name> ::= name of printer
:HARDcopy:STARt (see page 282)	n/a	n/a

Introduction to :HARDcopy Commands The HARDcopy subsystem provides commands to set and query the selection of hardcopy device and formatting options such as inclusion of instrument settings (FACTors) and generation of formfeed (FFEed).

:HARDC is an acceptable short form for :HARDcopy.

Reporting the Setup

Use :HARDcopy? to query setup information for the HARDcopy subsystem.

Return Format

The following is a sample response from the :HARDcopy? query. In this case, the query was issued following the *RST command.

```
:HARD:APR " ";AREA SCR;FACT 0;FFE 0;INKS 1;PAL NONE;LAY PORT
```

:HARDcopy:AREA

N (see [page 740](#))

Command Syntax :HARDcopy:AREA <area>
<area> ::= SCReen

The :HARDcopy:AREA command controls what part of the display area is printed. Currently, the only legal choice is SCReen.

Query Syntax :HARDcopy:AREA?

The :HARDcopy:AREA? query returns the selected display area.

Return Format <area><NL>
<area> ::= SCR

- See Also**
- ["Introduction to :HARDcopy Commands"](#) on page 273
 - [":HARDcopy:START"](#) on page 282
 - [":HARDcopy:APRinter"](#) on page 275
 - [":HARDcopy:PRINter:LIST"](#) on page 281
 - [":HARDcopy:FACTors"](#) on page 276
 - [":HARDcopy:FFEed"](#) on page 277
 - [":HARDcopy:INKSaver"](#) on page 278
 - [":HARDcopy:LAYout"](#) on page 279
 - [":HARDcopy:PALette"](#) on page 280

:HARDcopy:APRinter

N (see [page 740](#))

Command Syntax :HARDcopy:APRinter <active_printer>
 <active_printer> ::= {<index> | <name>}
 <index> ::= integer index of printer in list
 <name> ::= name of printer in list

The :HARDcopy:APRinter command sets the active printer.

Query Syntax :HARDcopy:APRinter?

The :HARDcopy:APRinter? query returns the name of the active printer.

Return Format <name><NL>
 <name> ::= name of printer in list

- See Also**
- ["Introduction to :HARDcopy Commands"](#) on page 273
 - [":HARDcopy:PRINter:LIST"](#) on page 281
 - [":HARDcopy:START"](#) on page 282

:HARDcopy:FACTors

N (see [page 740](#))

Command Syntax :HARDcopy:FACTors <factors>
<factors> ::= {{OFF | 0} | {ON | 1}}

The HARDcopy:FACTors command controls whether the scale factors are output on the hardcopy dump.

Query Syntax :HARDcopy:FACTors?

The :HARDcopy:FACTors? query returns a flag indicating whether oscilloscope instrument settings are output on the hardcopy.

Return Format <factors><NL>
<factors> ::= {0 | 1}

- See Also**
- ["Introduction to :HARDcopy Commands"](#) on page 273
 - [":HARDcopy:START"](#) on page 282
 - [":HARDcopy:FFEed"](#) on page 277
 - [":HARDcopy:INKSaver"](#) on page 278
 - [":HARDcopy:LAYout"](#) on page 279
 - [":HARDcopy:PALETTE"](#) on page 280

:HARDcopy:FFeed

N (see [page 740](#))

Command Syntax :HARDcopy:FFeed <ffeed>
 <ffeed> ::= {{OFF | 0} | {ON | 1}}

The HARDcopy:FFeed command controls whether a formfeed is output between the screen image and factors of a hardcopy dump.

ON (or 1) is only valid when PRINter0 or PRINter1 is set as the :HARDcopy:FORMat type.

Query Syntax :HARDcopy:FFeed?

The :HARDcopy:FFeed? query returns a flag indicating whether a formfeed is output at the end of the hardcopy dump.

Return Format <ffeed><NL>
 <ffeed> ::= {0 | 1}

- See Also**
- ["Introduction to :HARDcopy Commands"](#) on page 273
 - [":HARDcopy:START"](#) on page 282
 - [":HARDcopy:FACTors"](#) on page 276
 - [":HARDcopy:INKSaver"](#) on page 278
 - [":HARDcopy:LAYout"](#) on page 279
 - [":HARDcopy:PALette"](#) on page 280

:HARDcopy:INKSaver

N (see [page 740](#))

Command Syntax :HARDcopy:INKSaver <value>
<value> ::= {{OFF | 0} | {ON | 1}}

The HARDcopy:INKSaver command controls whether the graticule colors are inverted or not.

Query Syntax :HARDcopy:INKSaver?

The :HARDcopy:INKSaver? query returns a flag indicating whether graticule colors are inverted or not.

Return Format <value><NL>
<value> ::= {0 | 1}

- See Also**
- "[Introduction to :HARDcopy Commands](#)" on page 273
 - "[:HARDcopy:START](#)" on page 282
 - "[:HARDcopy:FACTors](#)" on page 276
 - "[:HARDcopy:FFEed](#)" on page 277
 - "[:HARDcopy:LAYout](#)" on page 279
 - "[:HARDcopy:PALETTE](#)" on page 280

:HARDcopy:LAYout

N (see [page 740](#))

Command Syntax :HARDcopy:LAYout <layout>

<layout> ::= {LANDscape | PORTrait}

The :HARDcopy:LAYout command sets the hardcopy layout mode.

Query Syntax :HARDcopy:LAYout?

The :HARDcopy:LAYout? query returns the selected hardcopy layout mode.

Return Format <layout><NL>

<layout> ::= {LAND | PORT}

- See Also**
- ["Introduction to :HARDcopy Commands"](#) on page 273
 - [":HARDcopy:START"](#) on page 282
 - [":HARDcopy:FACTors"](#) on page 276
 - [":HARDcopy:PALETTE"](#) on page 280
 - [":HARDcopy:FFEEd"](#) on page 277
 - [":HARDcopy:INKSaver"](#) on page 278

:HARDcopy:PALETTE

N (see [page 740](#))

Command Syntax :HARDcopy:PALETTE <palette>
<palette> ::= {COLOR | GRAYscale | NONE}

The :HARDcopy:PALETTE command sets the hardcopy palette color.

NOTE

If no printer is connected, NONE is the only valid parameter.

Query Syntax :HARDcopy:PALETTE?

The :HARDcopy:PALETTE? query returns the selected hardcopy palette color.

Return Format <palette><NL>
<palette> ::= {COL | GRAY | NONE}

- See Also**
- "[Introduction to :HARDcopy Commands](#)" on [page 273](#)
 - "[:HARDcopy:START](#)" on [page 282](#)
 - "[:HARDcopy:FACTors](#)" on [page 276](#)
 - "[:HARDcopy:LAYout](#)" on [page 279](#)
 - "[:HARDcopy:FFEed](#)" on [page 277](#)
 - "[:HARDcopy:INKSaver](#)" on [page 278](#)

:HARDcopy:PRINter:LIST

N (see [page 740](#))

Query Syntax :HARDcopy:PRINter:LIST?

The :HARDcopy:PRINter:LIST? query returns a list of available printers. The list can be empty.

Return Format <list><NL>

```
<list> ::= [<printer_spec>] ... [<printer_spec>]
<printer_spec> ::= "<index>,<active>,<name>;"
<index> ::= integer index of printer
<active> ::= {Y | N}
<name> ::= name of printer (for example "DESKJET 950C")
```

- See Also**
- ["Introduction to :HARDcopy Commands"](#) on page 273
 - [":HARDcopy:APRinter"](#) on page 275
 - [":HARDcopy:START"](#) on page 282

:HARDcopy:START

N (see [page 740](#))

Command Syntax :HARDcopy:START

The :HARDcopy:START command starts a print job.

- See Also**
- "[Introduction to :HARDcopy Commands](#)" on page 273
 - "[:HARDcopy:APRinter](#)" on page 275
 - "[:HARDcopy:PRINter:LIST](#)" on page 281
 - "[:HARDcopy:FACTors](#)" on page 276
 - "[:HARDcopy:FFEed](#)" on page 277
 - "[:HARDcopy:INKSaver](#)" on page 278
 - "[:HARDcopy:LAYout](#)" on page 279
 - "[:HARDcopy:PALETTE](#)" on page 280

:MARKer Commands

Set and query the settings of X-axis markers (X1 and X2 cursors) and the Y-axis markers (Y1 and Y2 cursors). See "[Introduction to :MARKer Commands](#)" on page 284.

Table 62 :MARKer Commands Summary

Command	Query	Options and Query Returns
:MARKer:MODE <mode> (see page 285)	:MARKer:MODE? (see page 285)	<mode> ::= {OFF MEASurement MANual WAVEform}
:MARKer:X1Position <position>[suffix] (see page 286)	:MARKer:X1Position? (see page 286)	<position> ::= X1 cursor position value in NR3 format [suffix] ::= {s ms us ns ps Hz kHz MHz} <return_value> ::= X1 cursor position value in NR3 format
:MARKer:X1Y1source <source> (see page 287)	:MARKer:X1Y1source? (see page 287)	<source> ::= {CHANnel<n> FUNCTION MATH} <n> ::= 1-2 or 1-4 in NR1 format <return_value> ::= <source>
:MARKer:X2Position <position>[suffix] (see page 288)	:MARKer:X2Position? (see page 288)	<position> ::= X2 cursor position value in NR3 format [suffix] ::= {s ms us ns ps Hz kHz MHz} <return_value> ::= X2 cursor position value in NR3 format
:MARKer:X2Y2source <source> (see page 289)	:MARKer:X2Y2source? (see page 289)	<source> ::= {CHANnel<n> FUNCTION MATH} <n> ::= 1-2 or 1-4 in NR1 format <return_value> ::= <source>
n/a	:MARKer:XDELta? (see page 290)	<return_value> ::= X cursors delta value in NR3 format
:MARKer:Y1Position <position>[suffix] (see page 291)	:MARKer:Y1Position? (see page 291)	<position> ::= Y1 cursor position value in NR3 format [suffix] ::= {V mV dB} <return_value> ::= Y1 cursor position value in NR3 format

Table 62 :MARKer Commands Summary (continued)

Command	Query	Options and Query Returns
:MARKer:Y2Position <position>[suffix] (see page 292)	:MARKer:Y2Position? (see page 292)	<position> ::= Y2 cursor position value in NR3 format [suffix] ::= {V mV dB} <return_value> ::= Y2 cursor position value in NR3 format
n/a	:MARKer:YDELta? (see page 293)	<return_value> ::= Y cursors delta value in NR3 format

Introduction to :MARKer Commands The MARKer subsystem commands set and query the settings of X-axis markers (X1 and X2 cursors) and the Y-axis markers (Y1 and Y2 cursors). You can set and query the marker mode and source, the position of the X and Y cursors, and query delta X and delta Y cursor values.

Reporting the Setup

Use :MARKer? to query setup information for the MARKer subsystem.

Return Format

The following is a sample response from the :MARKer? query. In this case, the query was issued following a *RST and :MARKer:MODE:MANual command.

```
:MARK:X1Y1 NONE;X2Y2 NONE;MODE OFF
```

:MARKer:MODE

N (see [page 740](#))

Command Syntax :MARKer:MODE <mode>

<mode> ::= {OFF | MEASurement | MANual | WAVeform}

The :MARKer:MODE command sets the cursors mode:

- OFF – removes the cursor information from the display.
- MANual – enables manual placement of the X and Y cursors.

If the front-panel cursors are off, or are set to the front-panel Hex or Binary mode, setting :MARKer:MODE MANual will put the cursors in the front-panel Normal mode.

- MEASurement – cursors track the most recent measurement.

Setting the mode to MEASurement sets the marker sources (:MARKer:X1Y1source and :MARKer:X2Y2source) to the measurement source (:MEASure:SOURce). Setting the measurement source remotely always sets the marker sources.

- WAVeform – the Y1 cursor tracks the voltage value at the X1 cursor of the waveform specified by the X1Y1source, and the Y2 cursor does the same for the X2 cursor and its X2Y2source.

Query Syntax :MARKer:MODE?

The :MARKer:MODE? query returns the current cursors mode.

Return Format <mode><NL>

<mode> ::= {OFF | MEAS | MAN | WAV}

- See Also**
- "[Introduction to :MARKer Commands](#)" on page 284
 - "[:MARKer:X1Y1source](#)" on page 287
 - "[:MARKer:X2Y2source](#)" on page 289
 - "[:MEASure:SOURce](#)" on page 325
 - "[:MARKer:X1Position](#)" on page 286
 - "[:MARKer:X2Position](#)" on page 288
 - "[:MARKer:Y1Position](#)" on page 291
 - "[:MARKer:Y2Position](#)" on page 292

:MARKer:X1Position

N (see page 740)

Command Syntax :MARKer:X1Position <position> [suffix]
<position> ::= X1 cursor position in NR3 format
<suffix> ::= {s | ms | us | ns | ps | Hz | kHz | MHz}

The :MARKer:X1Position command:

- Sets :MARKer:MODE to MANual if it is not currently set to WAVEform (see ":MARKer:MODE" on page 285).
- Sets the X1 cursor position to the specified value.

Query Syntax :MARKer:X1Position?

The :MARKer:X1Position? query returns the current X1 cursor position. This is functionally equivalent to the obsolete :MEASure:TSTArt command/query.

NOTE

If the front-panel cursors are off, the marker position values are not defined and an error is generated. Make sure to set :MARKer:MODE to MANual or WAVEform to put the cursors in the front-panel Normal mode.

Return Format <position><NL>
<position> ::= X1 cursor position in NR3 format

- See Also**
- "Introduction to :MARKer Commands" on page 284
 - ":MARKer:MODE" on page 285
 - ":MARKer:X2Position" on page 288
 - ":MARKer:X1Y1source" on page 287
 - ":MARKer:X2Y2source" on page 289
 - ":MEASure:TSTArt" on page 672

:MARKer:X1Y1source

N (see [page 740](#))

Command Syntax :MARKer:X1Y1source <source>
 <source> ::= {CHANnel<n> | FUNCTION | MATH}
 <n> ::= {1 | 2 | 3 | 4} for the four channel oscilloscope models
 <n> ::= {1 | 2} for the two channel oscilloscope models

The :MARKer:X1Y1source command sets the source for the cursors. The channel you specify must be enabled for cursors to be displayed. If the channel or function is not on, an error message is issued.

If the marker mode is not currently WAVEform (see [":MARKer:MODE"](#) on [page 285](#)):

- Sending a :MARKer:X1Y1source command will put the cursors in the MANual mode.
- Setting the source for one pair of markers (for example, X1Y1) sets the source for the other (for example, X2Y2).

If the marker mode is currently WAVEform, the X1Y1 source can be set separate from the X2Y2 source.

If :MARKer:MODE is set to OFF or MANual, setting :MEASure:SOURce to CHANnel<n>, FUNCTION, or MATH will also set :MARKer:X1Y1source and :MARKer:X2Y2source to this value.

NOTE

MATH is an alias for FUNCTION. The query will return FUNC if the source is FUNCTION or MATH.

Query Syntax :MARKer:X1Y1source?

The :MARKer:X1Y1source? query returns the current source for the cursors. If all channels are off or if :MARKer:MODE is set to OFF, the query returns NONE.

Return Format <source><NL>
 <source> ::= {CHAN<n> | FUNC | NONE}

- See Also**
- ["Introduction to :MARKer Commands"](#) on [page 284](#)
 - [":MARKer:MODE"](#) on [page 285](#)
 - [":MARKer:X2Y2source"](#) on [page 289](#)
 - [":MEASure:SOURce"](#) on [page 325](#)

:MARKer:X2Position

N (see [page 740](#))

Command Syntax :MARKer:X2Position <position> [suffix]
<position> ::= X2 cursor position in NR3 format
<suffix> ::= {s | ms | us | ns | ps | Hz | kHz | MHz}

The :MARKer:X2Position command:

- Sets :MARKer:MODE to MANual if it is not currently set to WAVEform (see [":MARKer:MODE"](#) on page 285).
- Sets the X2 cursor position to the specified value.

Query Syntax :MARKer:X2Position?

The :MARKer:X2Position? query returns current X2 cursor position. This is functionally equivalent to the obsolete :MEASure:TSTOp command/query.

NOTE

If the front-panel cursors are off, the marker position values are not defined and an error is generated. Make sure to set :MARKer:MODE to MANual or WAVEform to put the cursors in the front-panel Normal mode.

Return Format <position><NL>
<position> ::= X2 cursor position in NR3 format

- See Also**
- ["Introduction to :MARKer Commands"](#) on page 284
 - [":MARKer:MODE"](#) on page 285
 - [":MARKer:X1Position"](#) on page 286
 - [":MARKer:X2Y2source"](#) on page 289
 - [":MEASure:TSTOp"](#) on page 673

:MARKer:X2Y2source

N (see [page 740](#))

Command Syntax :MARKer:X2Y2source <source>

<source> ::= {CHANnel<n> | FUNCTION | MATH}

<n> ::= {1 | 2 | 3 | 4} for the four channel oscilloscope models

<n> ::= {1 | 2} for the two channel oscilloscope models

The :MARKer:X2Y2source command sets the source for the cursors. The channel you specify must be enabled for cursors to be displayed. If the channel or function is not on, an error message is issued.

If the marker mode is not currently WAVEform (see [":MARKer:MODE"](#) on [page 285](#)):

- Sending a :MARKer:X2Y2source command will put the cursors in the MANual mode.
- Setting the source for one pair of markers (for example, X2Y2) sets the source for the other (for example, X1Y1).

If the marker mode is currently WAVEform, the X2Y2 source can be set separate from the X1Y1 source.

If :MARKer:MODE is set to OFF or MANual, setting :MEASure:SOURce to CHANnel<n>, FUNCTION, or MATH will also set :MARKer:X1Y1source and :MARKer:X2Y2source to this value.

NOTE

MATH is an alias for FUNCTION. The query will return FUNC if the source is FUNCTION or MATH.

Query Syntax :MARKer:X2Y2source?

The :MARKer:X2Y2source? query returns the current source for the cursors. If all channels are off or if :MARKer:MODE is set to OFF, the query returns NONE.

Return Format <source><NL>

<source> ::= {CHAN<n> | FUNC | NONE}

- See Also**
- ["Introduction to :MARKer Commands"](#) on [page 284](#)
 - [":MARKer:MODE"](#) on [page 285](#)
 - [":MARKer:X1Y1source"](#) on [page 287](#)
 - [":MEASure:SOURce"](#) on [page 325](#)

:MARKer:XDELta

N (see [page 740](#))

Query Syntax :MARKer:XDELta?

The MARKer:XDELta? query returns the value difference between the current X1 and X2 cursor positions.

Xdelta = (Value at X2 cursor) - (Value at X1 cursor)

NOTE

If the front-panel cursors are off, the marker position values are not defined. Make sure to set :MARKer:MODE to MANual or WAVEform to put the cursors in the front-panel Normal mode.

Return Format <value><NL>

<value> ::= difference value in NR3 format.

- See Also**
- "[Introduction to :MARKer Commands](#)" on [page 284](#)
 - "[:MARKer:MODE](#)" on [page 285](#)
 - "[:MARKer:X1Position](#)" on [page 286](#)
 - "[:MARKer:X2Position](#)" on [page 288](#)
 - "[:MARKer:X1Y1source](#)" on [page 287](#)
 - "[:MARKer:X2Y2source](#)" on [page 289](#)

:MARKer:Y1Position

N (see [page 740](#))

Command Syntax :MARKer:Y1Position <position> [suffix]
 <position> ::= Y1 cursor position in NR3 format
 <suffix> ::= {mV | V | dB}

If the :MARKer:MODE is not currently set to WAVEform (see "[:MARKer:MODE](#)" on [page 285](#)), the :MARKer:Y1Position command:

- Sets :MARKer:MODE to MANual.
- Sets the Y1 cursor position to the specified value.

When the :MARKer:MODE is set to WAVEform, Y positions cannot be set.

Query Syntax :MARKer:Y1Position?

The :MARKer:Y1Position? query returns current Y1 cursor position. This is functionally equivalent to the obsolete :MEASure:VSTart command/query.

NOTE

If the front-panel cursors are off or are set to Binary or Hex Mode, the marker position values are not defined and an error is generated. Make sure to set :MARKer:MODE to MANual or WAVEform to put the cursors in the front-panel Normal mode.

Return Format <position><NL>
 <position> ::= Y1 cursor position in NR3 format

- See Also**
- "[Introduction to :MARKer Commands](#)" on [page 284](#)
 - "[:MARKer:MODE](#)" on [page 285](#)
 - "[:MARKer:X1Y1source](#)" on [page 287](#)
 - "[:MARKer:X2Y2source](#)" on [page 289](#)
 - "[:MARKer:Y2Position](#)" on [page 292](#)
 - "[:MEASure:VSTart](#)" on [page 678](#)

:MARKer:Y2Position

N (see [page 740](#))

Command Syntax :MARKer:Y2Position <position> [suffix]
 <position> ::= Y2 cursor position in NR3 format
 <suffix> ::= {mV | V | dB}

If the :MARKer:MODE is not currently set to WAVEform (see "[:MARKer:MODE](#)" on [page 285](#)), the :MARKer:Y1Position command:

- Sets :MARKer:MODE to MANual.
- Sets the Y2 cursor position to the specified value.

When the :MARKer:MODE is set to WAVEform, Y positions cannot be set.

Query Syntax :MARKer:Y2Position?

The :MARKer:Y2Position? query returns current Y2 cursor position. This is functionally equivalent to the obsolete :MEASure:VSTOP command/query.

NOTE

If the front-panel cursors are off or are set to Binary or Hex Mode, the marker position values are not defined and an error is generated. Make sure to set :MARKer:MODE to MANual or WAVEform to put the cursors in the front-panel Normal mode.

Return Format <position><NL>
 <position> ::= Y2 cursor position in NR3 format

- See Also**
- "[Introduction to :MARKer Commands](#)" on [page 284](#)
 - "[:MARKer:MODE](#)" on [page 285](#)
 - "[:MARKer:X1Y1source](#)" on [page 287](#)
 - "[:MARKer:X2Y2source](#)" on [page 289](#)
 - "[:MARKer:Y1Position](#)" on [page 291](#)
 - "[:MEASure:VSTOP](#)" on [page 679](#)

:MARKer:YDELta

N (see [page 740](#))

Query Syntax :MARKer:YDELta?

The :MARKer:YDELta? query returns the value difference between the current Y1 and Y2 cursor positions.

Ydelta = (Value at Y2 cursor) - (Value at Y1 cursor)

NOTE

If the front-panel cursors are off or are set to Binary or Hex Mode, the marker position values are not defined. Make sure to set :MARKer:MODE to MANual or WAVeform to put the cursors in the front-panel Normal mode.

Return Format <value><NL>

<value> ::= difference value in NR3 format

- See Also**
- ["Introduction to :MARKer Commands"](#) on page 284
 - [":MARKer:MODE"](#) on page 285
 - [":MARKer:X1Y1source"](#) on page 287
 - [":MARKer:X2Y2source"](#) on page 289
 - [":MARKer:Y1Position"](#) on page 291
 - [":MARKer:Y2Position"](#) on page 292

:MEASure Commands

Select automatic measurements to be made and control time markers. See "Introduction to :MEASure Commands" on page 300.

Table 63 :MEASure Commands Summary

Command	Query	Options and Query Returns
:MEASure:CLEar (see page 302)	n/a	n/a
:MEASure:COUNter [<source>] (see page 303)	:MEASure:COUNter? [<source>] (see page 303)	<source> ::= {CHANnel<n> EXTernal} for DSO models <source> ::= {CHANnel<n> DIGital0,..,DIGital15 EXTernal} for MSO models <n> ::= 1-2 or 1-4 in NR1 format <return_value> ::= counter frequency in Hertz in NR3 format
:MEASure:DEFine DELay, <delay spec> (see page 304)	:MEASure:DEFine? DELay (see page 305)	<delay spec> ::= <edge_spec1>,<edge_spec2> edge_spec1 ::= [<slope>]<occurrence> edge_spec2 ::= [<slope>]<occurrence> <slope> ::= {+ -} <occurrence> ::= integer
:MEASure:DEFine THResholds, <threshold spec> (see page 304)	:MEASure:DEFine? THResholds (see page 305)	<threshold spec> ::= {STANdard} {<threshold mode>,<upper>,<middle>,<lower>} <threshold mode> ::= {PERCent ABSolute}
:MEASure:DELay [<source1>] [,<source2>] (see page 307)	:MEASure:DELay? [<source1>] [,<source2>] (see page 307)	<source1,2> ::= {CHANnel<n> FUNction MATH} <n> ::= 1-2 or 1-4 in NR1 format <return_value> ::= floating-point number delay time in seconds in NR3 format
:MEASure:DUTYcycle [<source>] (see page 309)	:MEASure:DUTYcycle? [<source>] (see page 309)	<source> ::= {CHANnel<n> FUNction MATH} for DSO models <source> ::= {CHANnel<n> DIGital0,..,DIGital15 FUNction MATH} for MSO models <n> ::= 1-2 or 1-4 in NR1 format <return_value> ::= ratio of positive pulse width to period in NR3 format

Table 63 :MEASure Commands Summary (continued)

Command	Query	Options and Query Returns
:MEASure:FALLtime [<source>] (see page 310)	:MEASure:FALLtime? [<source>] (see page 310)	<source> ::= {CHANnel<n> FUNctIon MATH} for DSO models <source> ::= {CHANnel<n> DIGital0,...,DIGital15 FUNctIon MATH} for MSO models <n> ::= 1-2 or 1-4 in NR1 format <return_value> ::= time in seconds between the lower and upper thresholds in NR3 format
:MEASure:FREQuency [<source>] (see page 311)	:MEASure:FREQuency? [<source>] (see page 311)	<source> ::= {CHANnel<n> FUNctIon MATH} for DSO models <source> ::= {CHANnel<n> DIGital0,...,DIGital15 FUNctIon MATH} for MSO models <n> ::= 1-2 or 1-4 in NR1 format <return_value> ::= frequency in Hertz in NR3 format
:MEASure:NWIDth [<source>] (see page 312)	:MEASure:NWIDth? [<source>] (see page 312)	<source> ::= {CHANnel<n> FUNctIon MATH} for DSO models <source> ::= {CHANnel<n> DIGital0,...,DIGital15 FUNctIon MATH} for MSO models <n> ::= 1-2 or 1-4 in NR1 format <return_value> ::= negative pulse width in seconds-NR3 format
:MEASure:OVERshoot [<source>] (see page 313)	:MEASure:OVERshoot? [<source>] (see page 313)	<source> ::= {CHANnel<n> FUNctIon MATH} <n> ::= 1-2 or 1-4 in NR1 format <return_value> ::= the percent of the overshoot of the selected waveform in NR3 format
:MEASure:PERiod [<source>] (see page 315)	:MEASure:PERiod? [<source>] (see page 315)	<source> ::= {CHANnel<n> FUNctIon MATH} for DSO models <source> ::= {CHANnel<n> DIGital0,...,DIGital15 FUNctIon MATH} for MSO models <n> ::= 1-2 or 1-4 in NR1 format <return_value> ::= waveform period in seconds in NR3 format

5 Commands by Subsystem

Table 63 :MEASure Commands Summary (continued)

Command	Query	Options and Query Returns
:MEASure:PHASe [<source1>] [,<source2>] (see page 316)	:MEASure:PHASe? [<source1>] [,<source2>] (see page 316)	<source1,2> ::= {CHANnel<n> FUNction MATH} <n> ::= 1-2 or 1-4 in NR1 format <return_value> ::= the phase angle value in degrees in NR3 format
:MEASure:PREShoOt [<source>] (see page 317)	:MEASure:PREShoOt? [<source>] (see page 317)	<source> ::= {CHANnel<n> FUNction MATH} <n> ::= 1-2 or 1-4 in NR1 format <return_value> ::= the percent of preshoot of the selected waveform in NR3 format
:MEASure:PWIDth [<source>] (see page 318)	:MEASure:PWIDth? [<source>] (see page 318)	<source> ::= {CHANnel<n> FUNction MATH} for DSO models <source> ::= {CHANnel<n> DIGital0,..,DIGital15 FUNction MATH} for MSO models <n> ::= 1-2 or 1-4 in NR1 format <return_value> ::= width of positive pulse in seconds in NR3 format
n/a	:MEASure:RESults? <result_list> (see page 319)	<result_list> ::= comma-separated list of measurement results
:MEASure:RISEtime [<source>] (see page 322)	:MEASure:RISEtime? [<source>] (see page 322)	<source> ::= {CHANnel<n> FUNction MATH} <n> ::= 1-2 or 1-4 in NR1 format <return_value> ::= rise time in seconds in NR3 format
:MEASure:SDEVIation [<source>] (see page 323)	:MEASure:SDEVIation? [<source>] (see page 323)	<source> ::= {CHANnel<n> FUNction MATH} <n> ::= 1-2 or 1-4 in NR1 format <return_value> ::= calculated std deviation in NR3 format
:MEASure:SHOW {1 ON} (see page 324)	:MEASure:SHOW? (see page 324)	{1}

Table 63 :MEASure Commands Summary (continued)

Command	Query	Options and Query Returns
:MEASure:SOURce <source1> [,<source2>] (see page 325)	:MEASure:SOURce? (see page 325)	<source1,2> ::= {CHANnel<n> FUNctIon MATH EXtErnal} for DSO models <source1,2> ::= {CHANnel<n> DIGital0,...,DIGital15 FUNctIon MATH EXtErnal} for MSO models <n> ::= 1-2 or 1-4 in NR1 format <return_value> ::= {<source> NONE}
:MEASure:STATistics <type> (see page 327)	:MEASure:STATistics? (see page 327)	<type> ::= {{ON 1} CURRent MEAN MINimum MAXimum STDDev COUNT} ON ::= all statistics returned
:MEASure:STATistics:INCRement (see page 328)	n/a	n/a
:MEASure:STATistics:RESET (see page 329)	n/a	n/a
n/a	:MEASure:TEDGE? <slope><occurrence>[, <source>] (see page 330)	<slope> ::= direction of the waveform <occurrence> ::= the transition to be reported <source> ::= {CHANnel<n> FUNctIon MATH} for DSO models <source> ::= {CHANnel<n> DIGital0,...,DIGital15 FUNctIon MATH} for MSO models <n> ::= 1-2 or 1-4 in NR1 format <return_value> ::= time in seconds of the specified transition

Table 63 :MEASure Commands Summary (continued)

Command	Query	Options and Query Returns
n/a	:MEASure:TVALue? <value>, [<slope>]<occurrence> [,<source>] (see page 332)	<value> ::= voltage level that the waveform must cross. <slope> ::= direction of the waveform when <value> is crossed. <occurrence> ::= transitions reported. <return_value> ::= time in seconds of specified voltage crossing in NR3 format <source> ::= {CHANnel<n> FUNctIon MATH} for DSO models <source> ::= {CHANnel<n> DIGital0,..,DIGital15 FUNctIon MATH} for MSO models <n> ::= 1-2 or 1-4 in NR1 format
:MEASure:VAMPLitude [<source>] (see page 334)	:MEASure:VAMPLitude? [<source>] (see page 334)	<source> ::= {CHANnel<n> FUNctIon MATH} <n> ::= 1-2 or 1-4 in NR1 format <return_value> ::= the amplitude of the selected waveform in volts in NR3 format
:MEASure:VAverage [<source>] (see page 335)	:MEASure:VAverage? [<source>] (see page 335)	<source> ::= {CHANnel<n> FUNctIon MATH} <n> ::= 1-2 or 1-4 in NR1 format <return_value> ::= calculated average voltage in NR3 format
:MEASure:VBASe [<source>] (see page 336)	:MEASure:VBASe? [<source>] (see page 336)	<source> ::= {CHANnel<n> FUNctIon MATH} <n> ::= 1-2 or 1-4 in NR1 format <base_voltage> ::= voltage at the base of the selected waveform in NR3 format
:MEASure:VMAX [<source>] (see page 337)	:MEASure:VMAX? [<source>] (see page 337)	<source> ::= {CHANnel<n> FUNctIon MATH} <n> ::= 1-2 or 1-4 in NR1 format <return_value> ::= maximum voltage of the selected waveform in NR3 format
:MEASure:VMIN [<source>] (see page 338)	:MEASure:VMIN? [<source>] (see page 338)	<source> ::= {CHANnel<n> FUNctIon MATH} <n> ::= 1-2 or 1-4 in NR1 format <return_value> ::= minimum voltage of the selected waveform in NR3 format

Table 63 :MEASure Commands Summary (continued)

Command	Query	Options and Query Returns
:MEASure:VPP [<source>] (see page 339)	:MEASure:VPP? [<source>] (see page 339)	<source> ::= {CHANnel<n> FUNction MATH} <n> ::= 1-2 or 1-4 in NR1 format <return_value> ::= voltage peak-to-peak of the selected waveform in NR3 format
:MEASure:VRATio [<source1>] [,<source2>] (see page 316)	:MEASure:VRATio? [<source1>] [,<source2>] (see page 340)	<source1,2> ::= {CHANnel<n> FUNction MATH} <n> ::= 1-2 or 1-4 in NR1 format <return_value> ::= the ratio value in dB in NR3 format
:MEASure:VRMS [<source>] (see page 341)	:MEASure:VRMS? [<source>] (see page 341)	<source> ::= {CHANnel<n> FUNction MATH} <n> ::= 1-2 or 1-4 in NR1 format <return_value> ::= calculated dc RMS voltage in NR3 format
n/a	:MEASure:VTIME? <vtime>[,<source>] (see page 342)	<vtime> ::= displayed time from trigger in seconds in NR3 format <return_value> ::= voltage at the specified time in NR3 format <source> ::= {CHANnel<n> FUNction MATH} for DSO models <source> ::= {CHANnel<n> DIGital0,...,DIGital15 FUNction MATH} for MSO models <n> ::= 1-2 or 1-4 in NR1 format
:MEASure:VTOP [<source>] (see page 343)	:MEASure:VTOP? [<source>] (see page 343)	<source> ::= {CHANnel<n> FUNction MATH} <n> ::= 1-2 or 1-4 in NR1 format <return_value> ::= voltage at the top of the waveform in NR3 format
:MEASure:XMAX [<source>] (see page 344)	:MEASure:XMAX? [<source>] (see page 344)	<source> ::= {CHANnel<n> FUNction MATH} <n> ::= 1-2 or 1-4 in NR1 format <return_value> ::= horizontal value of the maximum in NR3 format
:MEASure:XMIN [<source>] (see page 345)	:MEASure:XMIN? [<source>] (see page 345)	<source> ::= {CHANnel<n> FUNction MATH} <n> ::= 1-2 or 1-4 in NR1 format <return_value> ::= horizontal value of the maximum in NR3 format

**Introduction to
:MEASure
Commands**

The commands in the MEASure subsystem are used to make parametric measurements on displayed waveforms.

Measurement Setup

To make a measurement, the portion of the waveform required for that measurement must be displayed on the oscilloscope screen.

Measurement Type	Portion of waveform that must be displayed
period, duty cycle, or frequency	at least one complete cycle
pulse width	the entire pulse
rise time	rising edge, top and bottom of pulse
fall time	falling edge, top and bottom of pulse

Measurement Error

If a measurement cannot be made (typically because the proper portion of the waveform is not displayed), the value +9.9E+37 is returned for that measurement.

Making Measurements

If more than one waveform, edge, or pulse is displayed, time measurements are made on the portion of the displayed waveform closest to the trigger reference (left, center, or right).

When making measurements in the zoomed (delayed) time base mode (:TIMEbase:MODE WINDOW), the oscilloscope will attempt to make the measurement inside the zoomed sweep window. If the measurement is an average and there are not three edges, the oscilloscope will revert to the mode of making the measurement at the start of the main sweep.

When the command form is used, the measurement result is displayed on the instrument. When the query form of these measurements is used, the measurement is made one time, and the measurement result is returned over the bus.

Measurements are made on the displayed waveforms specified by the :MEASure:SOURce command. The MATH source is an alias for the FUNCtion source.

Not all measurements are available on the digital channels or FFT (Fast Fourier Transform).

Reporting the Setup

Use the :MEASure? query to obtain setup information for the MEASure subsystem. (Currently, this is only :MEASure:SOURce.)

Return Format

The following is a sample response from the :MEASure? query. In this case, the query was issued following a *RST command.

```
:MEAS:SOUR CHAN1,CHAN2;STAT ON
```

:MEASure:CLEar

N (see [page 740](#))

Command Syntax :MEASure:CLEar

This command clears all selected measurements and markers from the screen.

See Also • ["Introduction to :MEASure Commands"](#) on page 300

:MEASure:COUNter

N (see [page 740](#))

Command Syntax :MEASure:COUNter [<source>]
 <source> ::= {<digital channels> | CHANnel<n> | EXTernal}
 <digital channels> ::= DIGital0,...,DIGital15 for the MSO models
 <n> ::= {1 | 2 | 3 | 4} for the four channel oscilloscope models
 <n> ::= {1 | 2} for the two channel oscilloscope models

The :MEASure:COUNter command installs a screen measurement and starts a counter measurement. If the optional source parameter is specified, the current source is modified. Any channel except Math may be selected for the source.

The counter measurement counts trigger level crossings at the selected trigger slope and displays the results in Hz. The gate time for the measurement is automatically adjusted to be 100 ms or twice the current time window, whichever is longer, up to 1 second. The counter measurement can measure frequencies up to 125 MHz. The minimum frequency supported is 1/(2 X gate time).

The Y cursor shows the the edge threshold level used in the measurement.

Only one counter measurement may be displayed at a time.

NOTE

This command is not available if the source is MATH.

Query Syntax :MEASure:COUNter? [<source>]

The :MEASure:COUNter? query measures and outputs the counter frequency of the specified source.

NOTE

The :MEASure:COUNter? query times out if the counter measurement is installed on the front panel. Use :MEASure:CLEar to remove the front-panel measurement before executing the :MEASure:COUNter? query.

Return Format <source><NL>

<source> ::= count in Hertz in NR3 format

- See Also**
- ["Introduction to :MEASure Commands"](#) on page 300
 - [":MEASure:SOURce"](#) on page 325
 - [":MEASure:FREQuency"](#) on page 311
 - [":MEASure:CLEar"](#) on page 302

:MEASure:DEFine

N (see page 740)

Command Syntax :MEASure:DEFine <meas_spec>

<meas_spec> ::= {DELay | THResholds}

The :MEASure:DEFine command sets up the definition for measurements by specifying the delta time or threshold values. Changing these values may affect the results of other measure commands. The table below identifies which measurement results that can be affected by redefining the DELay specification or the THResholds values. For example, changing the THResholds definition from the default 10%, 50%, and 90% values may change the returned measurement result.

MEASure Command	DELay	THResholds
DUTYcycle		x
DELay	x	x
FALLtime		x
FREQuency		x
NWIDth		x
OVERshoot		x
PERiod		x
PHASe		x
PREShoot		x
PWIDth		x
RISetime		x
VAVerage		x
VRMS		x

:MEASure:DEFine DELay Command Syntax :MEASure:DEFine DELay,<delay_spec>

DELay Command Syntax

<delay_spec> ::= <edge_spec1>,<edge_spec2>

<edge_spec1> ::= [<slope>]<occurrence>

<edge_spec2> ::= [<slope>]<occurrence>

<slope> ::= {+ | -}

<occurrence> ::= integer

This command defines the behavior of the `:MEASure:DElay?` query by specifying the start and stop edge to be used. `<edge_spec1>` specifies the slope and edge number on source1. `<edge_spec2>` specifies the slope and edge number on source2. The measurement is taken as:

$$\text{delay} = t(\text{<edge_spec2>}) - t(\text{<edge_spec1>})$$

NOTE

The `:MEASure:DElay` command and the front-panel delay measurement use an auto-edge selection method to determine the actual edge used for the measurement. The `:MEASure:DEfine` command has no effect on these delay measurements. The edges specified by the `:MEASure:DEfine` command only define the edges used by the `:MEASure:DElay?` query.

:MEASure:DEfine THResholds Command Syntax

```
:MEASure:DEfine THResholds,<threshold spec>
```

```
<threshold spec> ::= {STANdard  
                    | {<threshold mode>,<upper>,<middle>,<lower>}}
```

```
<threshold mode> ::= {PERCent | ABSolute}
```

for `<threshold mode> = PERCent`:

```
<upper>,<middle>,<lower> ::= A number specifying the upper, middle,  
                             and lower threshold percentage values  
                             between Vbase and Vtop in NR3 format.
```

for `<threshold mode> = ABSolute`:

```
<upper>,<middle>,<lower> ::= A number specifying the upper, middle,  
                             and lower threshold absolute values in  
                             NR3 format.
```

- STANdard threshold specification sets the lower, middle, and upper measurement thresholds to 10%, 50%, and 90% values between Vbase and Vtop.
- Threshold mode PERCent sets the measurement thresholds to any user-defined percentages between 5% and 95% of values between Vbase and Vtop.
- Threshold mode ABSolute sets the measurement thresholds to absolute values. ABSolute thresholds are dependent on channel scaling (`:CHANnel<n>:RANGe` or `" :CHANnel<n>:SCALe"` on page 225:`CHANnel<n>:SCALe`), probe attenuation (`:CHANnel<n>:PROBe`), and probe units (`:CHANnel<n>:UNITs`). Always set these values first before setting ABSolute thresholds.

Query Syntax

```
:MEASure:DEfine? <meas_spec>
```

```
<meas_spec> ::= {DElay | THResholds}
```

The `:MEASure:DEfine?` query returns the current edge specification for the delay measurements setup or the current specification for the thresholds setup.

Return Format for <meas_spec> = DELay:

```
{ <edge_spec1> | <edge_spec2> | <edge_spec1>,<edge_spec2>} <NL>
```

for <meas_spec> = THResholds and <threshold mode> = PERCent:

```
THR,PERC,<upper>,<middle>,<lower><NL>
```

<upper>, <middle>, <lower> ::= A number specifying the upper, middle, and lower threshold percentage values between Vbase and Vtop in NR3 format.

for <meas_spec> = THResholds and <threshold mode> = ABSolute:

```
THR,ABS,<upper>,<middle>,<lower><NL>
```

<upper>, <middle>, <lower> ::= A number specifying the upper, middle, and lower threshold voltages in NR3 format.

for <threshold spec> = STANdard:

```
THR,PERC,+90.0,+50.0,+10.0
```

- See Also**
- ["Introduction to :MEASure Commands"](#) on page 300
 - [":MEASure:DELay"](#) on page 307
 - [":MEASure:SOURce"](#) on page 325
 - [":CHANnel<n>:RANGe"](#) on page 224
 - [":CHANnel<n>:SCALE"](#) on page 225
 - [":CHANnel<n>:PROBE"](#) on page 219
 - [":CHANnel<n>:UNITs"](#) on page 226

:MEASure:DElay

N (see page 740)

Command Syntax :MEASure:DElay [<source1>][,<source2>]
 <source1>, <source2> ::= {CHANnel<n> | FUNction | MATH}
 <n> ::= {1 | 2 | 3 | 4} for the four channel oscilloscope models
 <n> ::= {1 | 2} for the two channel oscilloscope models

The :MEASure:DElay command places the instrument in the continuous measurement mode and starts a delay measurement.

The measurement is taken as:

$$\text{delay} = t(\text{<edge spec 2>}) - t(\text{<edge spec 1>})$$

where the <edge spec> definitions are set by the :MEASure:DEFine command

NOTE

The :MEASure:DElay command and the front-panel delay measurement differ from the :MEASure:DElay? query.

The delay command or front-panel measurement run the delay measurement in auto-edge select mode. In this mode, you can select the edge polarity, but the instrument will select the edges that will make the best possible delay measurement. The source1 edge chosen will be the edge that meets the polarity specified and is closest to the trigger reference point. The source2 edge selected will be that edge of the specified polarity that gives the first of the following criteria:

- The smallest positive delay value that is less than source1 period.
- The smallest negative delay that is less than source1 period.
- The smallest absolute value of delay.

The :MEASure:DElay? query will make the measurement using the edges specified by the :MEASure:DEFine command.

Query Syntax :MEASure:DElay? [<source1>][,<source2>]

The :MEASure:DElay? query measures and returns the delay between source1 and source2. The delay measurement is made from the user-defined slope and edge count of the signal connected to source1, to the defined slope and edge count of the signal connected to source2. Delay measurement slope and edge parameters are selected using the :MEASure:DEFine command.

Also in the :MEASure:DEFine command, you can set upper, middle, and lower threshold values. *It is the middle threshold value that is used when performing the delay query.* The standard upper, middle, and lower measurement thresholds are 90%, 50%, and 10% values between Vbase and

5 Commands by Subsystem

Vtop. If you want to move the delay measurement point nearer to Vtop or Vbase, you must change the threshold values with the :MEASure:DEFine THResholds command.

Return Format <value><NL>

<value> ::= floating-point number delay time in seconds in NR3 format

- See Also**
- ["Introduction to :MEASure Commands"](#) on page 300
 - [":MEASure:DEFine"](#) on page 304
 - [":MEASure:PHASe"](#) on page 316

:MEASure:DUTYcycle

C (see [page 740](#))

Command Syntax :MEASure:DUTYcycle [<source>]
 <source> ::= {<digital channels> | CHANnel<n> | FUNction | MATH}
 <digital channels> ::= DIGital0,...,DIGital15 for the MSO models
 <n> ::= {1 | 2 | 3 | 4} for the four channel oscilloscope models
 <n> ::= {1 | 2} for the two channel oscilloscope models

The :MEASure:DUTYcycle command installs a screen measurement and starts a duty cycle measurement on the current :MEASure:SOURce. If the optional source parameter is specified, the current source is modified.

NOTE

The signal must be displayed to make the measurement. This command is not available if the source is FFT (Fast Fourier Transform).

Query Syntax :MEASure:DUTYcycle? [<source>]

The :MEASure:DUTYcycle? query measures and outputs the duty cycle of the signal specified by the :MEASure:SOURce command. The value returned for the duty cycle is the ratio of the positive pulse width to the period. The positive pulse width and the period of the specified signal are measured, then the duty cycle is calculated with the following formula:

$$\text{duty cycle} = (+\text{pulse width}/\text{period}) * 100$$

Return Format <value><NL>
 <value> ::= ratio of positive pulse width to period in NR3 format

- See Also**
- "[Introduction to :MEASure Commands](#)" on page 300
 - "[:MEASure:PERiod](#)" on page 315
 - "[:MEASure:PWIDth](#)" on page 318
 - "[:MEASure:SOURce](#)" on page 325

- Example Code**
- "[Example Code](#)" on page 326

:MEASure:FALLtime

C (see [page 740](#))

Command Syntax :MEASure:FALLtime [<source>]

<source> ::= {CHANnel<n> | FUNCTION | MATH}

<n> ::= {1 | 2 | 3 | 4} for the four channel oscilloscope models

<n> ::= {1 | 2} for the two channel oscilloscope models

The :MEASure:FALLtime command installs a screen measurement and starts a fall-time measurement. For highest measurement accuracy, set the sweep speed as fast as possible, while leaving the falling edge of the waveform on the display. If the optional source parameter is specified, the current source is modified.

NOTE

This command is not available if the source is FFT (Fast Fourier Transform).

Query Syntax :MEASure:FALLtime? [<source>]

The :MEASure:FALLtime? query measures and outputs the fall time of the displayed falling (negative-going) edge closest to the trigger reference. The fall time is determined by measuring the time at the upper threshold of the falling edge, then measuring the time at the lower threshold of the falling edge, and calculating the fall time with the following formula:

$$\text{fall time} = \text{time at lower threshold} - \text{time at upper threshold}$$

Return Format <value><NL>

<value> ::= time in seconds between the lower threshold and upper threshold in NR3 format

- See Also**
- "[Introduction to :MEASure Commands](#)" on page 300
 - "[:MEASure:RISetime](#)" on page 322
 - "[:MEASure:SOURce](#)" on page 325

:MEASure:FREQuency

C (see [page 740](#))

Command Syntax :MEASure:FREQuency [<source>]
 <source> ::= {<digital channels> | CHANnel<n> | FUNction | MATH}
 <digital channels> ::= DIGital0,...,DIGital15 for the MSO models
 <n> ::= {1 | 2 | 3 | 4} for the four channel oscilloscope models
 <n> ::= {1 | 2} for the two channel oscilloscope models

The :MEASure:FREQuency command installs a screen measurement and starts a frequency measurement. If the optional source parameter is specified, the current source is modified.

IF the edge on the screen closest to the trigger reference is rising:

THEN frequency = 1/(time at trailing rising edge - time at leading rising edge)

ELSE frequency = 1/(time at trailing falling edge - time at leading falling edge)

NOTE

This command is not available if the source is FFT (Fast Fourier Transform).

Query Syntax :MEASure:FREQuency? [<source>]

The :MEASure:FREQuency? query measures and outputs the frequency of the cycle on the screen closest to the trigger reference.

Return Format <source><NL>
 <source> ::= frequency in Hertz in NR3 format

- See Also**
- ["Introduction to :MEASure Commands"](#) on page 300
 - [":MEASure:SOURce"](#) on page 325
 - [":MEASure:PERiod"](#) on page 315

Example Code • ["Example Code"](#) on page 326

:MEASure:NWIDth

C (see [page 740](#))

Command Syntax :MEASure:NWIDth [<source>]
 <source> ::= {<digital channels> | CHANnel<n> | FUNction | MATH}
 <digital channels> ::= DIGital0,...,DIGital15 for the MSO models
 <n> ::= {1 | 2 | 3 | 4} for the four channel oscilloscope models
 <n> ::= {1 | 2} for the two channel oscilloscope models

The :MEASure:NWIDth command installs a screen measurement and starts a negative pulse width measurement. If the optional source parameter is specified, the current source is modified.

NOTE

This command is not available if the source is FFT (Fast Fourier Transform).

Query Syntax :MEASure:NWIDth? [<source>]

The :MEASure:NWIDth? query measures and outputs the width of the negative pulse on the screen closest to the trigger reference using the midpoint between the upper and lower thresholds.

FOR the negative pulse closest to the trigger point:

$$\text{width} = (\text{time at trailing rising edge} - \text{time at leading falling edge})$$

Return Format <value><NL>
 <value> ::= negative pulse width in seconds in NR3 format

- See Also**
- ["Introduction to :MEASure Commands"](#) on page 300
 - [":MEASure:SOURce"](#) on page 325
 - [":MEASure:PWIDth"](#) on page 318
 - [":MEASure:PERiod"](#) on page 315

:MEASure:OVERshoot

C (see [page 740](#))

Command Syntax :MEASure:OVERshoot [<source>]

<source> ::= {CHANnel<n> | FUNCTION | MATH}

<n> ::= {1 | 2 | 3 | 4} for the four channel oscilloscope models

<n> ::= {1 | 2} for the two channel oscilloscope models

The :MEASure:OVERshoot command installs a screen measurement and starts an overshoot measurement. If the optional source parameter is specified, the current source is modified.

NOTE

This command is not available if the source is FFT (Fast Fourier Transform).

Query Syntax :MEASure:OVERshoot? [<source>]

The :MEASure:OVERshoot? query measures and returns the overshoot of the edge closest to the trigger reference, displayed on the screen. The method used to determine overshoot is to make three different vertical value measurements: Vtop, Vbase, and either Vmax or Vmin, depending on whether the edge is rising or falling.

For a rising edge:

$$\text{overshoot} = ((V_{\text{max}} - V_{\text{top}}) / (V_{\text{top}} - V_{\text{base}})) \times 100$$

For a falling edge:

$$\text{overshoot} = ((V_{\text{base}} - V_{\text{min}}) / (V_{\text{top}} - V_{\text{base}})) \times 100$$

Vtop and Vbase are taken from the normal histogram of all waveform vertical values. The extremum of Vmax or Vmin is taken from the waveform interval right after the chosen edge, halfway to the next edge. This more restricted definition is used instead of the normal one, because it is conceivable that a signal may have more preshoot than overshoot, and the normal extremum would then be dominated by the preshoot of the following edge.

Return Format <overshoot><NL>

<overshoot> ::= the percent of the overshoot of the selected waveform in NR3 format

- See Also**
- ["Introduction to :MEASure Commands"](#) on page 300
 - [":MEASure:PREShoot"](#) on page 317
 - [":MEASure:SOURce"](#) on page 325
 - [":MEASure:VMAX"](#) on page 337

5 Commands by Subsystem

- `":MEASure:VTOP"` on page 343
- `":MEASure:VBASe"` on page 336
- `":MEASure:VMIN"` on page 338

:MEASure:PERiod

C (see [page 740](#))

Command Syntax :MEASure:PERiod [<source>]
 <source> ::= {<digital channels> | CHANnel<n> | FUNction | MATH}
 <digital channels> ::= DIGital0,...,DIGital15 for the MSO models
 <n> ::= {1 | 2 | 3 | 4} for the four channel oscilloscope models
 <n> ::= {1 | 2} for the two channel oscilloscope models

The :MEASure:PERiod command installs a screen measurement and starts the period measurement. If the optional source parameter is specified, the current source is modified.

NOTE

This command is not available if the source is FFT (Fast Fourier Transform).

Query Syntax :MEASure:PERiod? [<source>]

The :MEASure:PERiod? query measures and outputs the period of the cycle closest to the trigger reference on the screen. The period is measured at the midpoint of the upper and lower thresholds.

IF the edge closest to the trigger reference on screen is rising:

THEN period = (time at trailing rising edge - time at leading rising edge)

ELSE period = (time at trailing falling edge - time at leading falling edge)

Return Format <value><NL>
 <value> ::= waveform period in seconds in NR3 format

- See Also**
- ["Introduction to :MEASure Commands"](#) on page 300
 - [":MEASure:SOURce"](#) on page 325
 - [":MEASure:NWIDTH"](#) on page 312
 - [":MEASure:PWIDth"](#) on page 318
 - [":MEASure:FREQuency"](#) on page 311

Example Code • ["Example Code"](#) on page 326

:MEASure:PHASe

N (see [page 740](#))

Command Syntax :MEASure:PHASe [<source1>][,<source2>]
 <source1>, <source2> ::= {CHANnel<n> | FUNction | MATH}
 <n> ::= {1 | 2 | 3 | 4} for the four channel oscilloscope models
 <n> ::= {1 | 2} for the two channel oscilloscope models

The :MEASure:PHASe command places the instrument in the continuous measurement mode and starts a phase measurement.

Query Syntax :MEASure:PHASe? [<source1>][,<source2>]

The :MEASure:PHASe? query measures and returns the phase between the specified sources.

A phase measurement is a combination of the period and delay measurements. First, the period is measured on source1. Then the delay is measured between source1 and source2. The edges used for delay are the source1 rising edge used for the period measurement closest to the horizontal reference and the rising edge on source 2. See :MEASure:DELAy for more detail on selecting the 2nd edge.

The phase is calculated as follows:

$$\text{phase} = (\text{delay} / \text{period of input 1}) \times 360$$

Return Format <value><NL>
 <value> ::= the phase angle value in degrees in NR3 format

- See Also**
- ["Introduction to :MEASure Commands"](#) on page 300
 - [":MEASure:DELAy"](#) on page 307
 - [":MEASure:PERiod"](#) on page 315
 - [":MEASure:SOURce"](#) on page 325

:MEASure:PREShoot

C (see [page 740](#))

Command Syntax :MEASure:PREShoot [<source>]

<source> ::= {CHANnel<n> | FUNCTION | MATH}

<n> ::= {1 | 2 | 3 | 4} for the four channel oscilloscope models

<n> ::= {1 | 2} for the two channel oscilloscope models

The :MEASure:PREShoot command installs a screen measurement and starts a preshoot measurement. If the optional source parameter is specified, the current source is modified.

Query Syntax :MEASure:PREShoot? [<source>]

The :MEASure:PREShoot? query measures and returns the preshoot of the edge closest to the trigger, displayed on the screen. The method used to determine preshoot is to make three different vertical value measurements: Vtop, Vbase, and either Vmin or Vmax, depending on whether the edge is rising or falling.

For a rising edge:

$$\text{preshoot} = ((V_{\text{min}} - V_{\text{base}}) / (V_{\text{top}} - V_{\text{base}})) \times 100$$

For a falling edge:

$$\text{preshoot} = ((V_{\text{max}} - V_{\text{top}}) / (V_{\text{top}} - V_{\text{base}})) \times 100$$

Vtop and Vbase are taken from the normal histogram of all waveform vertical values. The extremum of Vmax or Vmin is taken from the waveform interval right before the chosen edge, halfway back to the previous edge. This more restricted definition is used instead of the normal one, because it is likely that a signal may have more overshoot than preshoot, and the normal extremum would then be dominated by the overshoot of the preceding edge.

Return Format <value><NL>

<value> ::= the percent of preshoot of the selected waveform
in NR3 format

- See Also**
- ["Introduction to :MEASure Commands"](#) on page 300
 - [":MEASure:SOURce"](#) on page 325
 - [":MEASure:VMIN"](#) on page 338
 - [":MEASure:VMAX"](#) on page 337
 - [":MEASure:VTOP"](#) on page 343
 - [":MEASure:VBASe"](#) on page 336

:MEASure:PWIDth

C (see [page 740](#))

Command Syntax :MEASure:PWIDth [<source>]
 <source> ::= {<digital channels> | CHANnel<n> | FUNction | MATH}
 <digital channels> ::= DIGital0,...,DIGital15 for the MSO models
 <n> ::= {1 | 2 | 3 | 4} for the four channel oscilloscope models
 <n> ::= {1 | 2} for the two channel oscilloscope models

The :MEASure:PWIDth command installs a screen measurement and starts the positive pulse width measurement. If the optional source parameter is specified, the current source is modified.

NOTE

This command is not available if the source is FFT (Fast Fourier Transform).

Query Syntax :MEASure:PWIDth? [<source>]

The :MEASure:PWIDth? query measures and outputs the width of the displayed positive pulse closest to the trigger reference. Pulse width is measured at the midpoint of the upper and lower thresholds.

IF the edge on the screen closest to the trigger is falling:

THEN width = (time at trailing falling edge - time at leading rising edge)

ELSE width = (time at leading falling edge - time at leading rising edge)

Return Format <value><NL>
 <value> ::= width of positive pulse in seconds in NR3 format

- See Also**
- ["Introduction to :MEASure Commands"](#) on page 300
 - [":MEASure:SOURce"](#) on page 325
 - [":MEASure:NWIDth"](#) on page 312
 - [":MEASure:PERiod"](#) on page 315

:MEASure:RESults

N (see [page 740](#))

Query Syntax :MEASure:RESults?

The :MEASure:RESults? query returns the results of the continuously displayed measurements. The response to the MEASure:RESults? query is a list of comma-separated values.

If more than one measurement is running continuously, the :MEASure:RESults return values are duplicated for each continuous measurement from the first to last (left to right) result displayed. Each result returned is separated from the previous result by a comma. There is a maximum of four continuous measurements that can be continuously displayed at a time.

When no quick measurements are installed, the :MEASure:RESults? query returns nothing (empty string). When the count for any of the measurements is 0, the value of infinity (9.9E+37) is returned for the min, max, mean, and standard deviation.

Return Format <result_list><NL>

<result_list> ::= comma-separated list of measurement results

The following shows the order of values received for a single measurement if :MEASure:STATistics is set to ON.

Measurement label	current	min	max	mean	std dev	count
-------------------	---------	-----	-----	------	---------	-------

Measurement label, current, min, max, mean, std dev, and count are only returned if :MEASure:STATistics is ON.

If :MEASure:STATistics is set to CURRENT, MIN, MAX, MEAN, STDDDev, or COUNT only that particular statistic value is returned for each measurement that is on.

- See Also**
- ["Introduction to :MEASure Commands"](#) on page 300
 - [":MEASure:STATistics"](#) on page 327

Example Code

```
' This program shows the InfiniiVision oscilloscopes' measurement
' statistics commands.
' -----

Option Explicit

Public myMgr As VisaComLib.ResourceManager
Public myScope As VisaComLib.FormattedIO488
Public varQueryResult As Variant
Public strQueryResult As String
```

5 Commands by Subsystem

```
Private Declare Sub Sleep Lib "kernel32" (ByVal dwMilliseconds As Long)

Sub Main()

    On Error GoTo VisaComError

    ' Create the VISA COM I/O resource.
    Set myMgr = New VisaComLib.ResourceManager
    Set myScope = New VisaComLib.FormattedIO488
    Set myScope.IO = myMgr.Open("TCPIP0::130.29.70.228::inst0::INSTR")

    ' Initialize.
    myScope.IO.Clear ' Clear the interface.
    myScope.WriteString "*RST" ' Reset to the defaults.
    myScope.WriteString "*CLS" ' Clear the status data structures.
    myScope.WriteString ":AUToscale"

    ' Install some measurements.
    myScope.WriteString ":MEASure:SOURce CHANnel1" ' Input source.

    Dim MeasurementArray(3) As String
    MeasurementArray(0) = "FREQuency"
    MeasurementArray(1) = "DUTYcycle"
    MeasurementArray(2) = "VAMPLitude"
    MeasurementArray(3) = "VPP"
    Dim Measurement As Variant

    For Each Measurement In MeasurementArray
        myScope.WriteString ":MEASure:" + Measurement
        myScope.WriteString ":MEASure:" + Measurement + "?"
        varQueryResult = myScope.ReadNumber ' Read measurement value.
        Debug.Print Measurement + ": " + FormatNumber(varQueryResult, 4)
    Next

    myScope.WriteString ":MEASure:STATistics:RESet" ' Reset stats.
    Sleep 5000 ' Wait for 5 seconds.

    ' Select the statistics results type.
    Dim ResultsTypeArray(6) As String
    ResultsTypeArray(0) = "CURRent"
    ResultsTypeArray(1) = "MINimum"
    ResultsTypeArray(2) = "MAXimum"
    ResultsTypeArray(3) = "MEAN"
    ResultsTypeArray(4) = "STDDev"
    ResultsTypeArray(5) = "COUNT"
    ResultsTypeArray(6) = "ON" ' All results.
    Dim ResultType As Variant

    Dim ResultsList()

    Dim ValueColumnArray(6) As String
    ValueColumnArray(0) = "Meas_Lbl"
    ValueColumnArray(1) = "Current"
    ValueColumnArray(2) = "Min"
    ValueColumnArray(3) = "Max"
    ValueColumnArray(4) = "Mean"
```



```

ValueColumnArray(5) = "Std_Dev"
ValueColumnArray(6) = "Count"
Dim ValueColumn As Variant

For Each ResultType In ResultsTypeArray
    myScope.WriteString ":MEASure:STATistics " + ResultType

    ' Get the statistics results.
    Dim intCounter As Integer
    intCounter = 0
    myScope.WriteString ":MEASure:RESults?"
    ResultsList() = myScope.ReadList

    For Each Measurement In MeasurementArray

        If ResultType = "ON" Then ' All statistics.

            For Each ValueColumn In ValueColumnArray
                If VarType(ResultsList(intCounter)) <> vbString Then
                    Debug.Print "Measure statistics result CH1, " + _
                        Measurement + ", "; ValueColumn + ": " + _
                        FormatNumber(ResultsList(intCounter), 4)

                Else ' Result is a string (e.g., measurement label).
                    Debug.Print "Measure statistics result CH1, " + _
                        Measurement + ", "; ValueColumn + ": " + _
                        ResultsList(intCounter)

                End If

                intCounter = intCounter + 1

            Next

        Else ' Specific statistic (e.g., Current, Max, Min, etc.).

            Debug.Print "Measure statistics result CH1, " + _
                Measurement + ", "; ResultType + ": " + _
                FormatNumber(ResultsList(intCounter), 4)

            intCounter = intCounter + 1

        End If

    Next

Next

Exit Sub

VisaComError:
    MsgBox "VISA COM Error:" + vbCrLf + Err.Description

End Sub

```

:MEASure:RISetime

C (see [page 740](#))

Command Syntax :MEASure: RISetime [<source>]

<source> ::= {CHANnel<n> | FUNction | MATH}

<n> ::= {1 | 2 | 3 | 4} for the four channel oscilloscope models

<n> ::= {1 | 2} for the two channel oscilloscope models

The :MEASure:RISetime command installs a screen measurement and starts a rise-time measurement. If the optional source parameter is specified, the current source is modified.

NOTE

This command is not available if the source is FFT (Fast Fourier Transform).

Query Syntax :MEASure: RISetime? [<source>]

The :MEASure:RISetime? query measures and outputs the rise time of the displayed rising (positive-going) edge closest to the trigger reference. For maximum measurement accuracy, set the sweep speed as fast as possible while leaving the leading edge of the waveform on the display. The rise time is determined by measuring the time at the lower threshold of the rising edge and the time at the upper threshold of the rising edge, then calculating the rise time with the following formula:

$$\text{rise time} = \text{time at upper threshold} - \text{time at lower threshold}$$

Return Format <value><NL>

<value> ::= rise time in seconds in NR3 format

- See Also**
- ["Introduction to :MEASure Commands"](#) on page 300
 - [":MEASure:SOURce"](#) on page 325
 - [":MEASure:FALLtime"](#) on page 310

:MEASure:SDEVIation

N (see [page 740](#))

Command Syntax :MEASure:SDEVIation [<source>]

<source> ::= {CHANnel<n> | FUNction | MATH}

<n> ::= {1 | 2 | 3 | 4} for the four channel oscilloscope models

<n> ::= {1 | 2} for the two channel oscilloscope models

The :MEASure:SDEVIation command installs a screen measurement and starts std deviation measurement. If the optional source parameter is specified, the current source is modified.

NOTE

This command is not available if the source is FFT (Fast Fourier Transform).

Query Syntax :MEASure:SDEVIation? [<source>]

The :MEASure:SDEVIation? query measures and outputs the std deviation of the selected waveform. The oscilloscope computes the std deviation on all displayed data points.

Return Format <value><NL>

<value> ::= calculated std deviation value in NR3 format

- See Also**
- ["Introduction to :MEASure Commands"](#) on page 300
 - [":MEASure:SOURce"](#) on page 325

:MEASure:SHOW

N (see [page 740](#))

Command Syntax :MEASure:SHOW <show>
<show> ::= {1 | ON}

The :MEASure:SHOW command enables markers for tracking measurements on the display. This feature is always on.

Query Syntax :MEASure:SHOW?

The :MEASure:SHOW? query returns the current state of the markers.

Return Format <show><NL>
<show> ::= 1

See Also • ["Introduction to :MEASure Commands"](#) on page 300

:MEASure:SOURce

C (see [page 740](#))

Command Syntax :MEASure:SOURce <source1>[,<source2>]

<source1>,<source2> ::= {<digital channels> | CHANnel<n> | FUNcTion
| MATH | EXTErnal}

<digital channels> ::= DIGital0,...,DIGital15 for the MSO models

<n> ::= {1 | 2 | 3 | 4} for the four channel oscilloscope models

<n> ::= {1 | 2} for the two channel oscilloscope models

The :MEASure:SOURce command sets the default sources for measurements. The specified sources are used as the sources for the MEASure subsystem commands if the sources are not explicitly set with the command.

If a source is specified for any measurement, the current source is changed to this new value.

If :MARKer:MODE is set to OFF or MANual, setting :MEASure:SOURce to CHANnel<n>, FUNcTion, or MATH will also set :MARKer:X1Y1source to source1 and :MARKer:X2Y2source to source2.

EXTErnal is only a valid source for the counter measurement (and <source1>).

Query Syntax :MEASure:SOURce?

The :MEASure:SOURce? query returns the current source selections. If source2 is not specified, the query returns "NONE" for source2. If all channels are off, the query returns "NONE,NONE". Source2 only applies to :MEASure:DELAy and :MEASure:PHASe measurements.

NOTE

MATH is an alias for FUNcTion. The query will return FUNC if the source is FUNcTion or MATH.

Return Format <source1>,<source2><NL>

<source1>,<source2> ::= {<digital channels> | CHAN<n> | FUNC | EXT
| NONE}

- See Also:**
- ["Introduction to :MEASure Commands"](#) on page 300
 - [":MARKer:MODE"](#) on page 285
 - [":MARKer:X1Y1source"](#) on page 287
 - [":MARKer:X2Y2source"](#) on page 289
 - [":MEASure:DELAy"](#) on page 307
 - [":MEASure:PHASe"](#) on page 316

Example Code

```
' MEASURE - The commands in the MEASURE subsystem are used to make
' measurements on displayed waveforms.
myScope.WriteString ":MEASURE:SOURCE CHANNEL1" ' Source to measure.
myScope.WriteString ":MEASURE:FREQUENCY?" ' Query for frequency.
varQueryResult = myScope.ReadNumber ' Read frequency.
MsgBox "Frequency:" + vbCrLf _
    + FormatNumber(varQueryResult / 1000, 4) + " kHz"
myScope.WriteString ":MEASURE:DUTYCYCLE?" ' Query for duty cycle.
varQueryResult = myScope.ReadNumber ' Read duty cycle.
MsgBox "Duty cycle:" + vbCrLf _
    + FormatNumber(varQueryResult, 3) + "%"
myScope.WriteString ":MEASURE:RISETIME?" ' Query for risetime.
varQueryResult = myScope.ReadNumber ' Read risetime.
MsgBox "Risetime:" + vbCrLf _
    + FormatNumber(varQueryResult * 1000000, 4) + " us"
myScope.WriteString ":MEASURE:VPP?" ' Query for Pk to Pk voltage.
varQueryResult = myScope.ReadNumber ' Read VPP.
MsgBox "Peak to peak voltage:" + vbCrLf _
    + FormatNumber(varQueryResult, 4) + " V"
myScope.WriteString ":MEASURE:VMAX?" ' Query for Vmax.
varQueryResult = myScope.ReadNumber ' Read Vmax.
MsgBox "Maximum voltage:" + vbCrLf _
    + FormatNumber(varQueryResult, 4) + " V"
```

Example program from the start: ["VISA COM Example in Visual Basic"](#) on page 828

:MEASure:STATistics

N (see [page 740](#))

Command Syntax :MEASure:STATistics <type>

```
<type> ::= {{ON | 1} | CURRent | MINimum | MAXimum | MEAN | STDDev
           | COUNT}
```

The :MEASure:STATistics command determines the type of information returned by the :MEASure:RESults? query. ON means all the statistics are on.

Query Syntax :MEASure:STATistics?

The :MEASure:STATistics? query returns the current statistics mode.

Return Format <type><NL>

```
<type> ::= {ON | CURR | MIN | MAX | MEAN | STDD | COUN}
```

- See Also**
- ["Introduction to :MEASure Commands"](#) on page 300
 - [":MEASure:RESults"](#) on page 319
 - [":MEASure:STATistics:RESet"](#) on page 329
 - [":MEASure:STATistics:INCRement"](#) on page 328

Example Code • ["Example Code"](#) on page 319

:MEASure:STATistics:INCRement

N (see [page 740](#))

Command Syntax :MEASure:STATistics:INCRement

This command updates the statistics once (incrementing the count by one) using the current measurement values. It corresponds to the front panel **Increment Statistics** softkey in the Measurement Statistics Menu. This command lets you, for example, gather statistics over multiple pulses captured in a single acquisition. To do this, change the horizontal position and enter the command for each new pulse that is measured.

This command is only allowed when the oscilloscope is stopped and quick measurements are on.

The command is allowed in segmented acquisition mode even though the corresponding front panel softkey is not available.

- See Also**
- "[Introduction to :MEASure Commands](#)" on page 300
 - "[:MEASure:STATistics](#)" on page 327
 - "[:MEASure:STATistics:RESet](#)" on page 329
 - "[:MEASure:RESults](#)" on page 319

:MEASure:STATistics:RESet

N (see [page 740](#))

Command Syntax :MEASure:STATistics:RESet

This command resets the measurement statistics, zeroing the counts.

Note that the measurement (statistics) configuration is not deleted.

- See Also**
- ["Introduction to :MEASure Commands"](#) on page 300
 - [":MEASure:STATistics"](#) on page 327
 - [":MEASure:RESults"](#) on page 319
 - [":MEASure:STATistics:INCRement"](#) on page 328

- Example Code**
- ["Example Code"](#) on page 319

:MEASure:TEDGe

N (see [page 740](#))

Query Syntax :MEASure:TEDGe? <slope><occurrence>[,<source>]

<slope> ::= direction of the waveform. A rising slope is indicated by a space or plus sign (+). A falling edge is indicated by a minus sign (-).

<occurrence> ::= the transition to be reported. If the occurrence number is one, the first crossing from the left screen edge is reported. If the number is two, the second crossing is reported, etc.

<source> ::= {<digital channels> | CHANnel<n> | FUNction | MATH}

<digital channels> ::= DIGital0,...,DIGital15 for the MSO models

<n> ::= {1 | 2 | 3 | 4} for the four channel oscilloscope models

<n> ::= {1 | 2} for the two channel oscilloscope models

When the :MEASure:TEDGe query is sent, the displayed signal is searched for the specified transition. The time interval between the trigger event and this occurrence is returned as the response to the query. The sign of the slope selects a rising (+) or falling (-) edge. If no sign is specified for the slope, it is assumed to be the rising edge.

The magnitude of occurrence defines the occurrence to be reported. For example, +3 returns the time for the third time the waveform crosses the midpoint threshold in the positive direction. Once this crossing is found, the oscilloscope reports the time at that crossing in seconds, with the trigger point (time zero) as the reference.

If the specified crossing cannot be found, the oscilloscope reports +9.9E+37. This value is returned if the waveform does not cross the specified vertical value, or if the waveform does not cross the specified vertical value for the specific number of times in the direction specified.

You can make delay and phase measurements using the MEASure:TEDGe command:

Delay = time at the nth rising or falling edge of the channel - time at the same edge of another channel

Phase = (delay between channels / period of channel) x 360

For an example of making a delay and phase measurement, see "[:MEASure:TEDGe Code](#)" on page 331.

If the optional source parameter is specified, the current source is modified.

NOTE

This query is not available if the source is FFT (Fast Fourier Transform).

Return Format

<value><NL>

<value> ::= time in seconds of the specified transition in NR3 format

**:MEASure:TEDGe
Code**

```
' Make a delay measurement between channel 1 and 2.
Dim dblChan1Edge1 As Double
Dim dblChan2Edge1 As Double
Dim dblChan1Edge2 As Double
Dim dblDelay As Double
Dim dblPeriod As Double
Dim dblPhase As Double

' Query time at 1st rising edge on ch1.
myScope.WriteString ":MEASURE:TEDGE? +1, CHAN1"

' Read time at edge 1 on ch 1.
dblChan1Edge1 = myScope.ReadNumber

' Query time at 1st rising edge on ch2.
myScope.WriteString ":MEASURE:TEDGE? +1, CHAN2"

' Read time at edge 1 on ch 2.
dblChan2Edge1 = myScope.ReadNumber

' Calculate delay time between ch1 and ch2.
dblDelay = dblChan2Edge1 - dblChan1Edge1

' Write calculated delay time to screen.
MsgBox "Delay = " + vbCrLf + CStr(dblDelay)

' Make a phase difference measurement between channel 1 and 2.
' Query time at 1st rising edge on ch1.
myScope.WriteString ":MEASURE:TEDGE? +2, CHAN1"

' Read time at edge 2 on ch 1.
dblChan1Edge2 = myScope.ReadNumber

' Calculate period of ch 1.
dblPeriod = dblChan1Edge2 - dblChan1Edge1

' Calculate phase difference between ch1 and ch2.
dblPhase = (dblDelay / dblPeriod) * 360
MsgBox "Phase = " + vbCrLf + CStr(dblPhase)
```

Example program from the start: ["VISA COM Example in Visual Basic"](#) on page 828

- See Also**
- ["Introduction to :MEASure Commands"](#) on page 300
 - [":MEASure:TVALue"](#) on page 332
 - [":MEASure:VTIME"](#) on page 342

:MEASure:TVALue

C (see page 740)

Query Syntax :MEASure:TVALue? <value>, [<slope>]<occurrence>[,<source>]

<value> ::= the vertical value that the waveform must cross. The value can be volts or a math function value such as dB, Vs, or V/s.

<slope> ::= direction of the waveform. A rising slope is indicated by a plus sign (+). A falling edge is indicated by a minus sign (-).

<occurrence> ::= the transition to be reported. If the occurrence number is one, the first crossing is reported. If the number is two, the second crossing is reported, etc.

<source> ::= {CHANnel<n> | FUNCTION | MATH}

<n> ::= {1 | 2 | 3 | 4} for the four channel oscilloscope models

<n> ::= {1 | 2} for the two channel oscilloscope models

When the :MEASure:TVALue? query is sent, the displayed signal is searched for the specified value level and transition. The time interval between the trigger event and this defined occurrence is returned as the response to the query.

The specified value can be negative or positive. To specify a negative value, use a minus sign (-). The sign of the slope selects a rising (+) or falling (-) edge. If no sign is specified for the slope, it is assumed to be the rising edge.

The magnitude of the occurrence defines the occurrence to be reported. For example, +3 returns the time for the third time the waveform crosses the specified value level in the positive direction. Once this value crossing is found, the oscilloscope reports the time at that crossing in seconds, with the trigger point (time zero) as the reference.

If the specified crossing cannot be found, the oscilloscope reports +9.9E+37. This value is returned if the waveform does not cross the specified value, or if the waveform does not cross the specified value for the specified number of times in the direction specified.

If the optional source parameter is specified, the current source is modified.

NOTE

This query is not available if the source is FFT (Fast Fourier Transform).

Return Format <value><NL>

<value> ::= time in seconds of the specified value crossing in
NR3 format

- See Also**
- ["Introduction to :MEASure Commands"](#) on page 300
 - [":MEASure:TEDGE"](#) on page 330
 - [":MEASure:VTIME"](#) on page 342

:MEASure:VAMPlitude

C (see [page 740](#))

Command Syntax :MEASure:VAMPlitude [<source>]

<source> ::= {CHANnel<n> | FUNction | MATH}

<n> ::= {1 | 2 | 3 | 4} for the four channel oscilloscope models

<n> ::= {1 | 2} for the two channel oscilloscope models

The :MEASure:VAMPlitude command installs a screen measurement and starts a vertical amplitude measurement. If the optional source parameter is specified, the current source is modified.

Query Syntax :MEASure:VAMPlitude? [<source>]

The :MEASure:VAMPlitude? query measures and returns the vertical amplitude of the waveform. To determine the amplitude, the instrument measures Vtop and Vbase, then calculates the amplitude as follows:

$$\text{vertical amplitude} = V_{\text{top}} - V_{\text{base}}$$

Return Format <value><NL>

<value> ::= the amplitude of the selected waveform in NR3 format

- See Also**
- "[Introduction to :MEASure Commands](#)" on [page 300](#)
 - "[:MEASure:SOURce](#)" on [page 325](#)
 - "[:MEASure:VBASe](#)" on [page 336](#)
 - "[:MEASure:VTOP](#)" on [page 343](#)
 - "[:MEASure:VPP](#)" on [page 339](#)

:MEASure:VAverage

C (see [page 740](#))

Command Syntax :MEASure:VAverage [<source>]

<source> ::= {CHANnel<n> | FUNCTION | MATH}

<n> ::= {1 | 2 | 3 | 4} for the four channel oscilloscope models

<n> ::= {1 | 2} for the two channel oscilloscope models

The :MEASure:VAverage command installs a screen measurement and starts an average value measurement. If the optional source parameter is specified, the current source is modified.

Query Syntax :MEASure:VAverage? [<source>]

The :MEASure:VAverage? query returns the average value of an integral number of periods of the signal. If at least three edges are not present, the oscilloscope averages all data points.

Return Format <value><NL>

<value> ::= calculated average value in NR3 format

- See Also**
- ["Introduction to :MEASure Commands"](#) on page 300
 - [":MEASure:SOURce"](#) on page 325

:MEASure:VBASe

C (see [page 740](#))

Command Syntax :MEASure:VBASe [<source>]

<source> ::= {CHANnel<n> | FUNCTION | MATH}

<n> ::= {1 | 2 | 3 | 4} for the four channel oscilloscope models

<n> ::= {1 | 2} for the two channel oscilloscope models

The :MEASure:VBASe command installs a screen measurement and starts a waveform base value measurement. If the optional source parameter is specified, the current source is modified.

NOTE

This command is not available if the source is FFT (Fast Fourier Transform).

Query Syntax :MEASure:VBASe? [<source>]

The :MEASure:VBASe? query returns the vertical value at the base of the waveform. The base value of a pulse is normally not the same as the minimum value.

Return Format <base_voltage><NL>

<base_voltage> ::= value at the base of the selected waveform in NR3 format

- See Also**
- "[Introduction to :MEASure Commands](#)" on page 300
 - "[:MEASure:SOURce](#)" on page 325
 - "[:MEASure:VTOP](#)" on page 343
 - "[:MEASure:VAMPLitude](#)" on page 334
 - "[:MEASure:VMIN](#)" on page 338

:MEASure:VMAX

C (see [page 740](#))

Command Syntax :MEASure:VMAX [<source>]

<source> ::= {CHANnel<n> | FUNCTION | MATH}

<n> ::= {1 | 2 | 3 | 4} for the four channel oscilloscope models

<n> ::= {1 | 2} for the two channel oscilloscope models

The :MEASure:VMAX command installs a screen measurement and starts a maximum vertical value measurement. If the optional source parameter is specified, the current source is modified.

Query Syntax :MEASure:VMAX? [<source>]

The :MEASure:VMAX? query measures and outputs the maximum vertical value present on the selected waveform.

Return Format <value><NL>

<value> ::= maximum vertical value of the selected waveform in NR3 format

- See Also**
- ["Introduction to :MEASure Commands"](#) on page 300
 - [":MEASure:SOURce"](#) on page 325
 - [":MEASure:VMIN"](#) on page 338
 - [":MEASure:VPP"](#) on page 339
 - [":MEASure:VTOP"](#) on page 343

:MEASure:VMIN

C (see [page 740](#))

Command Syntax :MEASure:VMIN [<source>]

<source> ::= {CHANnel<n> | FUNCTION | MATH}

<n> ::= {1 | 2 | 3 | 4} for the four channel oscilloscope models

<n> ::= {1 | 2} for the two channel oscilloscope models

The :MEASure:VMIN command installs a screen measurement and starts a minimum vertical value measurement. If the optional source parameter is specified, the current source is modified.

Query Syntax :MEASure:VMIN? [<source>]

The :MEASure:VMIN? query measures and outputs the minimum vertical value present on the selected waveform.

Return Format <value><NL>

<value> ::= minimum vertical value of the selected waveform in NR3 format

- See Also**
- ["Introduction to :MEASure Commands"](#) on page 300
 - [":MEASure:SOURce"](#) on page 325
 - [":MEASure:VBASe"](#) on page 336
 - [":MEASure:VMAX"](#) on page 337
 - [":MEASure:VPP"](#) on page 339

:MEASure:VPP

C (see [page 740](#))

Command Syntax :MEASure:VPP [<source>]

<source> ::= {CHANnel<n> | FUNCTION | MATH}

<n> ::= {1 | 2 | 3 | 4} for the four channel oscilloscope models

<n> ::= {1 | 2} for the two channel oscilloscope models

The :MEASure:VPP command installs a screen measurement and starts a vertical peak-to-peak measurement. If the optional source parameter is specified, the current source is modified.

Query Syntax :MEASure:VPP? [<source>]

The :MEASure:VPP? query measures the maximum and minimum vertical value for the selected source, then calculates the vertical peak-to-peak value and returns that value. The peak-to-peak value (Vpp) is calculated with the following formula:

$$V_{pp} = V_{max} - V_{min}$$

Vmax and Vmin are the vertical maximum and minimum values present on the selected source.

Return Format <value><NL>

<value> ::= vertical peak to peak value in NR3 format

- See Also**
- ["Introduction to :MEASure Commands"](#) on page 300
 - [":MEASure:SOURce"](#) on page 325
 - [":MEASure:VMAX"](#) on page 337
 - [":MEASure:VMIN"](#) on page 338
 - [":MEASure:VAMPLitude"](#) on page 334

:MEASure:VRATio

N (see [page 740](#))

Command Syntax :MEASure:VRATio [<source1>][,<source2>]

<source1>, <source2> ::= {CHANnel<n> | FUNction | MATH}

<n> ::= {1 | 2 | 3 | 4} for the four channel oscilloscope models

<n> ::= {1 | 2} for the two channel oscilloscope models

The :MEASure:VRATio command places the instrument in the continuous measurement mode and starts a ratio measurement.

Query Syntax :MEASure:VRATio? [<source1>][,<source2>]

The :MEASure:VRATio? query measures and returns the ratio of AC RMS values of the specified sources expressed as dB.

Return Format <value><NL>

<value> ::= the ratio value in dB in NR3 format

- See Also**
- ["Introduction to :MEASure Commands"](#) on page 300
 - [":MEASure:VRMS"](#) on page 341
 - [":MEASure:SOURce"](#) on page 325

:MEASure:VRMS

C (see [page 740](#))

Command Syntax :MEASure:VRMS [<source>]

<source> ::= {CHANnel<n> | FUNCTION | MATH}

<n> ::= {1 | 2 | 3 | 4} for the four channel oscilloscope models

<n> ::= {1 | 2} for the two channel oscilloscope models

The :MEASure:VRMS command installs a screen measurement and starts a dc RMS value measurement. If the optional source parameter is specified, the current source is modified.

NOTE

This command is not available if the source is FFT (Fast Fourier Transform).

Query Syntax :MEASure:VRMS? [<source>]

The :MEASure:VRMS? query measures and outputs the dc RMS value of the selected waveform. The dc RMS value is measured on an integral number of periods of the displayed signal. If at least three edges are not present, the oscilloscope computes the RMS value on all displayed data points.

Return Format <value><NL>

<value> ::= calculated dc RMS value in NR3 format

- See Also**
- "[Introduction to :MEASure Commands](#)" on page 300
 - "[:MEASure:SOURce](#)" on page 325

:MEASure:VTIME

N (see [page 740](#))

Query Syntax :MEASure:VTIME? <vtime_argument>[,<source>]
 <vtime_argument> ::= time from trigger in seconds
 <source> ::= {<digital channels> | CHANnel<n> | FUNction | MATH}
 <digital channels> ::= DIGital0,...,DIGital15 for the MSO models
 <n> ::= {1 | 2 | 3 | 4} for the four channel oscilloscope models
 <n> ::= {1 | 2} for the two channel oscilloscope models

The :MEASure:VTIME? query returns the value at a specified time on the source specified with :MEASure:SOURce. The specified time must be on the screen and is referenced to the trigger event. If the optional source parameter is specified, the current source is modified.

NOTE

This query is not available if the source is FFT (Fast Fourier Transform).

Return Format <value><NL>
 <value> ::= value at the specified time in NR3 format

- See Also**
- ["Introduction to :MEASure Commands"](#) on page 300
 - [":MEASure:SOURce"](#) on page 325
 - [":MEASure:TEDGe"](#) on page 330
 - [":MEASure:TVALue"](#) on page 332

:MEASure:VTOP

C (see [page 740](#))

Command Syntax :MEASure:VTOP [<source>]

<source> ::= {CHANnel<n> | FUNCTION | MATH}

<n> ::= {1 | 2 | 3 | 4} for the four channel oscilloscope models

<n> ::= {1 | 2} for the two channel oscilloscope models

The :MEASure:VTOP command installs a screen measurement and starts a waveform top value measurement.

NOTE

This query is not available if the source is FFT (Fast Fourier Transform).

Query Syntax :MEASure:VTOP? [<source>]

The :MEASure:VTOP? query returns the vertical value at the top of the waveform. The top value of the pulse is normally not the same as the maximum value.

Return Format <value><NL>

<value> ::= vertical value at the top of the waveform in NR3 format

- See Also**
- ["Introduction to :MEASure Commands"](#) on page 300
 - [":MEASure:SOURce"](#) on page 325
 - [":MEASure:VMAX"](#) on page 337
 - [":MEASure:VAMPLitude"](#) on page 334
 - [":MEASure:VBASe"](#) on page 336

:MEASure:XMAX

N (see [page 740](#))

Command Syntax :MEASure:XMAX [<source>]

<source> ::= {CHANnel<n> | FUNCTION | MATH}

<n> ::= {1 | 2 | 3 | 4} for the four channel oscilloscope models

<n> ::= {1 | 2} for the two channel oscilloscope models

The :MEASure:XMAX command installs a screen measurement and starts an X-at-Max-Y measurement on the selected window. If the optional source parameter is specified, the current source is modified.

NOTE

:MEASure:XMAX is an alias for :MEASure:TMAX.

Query Syntax :MEASure:XMAX? [<source>]

The :MEASure:XMAX? query measures and returns the horizontal axis value at which the maximum vertical value occurs. If the optional source is specified, the current source is modified. If all channels are off, the query returns 9.9E+37.

Return Format <value><NL>

<value> ::= horizontal value of the maximum in NR3 format

- See Also**
- ["Introduction to :MEASure Commands"](#) on page 300
 - [":MEASure:XMIN"](#) on page 345
 - [":MEASure:TMAX"](#) on page 670

:MEASure:XMIn

N (see [page 740](#))

Command Syntax :MEASure:XMIn [<source>]

<source> ::= {CHANnel<n> | FUNction | MATH}

<n> ::= {1 | 2 | 3 | 4} for the four channel oscilloscope models

<n> ::= {1 | 2} for the two channel oscilloscope models

The :MEASure:XMIn command installs a screen measurement and starts an X-at-Min-Y measurement on the selected window. If the optional source parameter is specified, the current source is modified.

NOTE

:MEASure:XMIn is an alias for :MEASure:TMin.

Query Syntax :MEASure:XMIn? [<source>]

The :MEASure:XMIn? query measures and returns the horizontal axis value at which the minimum vertical value occurs. If the optional source is specified, the current source is modified. If all channels are off, the query returns 9.9E+37.

Return Format <value><NL>

<value> ::= horizontal value of the minimum in NR3 format

- See Also**
- ["Introduction to :MEASure Commands"](#) on page 300
 - [":MEASure:XMIn"](#) on page 344
 - [":MEASure:TMin"](#) on page 671

:MTESt Commands

The MTESt subsystem commands and queries control the mask test features. See "[Introduction to :MTESt Commands](#)" on page 348.

Table 64 :MTESt Commands Summary

Command	Query	Options and Query Returns
:MTESt:AMASk:CREate (see page 351)	n/a	n/a
:MTESt:AMASk:SOURce <source> (see page 352)	:MTESt:AMASk:SOURce? (see page 352)	<source> ::= CHANnel<n> <n> ::= {1 2 3 4} for 4ch models <n> ::= {1 2} for 2ch models
:MTESt:AMASk:UNITs <units> (see page 353)	:MTESt:AMASk:UNITs? (see page 353)	<units> ::= {CURRent DIVisions}
:MTESt:AMASk:XDELta <value> (see page 354)	:MTESt:AMASk:XDELta? (see page 354)	<value> ::= X delta value in NR3 format
:MTESt:AMASk:YDELta <value> (see page 355)	:MTESt:AMASk:YDELta? (see page 355)	<value> ::= Y delta value in NR3 format
n/a	:MTESt:COUNt:FwAVeformS? [CHANnel<n>] (see page 356)	<failed> ::= number of failed waveforms in NR1 format
:MTESt:COUNt:RESet (see page 357)	n/a	n/a
n/a	:MTESt:COUNt:TIME? (see page 358)	<time> ::= elapsed seconds in NR3 format
n/a	:MTESt:COUNt:WAVEformS? (see page 359)	<count> ::= number of waveforms in NR1 format
:MTESt:DATA <mask> (see page 360)	:MTESt:DATA? (see page 360)	<mask> ::= data in IEEE 488.2 # format.
:MTESt:DELeTe (see page 361)	n/a	n/a
:MTESt:ENABle {{0 OFF} {1 ON}} (see page 362)	:MTESt:ENABle? (see page 362)	{0 1}
:MTESt:LOCK {{0 OFF} {1 ON}} (see page 363)	:MTESt:LOCK? (see page 363)	{0 1}

Table 64 :MTESt Commands Summary (continued)

Command	Query	Options and Query Returns
:MTESt:OUTPut <signal> (see page 364)	:MTESt:OUTPut? (see page 364)	<signal> ::= {FAIL PASS}
:MTESt:RMODe <rmode> (see page 365)	:MTESt:RMODe? (see page 365)	<rmode> ::= {FORever TIME SIGMa WAVeforms}
:MTESt:RMODe:FACTion: PRINT {{0 OFF} {1 ON}} (see page 366)	:MTESt:RMODe:FACTion: PRINT? (see page 366)	{0 1}
:MTESt:RMODe:FACTion: SAVE {{0 OFF} {1 ON}} (see page 367)	:MTESt:RMODe:FACTion: SAVE? (see page 367)	{0 1}
:MTESt:RMODe:FACTion: STOP {{0 OFF} {1 ON}} (see page 368)	:MTESt:RMODe:FACTion: STOP? (see page 368)	{0 1}
:MTESt:RMODe:SIGMa <level> (see page 369)	:MTESt:RMODe:SIGMa? (see page 369)	<level> ::= from 0.1 to 9.3 in NR3 format
:MTESt:RMODe:TIME <seconds> (see page 370)	:MTESt:RMODe:TIME? (see page 370)	<seconds> ::= from 1 to 86400 in NR3 format
:MTESt:RMODe:WAVeform s <count> (see page 371)	:MTESt:RMODe:WAVeform s? (see page 371)	<count> ::= number of waveforms in NR1 format
:MTESt:SCALe:BIND {{0 OFF} {1 ON}} (see page 372)	:MTESt:SCALe:BIND? (see page 372)	{0 1}
:MTESt:SCALe:X1 <x1_value> (see page 373)	:MTESt:SCALe:X1? (see page 373)	<x1_value> ::= X1 value in NR3 format
:MTESt:SCALe:XDELta <xdelta_value> (see page 374)	:MTESt:SCALe:XDELta? (see page 374)	<xdelta_value> ::= X delta value in NR3 format
:MTESt:SCALe:Y1 <y1_value> (see page 375)	:MTESt:SCALe:Y1? (see page 375)	<y1_value> ::= Y1 value in NR3 format
:MTESt:SCALe:Y2 <y2_value> (see page 376)	:MTESt:SCALe:Y2? (see page 376)	<y2_value> ::= Y2 value in NR3 format

Table 64 :MTESt Commands Summary (continued)

Command	Query	Options and Query Returns
:MTESt:SOURce <source> (see page 377)	:MTESt:SOURce? (see page 377)	<source> ::= {CHANnel<n> NONE} <n> ::= {1 2 3 4} for 4ch models <n> ::= {1 2} for 2ch models
n/a	:MTESt:TITLe? (see page 378)	<title> ::= a string of up to 128 ASCII characters

Introduction to :MTESt Commands

Mask testing automatically compares the current displayed waveform with the boundaries of a set of polygons that you define. Any waveform or sample that falls within the boundaries of one or more polygons is recorded as a failure.

Reporting the Setup

Use :MTESt? to query setup information for the MTESt subsystem.

Return Format

The following is a sample response from the :MTESt? query. In this case, the query was issued following a *RST command.

```
:MTES:SOUR CHAN1;ENAB 0;LOCK 1;:MTES:AMAS:SOUR CHAN1;UNIT DIV;XDEL
+2.50000000E-001;YDEL +2.50000000E-001;:MTES:SCAL:BIND 0;X1
+200.000E-06;XDEL +400.000E-06;Y1 -3.00000E+00;Y2
+3.00000E+00;:MTES:RMOD FOR;RMOD:TIME +1E+00;WAV 1000;SIGM
+6.0E+00;:MTES:RMOD:FACT:STOP 0;PRIN 0;SAVE 0
```

Example Code

```
' Mask testing commands example.
' -----

Option Explicit

Public myMgr As VisaComLib.ResourceManager
Public myScope As VisaComLib.FormattedIO488
Public varQueryResult As Variant
Public strQueryResult As String

Private Declare Sub Sleep Lib "kernel32" (ByVal dwMilliseconds As Long)

Sub Main()

    On Error GoTo VisaComError

    ' Create the VISA COM I/O resource.
    Set myMgr = New VisaComLib.ResourceManager
    Set myScope = New VisaComLib.FormattedIO488
    Set myScope.IO = myMgr.Open("TCPIP0::130.29.70.228::inst0::INSTR")
    myScope.IO.Clear ' Clear the interface.
```

```

' Make sure oscilloscope is running.
myScope.WriteString ":RUN"

' Set mask test termination conditions.
myScope.WriteString ":MTESt:RMODE SIGMa"
myScope.WriteString ":MTESt:RMODE?"
strQueryResult = myScope.ReadString
Debug.Print "Mask test termination mode: " + strQueryResult

myScope.WriteString ":MTESt:RMODE:SIGMa 4.2"
myScope.WriteString ":MTESt:RMODE:SIGMa?"
varQueryResult = myScope.ReadNumber
Debug.Print "Mask test termination 'test sigma': " + _
    FormatNumber(varQueryResult)

' Use auto-mask to create mask.
myScope.WriteString ":MTESt:AMASk:SOURce CHANnel1"
myScope.WriteString ":MTESt:AMASk:SOURce?"
strQueryResult = myScope.ReadString
Debug.Print "Mask test auto-mask source: " + strQueryResult

myScope.WriteString ":MTESt:AMASk:UNITs DIVisions"
myScope.WriteString ":MTESt:AMASk:UNITs?"
strQueryResult = myScope.ReadString
Debug.Print "Mask test auto-mask units: " + strQueryResult

myScope.WriteString ":MTESt:AMASk:XDELta 0.1"
myScope.WriteString ":MTESt:AMASk:XDELta?"
varQueryResult = myScope.ReadNumber
Debug.Print "Mask test auto-mask X delta: " + _
    FormatNumber(varQueryResult)

myScope.WriteString ":MTESt:AMASk:YDELta 0.1"
myScope.WriteString ":MTESt:AMASk:YDELta?"
varQueryResult = myScope.ReadNumber
Debug.Print "Mask test auto-mask Y delta: " + _
    FormatNumber(varQueryResult)

' Enable "Auto Mask Created" event (bit 10, &H400)
myScope.WriteString "*CLS"
myScope.WriteString ":MTEenable " + CStr(CInt("&H400"))

' Create mask.
myScope.WriteString ":MTESt:AMASk:CREate"
Debug.Print "Auto-mask created, mask test automatically enabled."

' Set up timeout variables.
Dim lngTimeout As Long ' Max millisecs to wait.
Dim lngElapsed As Long
lngTimeout = 60000 ' 60 seconds.

' Wait until mask is created.
lngElapsed = 0
Do While lngElapsed <= lngTimeout
    myScope.WriteString ":OPERegister:CONDition?"
    varQueryResult = myScope.ReadNumber

```

5 Commands by Subsystem

```
' Operation Status Condition Register MTE bit (bit 9, &H200).
If (varQueryResult And &H200) <> 0 Then
    Exit Do
Else
    Sleep 100 ' Small wait to prevent excessive queries.
    lngElapsed = lngElapsed + 100
End If
Loop

' Look for RUN bit = stopped (mask test termination).
lngElapsed = 0
Do While lngElapsed <= lngTimeout
    myScope.WriteString ":OPERRegister:CONDition?"
    varQueryResult = myScope.ReadNumber
    ' Operation Status Condition Register RUN bit (bit 3, &H8).
    If (varQueryResult And &H8) = 0 Then
        Exit Do
    Else
        Sleep 100 ' Small wait to prevent excessive queries.
        lngElapsed = lngElapsed + 100
    End If
Loop

' Get total waveforms, failed waveforms, and test time.
myScope.WriteString ":MTEST:COUNT:WAVEforms?"
strQueryResult = myScope.ReadString
Debug.Print "Mask test total waveforms: " + strQueryResult

myScope.WriteString ":MTEST:COUNT:FWAVEforms?"
strQueryResult = myScope.ReadString
Debug.Print "Mask test failed waveforms: " + strQueryResult

myScope.WriteString ":MTEST:COUNT:TIME?"
strQueryResult = myScope.ReadString
Debug.Print "Mask test elapsed seconds: " + strQueryResult

Exit Sub

VisaComError:
    MsgBox "VISA COM Error:" + vbCrLf + Err.Description

End Sub
```

:MTESt:AMASk:CREate

N (see [page 740](#))

Command Syntax :MTESt:AMASk:CREate

The :MTESt:AMASk:CREate command automatically constructs a mask around the current selected channel, using the tolerance parameters defined by the :MTESt:AMASk:XDELta, :MTESt:AMASk:YDELta, and :MTESt:AMASk:UNITs commands. The mask only encompasses the portion of the waveform visible on the display, so you must ensure that the waveform is acquired and displayed consistently to obtain repeatable results.

The :MTESt:SOURce command selects the channel and should be set before using this command.

- See Also**
- "[Introduction to :MTESt Commands](#)" on page 348
 - "[:MTESt:AMASk:XDELta](#)" on page 354
 - "[:MTESt:AMASk:YDELta](#)" on page 355
 - "[:MTESt:AMASk:UNITs](#)" on page 353
 - "[:MTESt:AMASk:SOURce](#)" on page 352
 - "[:MTESt:SOURce](#)" on page 377

- Example Code**
- "[Example Code](#)" on page 348

:MTESt:AMASk:SOURce

N (see [page 740](#))

Command Syntax :MTESt:AMASk:SOURce <source>

<source> ::= CHANnel<n>

<n> ::= {1 | 2 | 3 | 4} for the four channel oscilloscope models

<n> ::= {1 | 2} for the two channel oscilloscope models

The :MTESt:AMASk:SOURce command selects the source for the interpretation of the :MTESt:AMASk:XDELta and :MTESt:AMASk:YDELta parameters when :MTESt:AMASk:UNITs is set to CURRent.

When UNITs are CURRent, the XDELta and YDELta parameters are defined in terms of the channel units, as set by the :CHANnel<n>:UNITs command, of the selected source.

Suppose that UNITs are CURRent and that you set SOURce to CHANNEL1, which is using units of volts. Then you can define AMASk:XDELta in terms of volts and AMASk:YDELta in terms of seconds.

This command is the same as the :MTESt:SOURce command.

Query Syntax :MTESt:AMASk:SOURce?

The :MTESt:AMASk:SOURce? query returns the currently set source.

Return Format <source> ::= CHAN<n>

<n> ::= {1 | 2 | 3 | 4} for the four channel oscilloscope models

<n> ::= {1 | 2} for the two channel oscilloscope models

- See Also**
- ["Introduction to :MTESt Commands"](#) on page 348
 - [":MTESt:AMASk:XDELta"](#) on page 354
 - [":MTESt:AMASk:YDELta"](#) on page 355
 - [":MTESt:AMASk:UNITs"](#) on page 353
 - [":MTESt:SOURce"](#) on page 377

Example Code • ["Example Code"](#) on page 348

:MTESt:AMASk:UNITs

N (see [page 740](#))

Command Syntax :MTESt:AMASk:UNITs <units>
 <units> ::= {CURRent | DIVisions}

The :MTESt:AMASk:UNITs command alters the way the mask test subsystem interprets the tolerance parameters for automasking as defined by :MTESt:AMASk:XDELta and :MTESt:AMASk:YDELta commands.

- CURRent – the mask test subsystem uses the units as set by the :CHANnel<n>:UNITs command, usually time for ΔX and voltage for ΔY .
- DIVisions – the mask test subsystem uses the graticule as the measurement system, so tolerance settings are specified as parts of a screen division. The mask test subsystem maintains separate XDELta and YDELta settings for CURRent and DIVisions. Thus, XDELta and YDELta are not converted to new values when the UNITs setting is changed.

Query Syntax :MTESt:AMASk:UNITs?

The :MTESt:AMASk:UNITs query returns the current measurement units setting for the mask test automask feature.

Return Format <units><NL>
 <units> ::= {CURR | DIV}

- See Also**
- ["Introduction to :MTESt Commands"](#) on page 348
 - [":MTESt:AMASk:XDELta"](#) on page 354
 - [":MTESt:AMASk:YDELta"](#) on page 355
 - [":CHANnel<n>:UNITs"](#) on page 226
 - [":MTESt:AMASk:SOURce"](#) on page 352
 - [":MTESt:SOURce"](#) on page 377

Example Code • ["Example Code"](#) on page 348

:MTESt:AMASk:XDELta

N (see [page 740](#))

Command Syntax :MTESt:AMASk:XDELta <value>
 <value> ::= X delta value in NR3 format

The :MTESt:AMASk:XDELta command sets the tolerance in the X direction around the waveform for the automasking feature. The absolute value of the tolerance will be added and subtracted to horizontal values of the waveform to determine the boundaries of the mask.

The horizontal tolerance value is interpreted based on the setting specified by the :MTESt:AMASk:UNITs command; thus, if you specify 250-E3, the setting for :MTESt:AMASk:UNITs is CURRent, and the current setting specifies time in the horizontal direction, the tolerance will be ± 250 ms. If the setting for :MTESt:AMASk:UNITs is DIVisions, the same X delta value will set the tolerance to ± 250 millidivisions, or 1/4 of a division.

Query Syntax :MTESt:AMASk:XDELta?

The :MTESt:AMASk:XDELta? query returns the current setting of the ΔX tolerance for automasking. If your computer program will interpret this value, it should also request the current measurement system using the :MTESt:AMASk:UNITs query.

Return Format <value><NL>
 <value> ::= X delta value in NR3 format

- See Also**
- "[Introduction to :MTESt Commands](#)" on page 348
 - "[:MTESt:AMASk:UNITs](#)" on page 353
 - "[:MTESt:AMASk:YDELta](#)" on page 355
 - "[:MTESt:AMASk:SOURce](#)" on page 352
 - "[:MTESt:SOURce](#)" on page 377

- Example Code**
- "[Example Code](#)" on page 348

:MTESt:AMASk:YDELta

N (see [page 740](#))

Command Syntax :MTESt:AMASk:YDELta <value>
 <value> ::= Y delta value in NR3 format

The :MTESt:AMASk:YDELta command sets the vertical tolerance around the waveform for the automasking feature. The absolute value of the tolerance will be added and subtracted to vertical values of the waveform to determine the boundaries of the mask.

The vertical tolerance value is interpreted based on the setting specified by the :MTESt:AMASk:UNITs command; thus, if you specify 250-E3, the setting for :MTESt:AMASk:UNITs is CURRent, and the current setting specifies voltage in the vertical direction, the tolerance will be ± 250 mV. If the setting for :MTESt:AMASk:UNITs is DIVisions, the same Y delta value will set the tolerance to ± 250 millidivisions, or 1/4 of a division.

Query Syntax :MTESt:AMASk:YDELta?

The :MTESt:AMASk:YDELta? query returns the current setting of the ΔY tolerance for automasking. If your computer program will interpret this value, it should also request the current measurement system using the :MTESt:AMASk:UNITs query.

Return Format <value><NL>
 <value> ::= Y delta value in NR3 format

- See Also**
- ["Introduction to :MTESt Commands"](#) on page 348
 - [":MTESt:AMASk:UNITs"](#) on page 353
 - [":MTESt:AMASk:XDELta"](#) on page 354
 - [":MTESt:AMASk:SOURce"](#) on page 352
 - [":MTESt:SOURce"](#) on page 377

- Example Code**
- ["Example Code"](#) on page 348

:MTESt:COUNT:FWAVEforms

N (see [page 740](#))

Query Syntax :MTESt:COUNT:FWAVEforms? [CHANnel<n>]

<n> ::= {1 | 2 | 3 | 4} for the four channel oscilloscope models

<n> ::= {1 | 2} for the two channel oscilloscope models

The :MTESt:COUNT:FWAVEforms? query returns the total number of failed waveforms in the current mask test run. This count is for all regions and all waveforms.

Return Format <failed><NL>

<failed> ::= number of failed waveforms in NR1 format.

- See Also**
- "[Introduction to :MTESt Commands](#)" on page 348
 - "[:MTESt:COUNT:WAVEforms](#)" on page 359
 - "[:MTESt:COUNT:TIME](#)" on page 358
 - "[:MTESt:COUNT:RESet](#)" on page 357
 - "[:MTESt:SOURce](#)" on page 377

Example Code • "[Example Code](#)" on page 348

:MTESt:COUNT:RESet

N (see [page 740](#))

Command Syntax :MTESt:COUNT:RESet

The :MTESt:COUNT:RESet command resets the mask statistics.

- See Also**
- ["Introduction to :MTESt Commands"](#) on page 348
 - [":MTESt:COUNT:WAVEforms"](#) on page 359
 - [":MTESt:COUNT:FWAVEforms"](#) on page 356
 - [":MTESt:COUNT:TIME"](#) on page 358

:MTEST:COUNT:TIME

N (see [page 740](#))

Query Syntax :MTEST:COUNT:TIME?

The :MTEST:COUNT:TIME? query returns the elapsed time in the current mask test run.

Return Format <time><NL>

<time> ::= elapsed seconds in NR3 format.

- See Also**
- ["Introduction to :MTEST Commands"](#) on page 348
 - [":MTEST:COUNT:WAVEforms"](#) on page 359
 - [":MTEST:COUNT:FWAVEforms"](#) on page 356
 - [":MTEST:COUNT:RESet"](#) on page 357

Example Code • ["Example Code"](#) on page 348

:MTESt:COUNT:WAVEforms

N (see [page 740](#))

Query Syntax :MTESt:COUNT:WAVEforms?

The :MTESt:COUNT:WAVEforms? query returns the total number of waveforms acquired in the current mask test run.

Return Format <count><NL>

<count> ::= number of waveforms in NR1 format.

- See Also**
- ["Introduction to :MTESt Commands"](#) on page 348
 - [":MTESt:COUNT:FWAVEforms"](#) on page 356
 - [":MTESt:COUNT:TIME"](#) on page 358
 - [":MTESt:COUNT:RESet"](#) on page 357

Example Code • ["Example Code"](#) on page 348

:MTEST:DATA

N (see [page 740](#))

Command Syntax :MTEST:DATA <mask>

<mask> ::= binary block data in IEEE 488.2 # format.

The :MTEST:DATA command loads a mask from binary block data.

Query Syntax :MTEST:DATA?

The :MTEST:DATA? query returns a mask in binary block data format. The format for the data transmission is the # format defined in the IEEE 488.2 specification.

Return Format <mask><NL>

<mask> ::= binary block data in IEEE 488.2 # format

- See Also**
- [":SAVE:MASK\[:START\]"](#) on [page 399](#)
 - [":RECall:MASK\[:START\]"](#) on [page 387](#)

:MTESt:DELeTe**N** (see [page 740](#))**Command Syntax** :MTESt:DELeTe

The :MTESt:DELeTe command clears the currently loaded mask.

- See Also**
- ["Introduction to :MTESt Commands"](#) on page 348
 - [":MTESt:AMASk:CREate"](#) on page 351

:MTEST:ENABLE

N (see [page 740](#))

Command Syntax :MTEST:ENABLE <on_off>
<on_off> ::= {{1 | ON} | {0 | OFF}}

The :MTEST:ENABLE command enables or disables the mask test features.

- ON – Enables the mask test features.
- OFF – Disables the mask test features.

Query Syntax :MTEST:ENABLE?

The :MTEST:ENABLE? query returns the current state of mask test features.

Return Format <on_off><NL>
<on_off> ::= {1 | 0}

See Also • ["Introduction to :MTEST Commands"](#) on page 348

:MTEST:LOCK

N (see [page 740](#))

Command Syntax :MTEST:LOCK <on_off>
 <on_off> ::= {{1 | ON} | {0 | OFF}}

The :MTEST:LOCK command enables or disables the mask lock feature:

- ON – Locks a mask to the SOURCE. As the vertical or horizontal scaling or position of the SOURCE changes, the mask is redrawn accordingly.
- OFF – The mask is static and does not move.

Query Syntax :MTEST:LOCK?

The :MTEST:LOCK? query returns the current mask lock setting.

Return Format <on_off><NL>
 <on_off> ::= {1 | 0}

- See Also**
- "[Introduction to :MTEST Commands](#)" on page 348
 - "[:MTEST:SOURCE](#)" on page 377

:MTESt:OUTPut

N (see [page 740](#))

Command Syntax :MTESt:OUTPut <signal>
<signal> ::= {FAIL | PASS}

The :MTESt:OUTPut command selects the mask test output condition:

- FAIL – the output occurs when there are mask test failures.
- PASS – the output occurs when the mask test passes.

You can place the mask test signal on the rear panel TRIG OUT BNC using the [":CALibrate:OUTPut"](#) on [page 203](#) command.

Query Syntax :MTESt:OUTPut?

The :MTESt:OUTPut? query returns the currently set output signal.

Return Format <signal><NL>
<signal> ::= {FAIL | PASS}

- See Also**
- ["Introduction to :MTESt Commands"](#) on [page 348](#)
 - [":CALibrate:OUTPut"](#) on [page 203](#)

:MTESt:RMODe

N (see [page 740](#))

Command Syntax :MTESt:RMODe <rmode>
 <rmode> ::= {FORever | SIGMa | TIME | WAVeforms}

The :MTESt:RMODe command specifies the termination conditions for the mask test:

- FORever – the mask test runs until it is turned off.
- SIGMa – the mask test runs until the Sigma level is reached. This level is set by the [":MTESt:RMODe:SIGMa"](#) on [page 369](#) command.
- TIME – the mask test runs for a fixed amount of time. The amount of time is set by the [":MTESt:RMODe:TIME"](#) on [page 370](#) command.
- WAVeforms – the mask test runs until a fixed number of waveforms are acquired. The number of waveforms is set by the [":MTESt:RMODe:WAVeforms"](#) on [page 371](#) command.

Query Syntax :MTESt:RMODe?

The :MTESt:RMODe? query returns the currently set termination condition.

Return Format <rmode><NL>
 <rmode> ::= {FOR | SIGM | TIME | WAV}

- See Also**
- ["Introduction to :MTESt Commands"](#) on [page 348](#)
 - [":MTESt:RMODe:SIGMa"](#) on [page 369](#)
 - [":MTESt:RMODe:TIME"](#) on [page 370](#)
 - [":MTESt:RMODe:WAVeforms"](#) on [page 371](#)

Example Code • ["Example Code"](#) on [page 348](#)

:MTESt:RMODe:FACTion:PRINt

N (see [page 740](#))

Command Syntax :MTESt:RMODe:FACTion:PRINt <on_off>
<on_off> ::= {{1 | ON} | {0 | OFF}}

The :MTESt:RMODe:FACTion:PRINt command sets printing on mask failures on or off.

NOTE

Setting :MTESt:RMODe:FACTion:PRINt ON automatically sets :MTESt:RMODe:FACTion:SAVE OFF.

See "[HARDcopy Commands](#)" on page 272 for more information on setting the hardcopy device and formatting options.

Query Syntax :MTESt:RMODe:FACTion:PRINt?

The :MTESt:RMODe:FACTion:PRINt? query returns the current mask failure print setting.

Return Format <on_off><NL>
<on_off> ::= {1 | 0}

- See Also**
- "[Introduction to :MTESt Commands](#)" on page 348
 - "[:MTESt:RMODe:FACTion:SAVE](#)" on page 367
 - "[:MTESt:RMODe:FACTion:STOP](#)" on page 368

:MTESt:RMODe:FACTion:SAVE

N (see [page 740](#))

Command Syntax :MTESt:RMODe:FACTion:SAVE <on_off>
 <on_off> ::= {{1 | ON} | {0 | OFF}}

The :MTESt:RMODe:FACTion:SAVE command sets saving on mask failures on or off.

NOTE

Setting :MTESt:RMODe:FACTion:SAVE ON automatically sets :MTESt:RMODe:FACTion:PRINt OFF.

See "[:SAVE Commands](#)" on page 390 for more information on save options.

Query Syntax :MTESt:RMODe:FACTion:SAVE?

The :MTESt:RMODe:FACTion:SAVE? query returns the current mask failure save setting.

Return Format <on_off><NL>
 <on_off> ::= {1 | 0}

- See Also**
- "[Introduction to :MTESt Commands](#)" on page 348
 - "[:MTESt:RMODe:FACTion:PRINt](#)" on page 366
 - "[:MTESt:RMODe:FACTion:STOP](#)" on page 368

:MTESt:RMODe:FACTion:STOP

N (see [page 740](#))

Command Syntax :MTESt:RMODe:FACTion:STOP <on_off>
<on_off> ::= {{1 | ON} | {0 | OFF}}

The :MTESt:RMODe:FACTion:STOP command sets stopping on a mask failure on or off. When this setting is ON and a mask violation is detected, the mask test is stopped and the acquisition system is stopped.

Query Syntax :MTESt:RMODe:FACTion:STOP?

The :MTESt:RMODe:FACTion:STOP? query returns the current mask failure stop setting.

Return Format <on_off><NL>
<on_off> ::= {1 | 0}

- See Also**
- "[Introduction to :MTESt Commands](#)" on page 348
 - "[:MTESt:RMODe:FACTion:PRINT](#)" on page 366
 - "[:MTESt:RMODe:FACTion:SAVE](#)" on page 367

:MTESt:RMODe:SIGMa

N (see [page 740](#))

Command Syntax :MTESt:RMODe:SIGMa <level>

<level> ::= from 0.1 to 9.3 in NR3 format

When the :MTESt:RMODe command is set to SIGMa, the :MTESt:RMODe:SIGMa command sets the *test sigma* level to which a mask test runs. *Test sigma* is the best achievable process sigma, assuming no failures. (*Process sigma* is calculated using the number of failures per test.) The *test sigma* level indirectly specifies the number of waveforms that must be tested (in order to reach the sigma level).

Query Syntax :MTESt:RMODe:SIGMa?

The :MTESt:RMODe:SIGMa? query returns the current Sigma level setting.

Return Format <level><NL>

<level> ::= from 0.1 to 9.3 in NR3 format

- See Also**
- ["Introduction to :MTESt Commands"](#) on page 348
 - [":MTESt:RMODe"](#) on page 365

- Example Code**
- ["Example Code"](#) on page 348

:MTESt:RMODe:TIME

N (see [page 740](#))

Command Syntax :MTESt:RMODe:TIME <seconds>

<seconds> ::= from 1 to 86400 in NR3 format

When the :MTESt:RMODe command is set to TIME, the :MTESt:RMODe:TIME command sets the number of seconds for a mask test to run.

Query Syntax :MTESt:RMODe:TIME?

The :MTESt:RMODe:TIME? query returns the number of seconds currently set.

Return Format <seconds><NL>

<seconds> ::= from 1 to 86400 in NR3 format

- See Also**
- "[Introduction to :MTESt Commands](#)" on page 348
 - "[:MTESt:RMODe](#)" on page 365

:MTESt:RMODe:WAVeforms

N (see [page 740](#))

Command Syntax :MTESt:RMODe:WAVeforms <count>

<count> ::= number of waveforms in NR1 format
from 1 to 2,000,000,000

When the :MTESt:RMODe command is set to WAVeforms, the :MTESt:RMODe:WAVeforms command sets the number of waveform acquisitions that are mask tested.

Query Syntax :MTESt:RMODe:WAVeforms?

The :MTESt:RMODe:WAVeforms? query returns the number of waveforms currently set.

Return Format <count><NL>

<count> ::= number of waveforms in NR1 format
from 1 to 2,000,000,000

- See Also**
- "[Introduction to :MTESt Commands](#)" on page 348
 - "[:MTESt:RMODe](#)" on page 365

:MTESt:SCALe:BIND

N (see [page 740](#))

Command Syntax :MTESt:SCALe:BIND <on_off>

<on_off> ::= {{1 | ON} | {0 | OFF}}

The :MTESt:SCALe:BIND command enables or disables Bind 1 & 0 Levels (Bind -1 & 0 Levels for inverted masks) control:

- ON –

If the Bind 1 & 0 Levels control is enabled, the 1 Level and the 0 Level controls track each other. Adjusting either the 1 Level or the 0 Level control shifts the position of the mask up or down without changing its size.

If the Bind -1 & 0 Levels control is enabled, the -1 Level and the 0 Level controls track each other. Adjusting either the -1 Level or the 0 Level control shifts the position of the mask up or down without changing its size.

- OFF –

If the Bind 1 & 0 Levels control is disabled, adjusting either the 1 Level or the 0 Level control changes the vertical height of the mask.

If the Bind -1 & 0 Levels control is disabled, adjusting either the -1 Level or the 0 Level control changes the vertical height of the mask.

Query Syntax :MTESt:SCALe:BIND?

The :MTESt:SCALe:BIND? query returns the value of the Bind 1&0 control (Bind -1&0 for inverted masks).

Return Format <on_off><NL>

<on_off> ::= {1 | 0}

- See Also**
- ["Introduction to :MTESt Commands"](#) on page 348
 - [":MTESt:SCALe:X1"](#) on page 373
 - [":MTESt:SCALe:XDELta"](#) on page 374
 - [":MTESt:SCALe:Y1"](#) on page 375
 - [":MTESt:SCALe:Y2"](#) on page 376

:MTESt:SCALe:X1

N (see [page 740](#))

Command Syntax :MTESt:SCALe:X1 <x1_value>
 <x1_value> ::= X1 value in NR3 format

The :MTESt:SCALe:X1 command defines where X=0 in the base coordinate system used for mask testing. The other X-coordinate is defined by the :MTESt:SCALe:XDELta command. Once the X1 and XDELta coordinates are set, all X values of vertices in the mask regions are defined with respect to this value, according to the equation:

$$X = (X * \Delta X) + X1$$

Thus, if you set X1 to 100 ms, and XDELta to 100 ms, an X value of 0.100 is a vertex at 110 ms.

The oscilloscope uses this equation to normalize vertices. This simplifies reprogramming to handle different data rates. For example, if you halve the period of the waveform of interest, you need only to adjust the XDELta value to set up the mask for the new waveform.

The X1 value is a time value specifying the location of the X1 coordinate, which will then be treated as X=0 for mask regions coordinates.

Query Syntax :MTESt:SCALe:X1?

The :MTESt:SCALe:X1? query returns the current X1 coordinate setting.

Return Format <x1_value><NL>
 <x1_value> ::= X1 value in NR3 format

- See Also**
- ["Introduction to :MTESt Commands"](#) on page 348
 - [":MTESt:SCALe:BIND"](#) on page 372
 - [":MTESt:SCALe:XDELta"](#) on page 374
 - [":MTESt:SCALe:Y1"](#) on page 375
 - [":MTESt:SCALe:Y2"](#) on page 376

:MTESt:SCALe:XDELta

N (see [page 740](#))

Command Syntax :MTESt:SCALe:XDELta <xdelta_value>
 <xdelta_value> ::= X delta value in NR3 format

The :MTESt:SCALe:XDELta command defines the position of the X2 marker with respect to the X1 marker. In the mask test coordinate system, the X1 marker defines where X=0; thus, the X2 marker defines where X=1.

Because all X vertices of the regions defined for mask testing are normalized with respect to X1 and ΔX , redefining ΔX also moves those vertices to stay in the same locations with respect to X1 and ΔX . Thus, in many applications, it is best if you define XDELta as a pulse width or bit period. Then, a change in data rate without corresponding changes in the waveform can easily be handled by changing ΔX .

The X-coordinate of polygon vertices is normalized using this equation:

$$X = (X * \Delta X) + X1$$

The X delta value is a time value specifying the distance of the X2 marker with respect to the X1 marker.

For example, if the period of the waveform you wish to test is 1 ms, setting ΔX to 1 ms ensures that the waveform's period is between the X1 and X2 markers.

Query Syntax :MTESt:SCALe:XDELta?

The :MTESt:SCALe:XDELta? query returns the current value of ΔX .

Return Format <xdelta_value><NL>
 <xdelta_value> ::= X delta value in NR3 format

- See Also**
- ["Introduction to :MTESt Commands"](#) on page 348
 - [":MTESt:SCALe:BIND"](#) on page 372
 - [":MTESt:SCALe:X1"](#) on page 373
 - [":MTESt:SCALe:Y1"](#) on page 375
 - [":MTESt:SCALe:Y2"](#) on page 376

:MTESt:SCALe:Y1

N (see [page 740](#))

Command Syntax :MTESt:SCALe:Y1 <y1_value>
 <y1_value> ::= Y1 value in NR3 format

The :MTESt:SCALe:Y1 command defines where Y=0 in the coordinate system for mask testing. All Y values of vertices in the coordinate system are defined with respect to the boundaries set by SCALe:Y1 and SCALe:Y2 according to the equation:

$$Y = (Y * (Y2 - Y1)) + Y1$$

Thus, if you set Y1 to 100 mV, and Y2 to 1 V, a Y value of 0.100 in a vertex is at 190 mV.

The Y1 value is a voltage value specifying the point at which Y=0.

Query Syntax :MTESt:SCALe:Y1?

The :MTESt:SCALe:Y1? query returns the current setting of the Y1 marker.

Return Format <y1_value><NL>
 <y1_value> ::= Y1 value in NR3 format

- See Also**
- ["Introduction to :MTESt Commands"](#) on page 348
 - [":MTESt:SCALe:BIND"](#) on page 372
 - [":MTESt:SCALe:X1"](#) on page 373
 - [":MTESt:SCALe:XDELta"](#) on page 374
 - [":MTESt:SCALe:Y2"](#) on page 376

:MTEST:SCALE:Y2

N (see [page 740](#))

Command Syntax :MTEST:SCALE:Y2 <y2_value>
 <y2_value> ::= Y2 value in NR3 format

The :MTEST:SCALE:Y2 command defines the Y2 marker in the coordinate system for mask testing. All Y values of vertices in the coordinate system are defined with respect to the boundaries defined by SCALE:Y1 and SCALE:Y2 according to the following equation:

$$Y = (Y * (Y2 - Y1)) + Y1$$

Thus, if you set Y1 to 100 mV, and Y2 to 1 V, a Y value of 0.100 in a vertex is at 190 mV.

The Y2 value is a voltage value specifying the location of the Y2 marker.

Query Syntax :MTEST:SCALE:Y2?

The :MTEST:SCALE:Y2? query returns the current setting of the Y2 marker.

Return Format <y2_value><NL>
 <y2_value> ::= Y2 value in NR3 format

- See Also**
- ["Introduction to :MTEST Commands"](#) on page 348
 - [":MTEST:SCALE:BIND"](#) on page 372
 - [":MTEST:SCALE:X1"](#) on page 373
 - [":MTEST:SCALE:XDELta"](#) on page 374
 - [":MTEST:SCALE:Y1"](#) on page 375

:MTESt:SOURce

N (see [page 740](#))

Command Syntax :MTESt:SOURce <source>

<source> ::= CHANnel<n>

<n> ::= {1 | 2 | 3 | 4} for the four channel oscilloscope models

<n> ::= {1 | 2} for the two channel oscilloscope models

The :MTESt:SOURce command selects the channel which is configured by the commands contained in a mask file when it is loaded.

Query Syntax :MTESt:SOURce?

The :MTESt:SOURce? query returns the channel which is configured by the commands contained in the current mask file.

Return Format <source><NL>

<source> ::= {CHAN<n> | NONE}

<n> ::= {1 | 2 | 3 | 4} for the four channel oscilloscope models

<n> ::= {1 | 2} for the two channel oscilloscope models

- See Also**
- ["Introduction to :MTESt Commands"](#) on page 348
 - [":MTESt:AMASk:SOURce"](#) on page 352

:MTESt:TITLe

N (see [page 740](#))

Query Syntax :MTESt:TITLe?

The :MTESt:TITLe? query returns the mask title which is a string of up to 128 characters. The title is displayed in the mask test dialog box and mask test tab when a mask file is loaded.

Return Format <title><NL>

<title> ::= a string of up to 128 ASCII characters.

See Also • ["Introduction to :MTESt Commands"](#) on page 348

:POD Commands

Control all oscilloscope functions associated with groups of digital channels. See "[Introduction to :POD<n> Commands](#)" on page 379.

Table 65 :POD<n> Commands Summary

Command	Query	Options and Query Returns
:POD<n>:DISPlay {{0 OFF} {1 ON}} (see page 380)	:POD<n>:DISPlay? (see page 380)	{0 1} <n> ::= 1-2 in NR1 format
:POD<n>:SIZE <value> (see page 381)	:POD<n>:SIZE? (see page 381)	<value> ::= {SMALl MEDium LARGe}
:POD<n>:THReshold <type>[suffix] (see page 382)	:POD<n>:THReshold? (see page 382)	<n> ::= 1-2 in NR1 format <type> ::= {CMOS ECL TTL <user defined value>} <user defined value> ::= value in NR3 format [suffix] ::= {V mV uV }

Introduction to :POD<n> Commands

<n> ::= {1 | 2}

The POD subsystem commands control the viewing and threshold of groups of digital channels.

POD1 ::= D0-D7

POD2 ::= D8-D15

NOTE

These commands are only valid for the MSO models.

Reporting the Setup

Use :POD1? or :POD2? to query setup information for the POD subsystem.

Return Format

The following is a sample response from the :POD1? query. In this case, the query was issued following a *RST command.

```
:POD1:DISP 0;THR +1.40E+00
```

:POD<n>:DISPlay

N (see [page 740](#))

Command Syntax :POD<n>:DISPlay <display>

<display> ::= {{1 | ON} | {0 | OFF}}

<n> ::= An integer, 1 or 2, is attached as a suffix to the command and defines the group of channels that are affected by the command.

POD1 ::= D0-D7

POD2 ::= D8-D15

The :POD<n>:DISPlay command turns displaying of the specified group of channels on or off.

NOTE

This command is only valid for the MSO models.

Query Syntax :POD<n>:DISPlay?

The :POD<n>:DISPlay? query returns the current display setting of the specified group of channels.

Return Format <display><NL>

<display> ::= {0 | 1}

- See Also**
- "[Introduction to :POD<n> Commands](#)" on page 379
 - "[:DIGital<n>:DISPlay](#)" on page 230
 - "[:CHANnel<n>:DISPlay](#)" on page 214
 - "[:VIEW](#)" on page 172
 - "[:BLANK](#)" on page 140
 - "[:STATus](#)" on page 169

:POD<n>:SIZE

N (see [page 740](#))

Command Syntax :POD<n>:SIZE <value>

<n> ::= An integer, 1 or 2, is attached as a suffix to the command and defines the group of channels that are affected by the command.

POD1 ::= D0-D7

POD2 ::= D8-D15

<value> ::= {SMALL | MEDIUM | LARGE}

The :POD<n>:SIZE command specifies the size of digital channels on the display.

NOTE

This command is only valid for the MSO models.

Query Syntax :POD<n>:SIZE?

The :POD<n>:SIZE? query returns the size setting for the specified group of channels.

Return Format <size_value><NL>

<size_value> ::= {SMALL | MEDIUM | LARGE}

- See Also**
- "[Introduction to :POD<n> Commands](#)" on page 379
 - "[:DIGital<n>:SIZE](#)" on page 233
 - "[:DIGital<n>:POSition](#)" on page 232

:POD<n>:THReshold

N (see [page 740](#))

Command Syntax :POD<n>:THReshold <type>[<suffix>]

<n> ::= An integer, 1 or 2, is attached as a suffix to the command and defines the group of channels that are affected by the command.

<type> ::= {CMOS | ECL | TTL | <user defined value>}

<user defined value> ::= -8.00 to +8.00 in NR3 format

<suffix> ::= {V | mV | uV}

POD1 ::= D0-D7

POD2 ::= D8-D15

TTL ::= 1.4V

CMOS ::= 2.5V

ECL ::= -1.3V

The :POD<n>:THReshold command sets the threshold for the specified group of channels. The threshold is used for triggering purposes and for displaying the digital data as high (above the threshold) or low (below the threshold).

NOTE

This command is only valid for the MSO models.

Query Syntax :POD<n>:THReshold?

The :POD<n>:THReshold? query returns the threshold value for the specified group of channels.

Return Format <threshold><NL>

<threshold> ::= Floating point number in NR3 format

- See Also**
- ["Introduction to :POD<n> Commands"](#) on page 379
 - [":DIGital<n>:THReshold"](#) on page 234
 - [":TRIGger\[:EDGE\]:LEVel"](#) on page 488

Example Code

```
' THRESHOLD - This command is used to set the voltage threshold for
' the waveforms. There are three preset values (TTL, CMOS, and ECL)
' and you can also set a user-defined threshold value between
' -8.0 volts and +8.0 volts.
'
' In this example, we set channels 0-7 to CMOS, then set channels
' 8-15 to a user-defined 2.0 volts, and then set the external trigger
' to TTL. Of course, you only need to set the thresholds for the
' channels you will be using in your program.
```

```
' Set channels 0-7 to CMOS threshold.  
myScope.WriteString ":POD1:THRESHOLD CMOS"  
  
' Set channels 8-15 to 2.0 volts.  
myScope.WriteString ":POD2:THRESHOLD 2.0"  
  
' Set external channel to TTL threshold (short form).  
myScope.WriteString ":TRIG:LEV TTL,EXT"
```

Example program from the start: ["VISA COM Example in Visual Basic"](#) on page 828

:RECall Commands

Recall previously saved oscilloscope setups and traces. See "Introduction to :RECall Commands" on page 384.

Table 66 :RECall Commands Summary

Command	Query	Options and Query Returns
:RECall:FILENAME <base_name> (see page 385)	:RECall:FILENAME? (see page 385)	<base_name> ::= quoted ASCII string
:RECall:IMAGE[:START] [<file_spec>] (see page 386)	n/a	<file_spec> ::= {<internal_loc> <file_name>} <internal_loc> ::= 0-9; an integer in NR1 format <file_name> ::= quoted ASCII string
:RECall:MASK[:START] [<file_spec>] (see page 387)	n/a	<file_spec> ::= {<internal_loc> <file_name>} <internal_loc> ::= 0-3; an integer in NR1 format <file_name> ::= quoted ASCII string
:RECall:PWD <path_name> (see page 388)	:RECall:PWD? (see page 388)	<path_name> ::= quoted ASCII string
:RECall:SETup[:START] [<file_spec>] (see page 389)	n/a	<file_spec> ::= {<internal_loc> <file_name>} <internal_loc> ::= 0-9; an integer in NR1 format <file_name> ::= quoted ASCII string

Introduction to :RECall Commands

The :RECall subsystem provides commands to recall previously saved oscilloscope setups and traces.

Reporting the Setup

Use :RECall? to query setup information for the RECall subsystem.

Return Format

The following is a sample response from the :RECall? query. In this case, the query was issued following the *RST command.

```
:REC:FIL "scope_0"
```

:RECall:FILEname

N (see [page 740](#))

Command Syntax :RECall:FILEname <base_name>

<base_name> ::= quoted ASCII string

The :RECall:FILEname command specifies the source for any RECall operations.

NOTE

This command specifies a file's base name only, without path information or an extension.

Query Syntax :RECall:FILEname?

The :RECall:FILEname? query returns the current RECall filename.

Return Format <base_name><NL>

<base_name> ::= quoted ASCII string

- See Also**
- "[Introduction to :RECall Commands](#)" on page 384
 - "[:RECall:IMAGe\[:START\]](#)" on page 386
 - "[:RECall:SETup\[:START\]](#)" on page 389
 - "[:SAVE:FILEname](#)" on page 392

:RECall:IMAGe[:START]

N (see [page 740](#))

Command Syntax :RECall:IMAGe[:START] [<file_spec>]
<file_spec> ::= {<internal_loc> | <file_name>}
<internal_loc> ::= 0-9; an integer in NR1 format
<file_name> ::= quoted ASCII string

The :RECall:IMAGe[:START] command recalls a trace (TIFF) image.

NOTE

If a file extension is provided as part of a specified <file_name>, it must be ".tif".

-
- See Also**
- ["Introduction to :RECall Commands"](#) on page 384
 - [":RECall:FILENAME"](#) on page 385
 - [":SAVE:IMAGe\[:START\]"](#) on page 393

:RECall:MASK[:START]

N (see [page 740](#))

Command Syntax :RECall:MASK[:START] [<file_spec>]
<file_spec> ::= {<internal_loc> | <file_name>}
<internal_loc> ::= 0-3; an integer in NR1 format
<file_name> ::= quoted ASCII string

The :RECall:MASK[:START] command recalls a mask.

NOTE

If a file extension is provided as part of a specified <file_name>, it must be ".msk".

- See Also**
- ["Introduction to :RECall Commands"](#) on page 384
 - [":RECall:FILENAME"](#) on page 385
 - [":SAVE:MASK\[:START\]"](#) on page 399
 - [":MTEST:DATA"](#) on page 360

:RECall:PWD

N (see [page 740](#))

Command Syntax :RECall:PWD <path_name>
<path_name> ::= quoted ASCII string

The :RECall:PWD command sets the present working directory for recall operations.

Query Syntax :RECall:PWD?

The :RECall:PWD? query returns the currently set working directory for recall operations.

Return Format <path_name><NL>
<path_name> ::= quoted ASCII string

- See Also**
- ["Introduction to :RECall Commands"](#) on page 384
 - [":SAVE:PWD"](#) on page 400

:RECall:SETup[:START]

N (see [page 740](#))

Command Syntax :RECall:SETup[:START] [<file_spec>]
 <file_spec> ::= {<internal_loc> | <file_name>}
 <internal_loc> ::= 0-9; an integer in NR1 format
 <file_name> ::= quoted ASCII string

The :RECall:SETup[:START] command recalls an oscilloscope setup.

NOTE

If a file extension is provided as part of a specified <file_name>, it must be ".scp".

- See Also**
- "[Introduction to :RECall Commands](#)" on page 384
 - "[:RECall:FILENAME](#)" on page 385
 - "[:SAVE:SETup\[:START\]](#)" on page 401

:SAVE Commands

Save oscilloscope setups and traces, screen images, and data. See "Introduction to :SAVE Commands" on page 391.

Table 67 :SAVE Commands Summary

Command	Query	Options and Query Returns
:SAVE:FILEname <base_name> (see page 392)	:SAVE:FILEname? (see page 392)	<base_name> ::= quoted ASCII string
:SAVE:IMAGe[:START] [<file_spec>] (see page 393)	n/a	<file_spec> ::= {<internal_loc> <file_name>} <internal_loc> ::= 0-9; an integer in NR1 format <file_name> ::= quoted ASCII string
n/a	:SAVE:IMAGe:AREA? (see page 394)	<area> ::= {GRAT SCR}
:SAVE:IMAGe:FACTors {0 OFF} {1 ON} (see page 395)	:SAVE:IMAGe:FACTors? (see page 395)	{0 1}
:SAVE:IMAGe:FORMat <format> (see page 396)	:SAVE:IMAGe:FORMat? (see page 396)	<format> ::= {TIFF {BMP BMP24bit} BMP8bit PNG NONE}
:SAVE:IMAGe:INKSaver {0 OFF} {1 ON} (see page 397)	:SAVE:IMAGe:INKSaver? (see page 397)	{0 1}
:SAVE:IMAGe:PALette <palette> (see page 398)	:SAVE:IMAGe:PALette? (see page 398)	<palette> ::= {COLor GRAYscale MONochrome}
:SAVE:MASK[:START] [<file_spec>] (see page 399)	n/a	<file_spec> ::= {<internal_loc> <file_name>} <internal_loc> ::= 0-3; an integer in NR1 format <file_name> ::= quoted ASCII string
:SAVE:PWD <path_name> (see page 400)	:SAVE:PWD? (see page 400)	<path_name> ::= quoted ASCII string

Table 67 :SAVE Commands Summary (continued)

Command	Query	Options and Query Returns
:SAVE:SETup[:START] [<file_spec>] (see page 401)	n/a	<file_spec> ::= {<internal_loc> <file_name>} <internal_loc> ::= 0-9; an integer in NR1 format <file_name> ::= quoted ASCII string
:SAVE:WAVEform[:START] [<file_name>] (see page 402)	n/a	<file_name> ::= quoted ASCII string
:SAVE:WAVEform:FORMat <format> (see page 403)	:SAVE:WAVEform:FORMat ? (see page 403)	<format> ::= {ALB ASCiixy CSV BINary NONE}
:SAVE:WAVEform:LENGth <length> (see page 404)	:SAVE:WAVEform:LENGth ? (see page 404)	<length> ::= 100 to max. length; an integer in NR1 format
:SAVE:WAVEform:SEGMent <option> (see page 405)	:SAVE:WAVEform:SEGMent? (see page 405)	<option> ::= {ALL CURRent}

Introduction to :SAVE Commands The :SAVE subsystem provides commands to save oscilloscope setups and traces, screen images, and data.

:SAV is an acceptable short form for :SAVE.

Reporting the Setup

Use :SAVE? to query setup information for the SAVE subsystem.

Return Format

The following is a sample response from the :SAVE? query. In this case, the query was issued following the *RST command.

```
:SAVE:FIL " "; :SAVE:IMAG:AREA GRAT;FACT 0;FORM TIFF;INKS 0;PAL
MON; :SAVE:PWD "C:/setups/"; :SAVE:WAV:FORM NONE;LENG 1000;SEGM CURR
```

:SAVE:FILENAME

N (see [page 740](#))

Command Syntax :SAVE:FILENAME <base_name>

<base_name> ::= quoted ASCII string

The :SAVE:FILENAME command specifies the source for any SAVE operations.

NOTE

This command specifies a file's base name only, without path information or an extension.

Query Syntax :SAVE:FILENAME?

The :SAVE:FILENAME? query returns the current SAVE filename.

Return Format <base_name><NL>

<base_name> ::= quoted ASCII string

- See Also**
- ["Introduction to :SAVE Commands"](#) on page 391
 - [":SAVE:IMAGe\[:START\]"](#) on page 393
 - [":SAVE:SETup\[:START\]"](#) on page 401
 - [":SAVE:WAVEform\[:START\]"](#) on page 402
 - [":SAVE:PWD"](#) on page 400
 - [":RECall:FILENAME"](#) on page 385

:SAVE:IMAGe[:START]

N (see [page 740](#))

Command Syntax :SAVE:IMAGe[:START] [<file_spec>]
 <file_spec> ::= {<internal_loc> | <file_name>}
 <internal_loc> ::= 0-9; an integer in NR1 format
 <file_name> ::= quoted ASCII string

The :SAVE:IMAGe[:START] command saves an image.

NOTE

If a file extension is provided as part of a specified <file_name>, and it does not match the extension expected by the format specified in :SAVE:IMAGe:FORMat, the format will be changed if the extension is a valid image file extension.

NOTE

If the extension ".bmp" is used and the current :SAVE:IMAGe:FORMat is not BMP or BMP8, the format will be changed to BMP.

NOTE

When the <internal_loc> option is used, the :SAVE:IMAGe:FORMat will be changed to TIFF.

- See Also**
- ["Introduction to :SAVE Commands"](#) on page 391
 - [":SAVE:IMAGe:AREA"](#) on page 394
 - [":SAVE:IMAGe:FACTors"](#) on page 395
 - [":SAVE:IMAGe:FORMat"](#) on page 396
 - [":SAVE:IMAGe:INKSaver"](#) on page 397
 - [":SAVE:IMAGe:PALette"](#) on page 398
 - [":SAVE:FILEname"](#) on page 392
 - [":RECall:IMAGe\[:START\]"](#) on page 386

:SAVE:IMAGe:AREA

N (see [page 740](#))

Query Syntax :SAVE:IMAGe:AREA?

The :SAVE:IMAGe:AREA? query returns the selected image area. If the :SAVE:IMAGe:FORMat is TIFF, the area is GRAT (graticule). Otherwise, it is SCR (screen).

Return Format <area><NL>

<area> ::= {GRAT | SCR}

- See Also**
- "[Introduction to :SAVE Commands](#)" on [page 391](#)
 - "[:SAVE:IMAGe\[:START\]](#)" on [page 393](#)
 - "[:SAVE:IMAGe:FACTors](#)" on [page 395](#)
 - "[:SAVE:IMAGe:FORMat](#)" on [page 396](#)
 - "[:SAVE:IMAGe:INKSaver](#)" on [page 397](#)
 - "[:SAVE:IMAGe:PALette](#)" on [page 398](#)

:SAVE:IMAGe:FACTors

N (see [page 740](#))

Command Syntax :SAVE:IMAGe:FACTors <factors>

<factors> ::= {{OFF | 0} | {ON | 1}}

The :SAVE:IMAGe:FACTors command controls whether the oscilloscope factors are output along with the image.

NOTE

Factors are written to a separate file with the same path and base name but with the ".txt" extension.

Query Syntax :SAVE:IMAGe:FACTors?

The :SAVE:IMAGe:FACTors? query returns a flag indicating whether oscilloscope factors are output along with the image.

Return Format <factors><NL>

<factors> ::= {0 | 1}

- See Also**
- ["Introduction to :SAVE Commands"](#) on page 391
 - [":SAVE:IMAGe\[:START\]"](#) on page 393
 - [":SAVE:IMAGe:AREA"](#) on page 394
 - [":SAVE:IMAGe:FORMat"](#) on page 396
 - [":SAVE:IMAGe:INKSaver"](#) on page 397
 - [":SAVE:IMAGe:PALette"](#) on page 398

:SAVE:IMAGe:FORMat

N (see [page 740](#))

Command Syntax :SAVE:IMAGe:FORMat <format>
<format> ::= {TIFF | {BMP | BMP24bit} | BMP8bit | PNG}

The :SAVE:IMAGe:FORMat command sets the image format type.

Query Syntax :SAVE:IMAGe:FORMat?

The :SAVE:IMAGe:FORMat? query returns the selected image format type.

Return Format <format><NL>
<format> ::= {TIFF | BMP | BMP8 | PNG | NONE}

When NONE is returned, it indicates that a waveform data file format is currently selected.

- See Also**
- ["Introduction to :SAVE Commands"](#) on page 391
 - [":SAVE:IMAGe\[:START\]"](#) on page 393
 - [":SAVE:IMAGe:AREA"](#) on page 394
 - [":SAVE:IMAGe:FACTors"](#) on page 395
 - [":SAVE:IMAGe:INKSaver"](#) on page 397
 - [":SAVE:IMAGe:PALette"](#) on page 398
 - [":SAVE:WAVEform:FORMat"](#) on page 403

:SAVE:IMAGe:INKSaver

N (see [page 740](#))

Command Syntax :SAVE:IMAGe:INKSaver <value>
 <value> ::= {{OFF | 0} | {ON | 1}}

The :SAVE:IMAGe:INKSaver command controls whether the graticule colors are inverted or not.

Query Syntax :SAVE:IMAGe:INKSaver?

The :SAVE:IMAGe:INKSaver? query returns a flag indicating whether graticule colors are inverted or not.

Return Format <value><NL>
 <value> ::= {0 | 1}

- See Also**
- ["Introduction to :SAVE Commands"](#) on page 391
 - [":SAVE:IMAGe\[:START\]"](#) on page 393
 - [":SAVE:IMAGe:AREA"](#) on page 394
 - [":SAVE:IMAGe:FACTors"](#) on page 395
 - [":SAVE:IMAGe:FORMat"](#) on page 396
 - [":SAVE:IMAGe:PALette"](#) on page 398

:SAVE:IMAGe:PALette

N (see [page 740](#))

Command Syntax :SAVE:IMAGe:PALette <palette>
<palette> ::= {COLor | GRAYscale | MONochrome}

The :SAVE:IMAGe:PALette command sets the image palette color.

NOTE

MONochrome is the only valid choice when the :SAVE:IMAGe:FORMat is TIFF. COLor and GRAYscale are the only valid choices when the format is not TIFF.

Query Syntax :SAVE:IMAGe:PALette?

The :SAVE:IMAGe:PALette? query returns the selected image palette color.

Return Format <palette><NL>
<palette> ::= {COL | GRAY | MON}

- See Also**
- "[Introduction to :SAVE Commands](#)" on page 391
 - "[:SAVE:IMAGe\[:START\]](#)" on page 393
 - "[:SAVE:IMAGe:AREA](#)" on page 394
 - "[:SAVE:IMAGe:FACTors](#)" on page 395
 - "[:SAVE:IMAGe:FORMat](#)" on page 396
 - "[:SAVE:IMAGe:INKSaver](#)" on page 397

:SAVE:MASK[:START]

N (see [page 740](#))

Command Syntax :SAVE:MASK[:START] [<file_spec>]
 <file_spec> ::= {<internal_loc> | <file_name>}
 <internal_loc> ::= 0-3; an integer in NR1 format
 <file_name> ::= quoted ASCII string

The :SAVE:MASK[:START] command saves a mask.

NOTE

If a file extension is provided as part of a specified <file_name>, it must be ".msk".

- See Also**
- ["Introduction to :SAVE Commands"](#) on page 391
 - [":SAVE:FILENAME"](#) on page 392
 - [":RECALL:MASK\[:START\]"](#) on page 387
 - [":MTEST:DATA"](#) on page 360

:SAVE:PWD

N (see [page 740](#))

Command Syntax :SAVE:PWD <path_name>
<path_name> ::= quoted ASCII string

The :SAVE:PWD command sets the present working directory for save operations.

Query Syntax :SAVE:PWD?

The :SAVE:PWD? query returns the currently set working directory for save operations.

Return Format <path_name><NL>
<path_name> ::= quoted ASCII string

- See Also**
- ["Introduction to :SAVE Commands"](#) on page 391
 - [":SAVE:FILENAME"](#) on page 392
 - [":RECALL:PWD"](#) on page 388

:SAVE:SETup[:START]

N (see [page 740](#))

Command Syntax :SAVE:SETup[:START] [<file_spec>
 <file_spec> ::= {<internal_loc> | <file_name>}
 <internal_loc> ::= 0-9; an integer in NR1 format
 <file_name> ::= quoted ASCII string

The :SAVE:SETup[:START] command saves an oscilloscope setup.

NOTE

If a file extension is provided as part of a specified <file_name>, it must be ".scp".

- See Also**
- "[Introduction to :SAVE Commands](#)" on page 391
 - "[:SAVE:FILENAME](#)" on page 392
 - "[:RECall:SETup\[:START\]](#)" on page 389

:SAVE:WAVEform[:START]

N (see [page 740](#))

Command Syntax :SAVE:WAVEform[:START] [<file_name>]
<file_name> ::= quoted ASCII string

The :SAVE:WAVEform[:START] command saves oscilloscope waveform data to a file.

NOTE

If a file extension is provided as part of a specified <file_name>, and it does not match the extension expected by the format specified in :SAVE:WAVEform:FORMat, the format will be changed if the extension is a valid waveform file extension.

- See Also**
- ["Introduction to :SAVE Commands"](#) on page 391
 - [":SAVE:WAVEform:FORMat"](#) on page 403
 - [":SAVE:WAVEform:LENGth"](#) on page 404
 - [":SAVE:FILEname"](#) on page 392
 - [":RECall:SETup\[:START\]"](#) on page 389

:SAVE:WAVEform:FORMat

N (see [page 740](#))

Command Syntax :SAVE:WAVEform:FORMat <format>

<format> ::= {ALB | ASCiixy | CSV | BINary}

The :SAVE:WAVEform:FORMat command sets the waveform data format type:

- ALB – creates an Agilent module binary format file. These files can be viewed offline by the *Agilent Logic Analyzer* application software. The proper file extension for this format is ".alb".
- ASCiixy – creates comma-separated value files for each analog channel that is displayed (turned on). The proper file extension for this format is ".csv".
- CSV – creates one comma-separated value file that contains information for all analog channels that are displayed (turned on). The proper file extension for this format is ".csv".
- BINary – creates an oscilloscope binary data format file. See the *User's Guide* for a description of this format. The proper file extension for this format is ".bin".

Query Syntax :SAVE:WAVEform:FORMat?

The :SAVE:WAVEform:FORMat? query returns the selected waveform data format type.

Return Format <format><NL>

<format> ::= {ALB | ASC | CSV | BIN | NONE}

When NONE is returned, it indicates that an image file format is currently selected.

- See Also**
- "[Introduction to :SAVE Commands](#)" on page 391
 - "[:SAVE:WAVEform\[:START\]](#)" on page 402
 - "[:SAVE:WAVEform:LENGth](#)" on page 404
 - "[:SAVE:IMAGe:FORMat](#)" on page 396

:SAVE:WAVEform:LENGth

N (see [page 740](#))

Command Syntax :SAVE:WAVEform:LENGth <length>

<length> ::= 100 to max. length; an integer in NR1 format

The :SAVE:WAVEform:LENGth command sets the waveform data length (that is, the number of points saved).

Query Syntax :SAVE:WAVEform:LENGth?

The :SAVE:WAVEform:LENGth? query returns the specified waveform data length.

Return Format <length><NL>

<length> ::= 100 to max. length; an integer in NR1 format

- See Also**
- ["Introduction to :SAVE Commands"](#) on page 391
 - [":SAVE:WAVEform\[:START\]"](#) on page 402
 - [":WAVEform:POINTs"](#) on page 586
 - [":SAVE:WAVEform:FORMat"](#) on page 403

:SAVE:WAVEform:SEGmented

N (see [page 740](#))

Command Syntax :SAVE:WAVEform:SEGmented <option>

<option> ::= {ALL | CURRent}

When segmented memory is used for acquisitions, the :SAVE:WAVEform:SEGmented command specifies which segments are included when the waveform is saved:

- ALL – all acquired segments are saved.
- CURRent – only the currently selected segment is saved.

Query Syntax :SAVE:WAVEform:SEGmented?

The :SAVE:WAVEform:SEGmented? query returns the current segmented waveform save option setting.

Return Format <option><NL>

<option> ::= {ALL | CURR}

- See Also**
- "Introduction to :SAVE Commands" on page 391
 - ":SAVE:WAVEform[:START]" on page 402
 - ":SAVE:WAVEform:FORMat" on page 403
 - ":SAVE:WAVEform:LENGth" on page 404

:SBUS Commands

Control oscilloscope functions associated with the serial decode bus. See "Introduction to :SBUS Commands" on page 407.

Table 68 :SBUS Commands Summary

Command	Query	Options and Query Returns
:SBUS:BUSDoctor:ADDRe ss <value> (see page 409)	:SBUS:BUSDoctor:ADDRe ss? (see page 409)	<value> ::= <field value>, <field value>, <field value>, <field value> <field value> ::= integer from 0-255 in NR1 format
:SBUS:BUSDoctor:BAUDr ate <baudrate> (see page 410)	:SBUS:BUSDoctor:BAUDr ate? (see page 410)	<baudrate> ::= {2500000 5000000 10000000}
:SBUS:BUSDoctor:CHANn el <channel> (see page 411)	:SBUS:BUSDoctor:CHANn el? (see page 411)	<channel> ::= {A B}
:SBUS:BUSDoctor:MODE <mode> (see page 412)	:SBUS:BUSDoctor:MODE? (see page 412)	<mode> ::= {ASYNchronous SYNchronous PC}
n/a	:SBUS:CAN:COUNT:ERRor ? (see page 413)	<frame_count> ::= integer in NR1 format
n/a	:SBUS:CAN:COUNT:OVERl oad? (see page 414)	<frame_count> ::= integer in NR1 format
:SBUS:CAN:COUNT:RESet (see page 415)	n/a	n/a
n/a	:SBUS:CAN:COUNT:TOTal ? (see page 416)	<frame_count> ::= integer in NR1 format
n/a	:SBUS:CAN:COUNT:UTILi zation? (see page 417)	<percent> ::= floating-point in NR3 format
:SBUS:DISPlay {{0 OFF} {1 ON}} (see page 418)	:SBUS:DISPlay? (see page 418)	{0 1}
n/a	:SBUS:FLEXray:COUNT:N ULL? (see page 419)	<frame_count> ::= integer in NR1 format
:SBUS:FLEXray:COUNT:R ESet (see page 420)	n/a	n/a
n/a	:SBUS:FLEXray:COUNT:S YNC? (see page 421)	<frame_count> ::= integer in NR1 format

Table 68 :SBUS Commands Summary (continued)

Command	Query	Options and Query Returns
n/a	:SBUS:FLEXray:COUNT:TOTal? (see page 422)	<frame_count> ::= integer in NR1 format
:SBUS:IIC:ASize <size> (see page 423)	:SBUS:IIC:ASIZE? (see page 423)	<size> ::= {BIT7 BIT8}
:SBUS:LIN:PARity {{0 OFF} {1 ON}} (see page 424)	:SBUS:LIN:PARity? (see page 424)	{0 1}
:SBUS:MODE <mode> (see page 425)	:SBUS:MODE? (see page 425)	<mode> ::= {IIC SPI CAN LIN FLEXray UART}
:SBUS:SPI:WIDTh <word_width> (see page 426)	:SBUS:SPI:WIDTH? (see page 426)	<word_width> ::= integer 4-16 in NR1 format
:SBUS:UART:BASE <base> (see page 427)	:SBUS:UART:BASE? (see page 427)	<base> ::= {ASCIi BINary HEX}
n/a	:SBUS:UART:COUNT:ERROr? (see page 428)	<frame_count> ::= integer in NR1 format
:SBUS:UART:COUNT:RESeT (see page 429)	n/a	n/a
n/a	:SBUS:UART:COUNT:RXFRames? (see page 430)	<frame_count> ::= integer in NR1 format
n/a	:SBUS:UART:COUNT:TXFRames? (see page 431)	<frame_count> ::= integer in NR1 format
:SBUS:UART:FRAMing <value> (see page 432)	:SBUS:UART:FRAMing? (see page 432)	<value> ::= {OFF <decimal> <nondecimal>} <decimal> ::= 8-bit integer from 0-255 (0x00-0xff) <nondecimal> ::= #Hnn where n ::= {0,...,9 A,...,F} for hexadecimal <nondecimal> ::= #Bnn...n where n ::= {0 1} for binary

Introduction to :SBUS Commands

The :SBUS subsystem commands control the serial decode bus viewing, mode, and other options.

NOTE

These commands are only valid on 4 (analog) channel oscilloscope models when a serial decode option has been licensed.

Reporting the Setup

5 Commands by Subsystem

Use `:SBUS?` to query setup information for the `:SBUS` subsystem.

Return Format

The following is a sample response from the `:SBUS?` query. In this case, the query was issued following a `*RST` command.

```
:SBUS:DISP 0;MODE IIC
```

:SBUS:BUSDoctor:ADDRESS

N (see [page 740](#))

Command Syntax :SBUS:BUSDoctor:ADDRESS <value>
 <value> ::= <field value>, <field value>, <field value>, <field value>
 <field value> ::= integer from 0-255 in NR1 format

The :SBUS:BUSDoctor:ADDRESS command sets the four byte values that make up the BusDoctor's IP address.

NOTE

This command is only valid on 4 (analog) channel oscilloscope models when the FlexRay triggering and serial decode option (Option FRS) has been licensed.

Query Syntax :SBUS:BUSDoctor:ADDRESS?

The :SBUS:BUSDoctor:ADDRESS? query returns the current BusDoctor IP address byte values.

Return Format <value><NL>
 <value> ::= <field value>, <field value>, <field value>, <field value>
 <field value> ::= integer from 0-255 in NR1 format

Errors • "-241, Hardware missing" on [page 699](#)

See Also • ["Introduction to :SBUS Commands"](#) on [page 407](#)
 • [":TRIGger:FLEXray Commands"](#) on [page 492](#)

:SBUS:BUSDoctor:BAUDrate

N (see [page 740](#))

Command Syntax :SBUS:BUSDoctor:BAUDrate <baudrate>
<baudrate> ::= {2500000 | 5000000 | 10000000}

The :SBUS:BUSDoctor:BAUDrate command sets the baud rate for the BusDoctor to 2.5 Mb/s, 5 Mb/s, or 10 Mb/s.

NOTE

This command is only valid on 4 (analog) channel oscilloscope models when the FlexRay triggering and serial decode option (Option FRS) has been licensed.

Query Syntax :SBUS:BUSDoctor:BAUDrate?

The :SBUS:BUSDoctor:BAUDrate? query returns the current BusDoctor baud rate setting.

Return Format <baudrate><NL>
<baudrate> ::= {2500000 | 5000000 | 10000000}

Errors • "-241, Hardware missing" on [page 699](#)

See Also • "Introduction to :SBUS Commands" on [page 407](#)

• ":TRIGger:FLEXray Commands" on [page 492](#)

:SBUS:BUSDoctor:CHANnel

N (see [page 740](#))

Command Syntax :SBUS:BUSDoctor:CHANnel <channel>

<channel> ::= {A | B}

The :SBUS:BUSDoctor:BAUDrate command sets the channel that the BusDoctor analyzes/preprocesses.

NOTE

This command is only valid on 4 (analog) channel oscilloscope models when the FlexRay triggering and serial decode option (Option FRS) has been licensed.

Query Syntax :SBUS:BUSDoctor:CHANnel?

The :SBUS:BUSDoctor:CHANnel? query returns the current BusDoctor channel setting.

Return Format <channel><NL>

<channel> ::= {A | B}

Errors • "-241, Hardware missing" on [page 699](#)

See Also • "Introduction to :SBUS Commands" on [page 407](#)

• ":TRIGger:FLEXray Commands" on [page 492](#)

:SBUS:BUSDoctor:MODE

N (see [page 740](#))

Command Syntax :SBUS:BUSDoctor:MODE <mode>
<mode> ::= {ASYNchronous | SYNchronous | PC}

The :SBUS:BUSDoctor:MODE command sets the operating mode of the BusDoctor:

- ASYNchronous – Oscilloscope controls BusDoctor, asynchronous mode monitoring (LAN connection required).
- SYNchronous – Oscilloscope controls BusDoctor, synchronous mode monitoring (LAN connection required).
- PC – PC running Decomsys VISION software controls BusDoctor.

NOTE

This command is only valid on 4 (analog) channel oscilloscope models when the FlexRay triggering and serial decode option (Option FRS) has been licensed.

Query Syntax :SBUS:BUSDoctor:MODE?

The :SBUS:BUSDoctor:MODE? query returns the current BusDoctor operating mode setting.

Return Format <mode><NL>
<mode> ::= {ASYN | SYNC | PC}

Errors • "-241, Hardware missing" on page 699

See Also • "Introduction to :SBUS Commands" on page 407
• ":TRIGger:FLEXray Commands" on page 492

:SBUS:CAN:COUNT:ERROR**N** (see [page 740](#))**Query Syntax** :SBUS:CAN:COUNT:ERROR?

Returns the error frame count.

Return Format <frame_count><NL>

<frame_count> ::= integer in NR1 format

Errors • ["-241, Hardware missing"](#) on page 699

- See Also**
-
- [":SBUS:CAN:COUNT:RESet"](#)
- on page 415
-
-
- ["Introduction to :SBUS Commands"](#)
- on page 407
-
-
- [":SBUS:MODE"](#)
- on page 425
-
-
- [":TRIGger:CAN Commands"](#)
- on page 465

:SBUS:CAN:COUNT:OVERload

N (see [page 740](#))

Query Syntax :SBUS:CAN:COUNT:OVERload?

Returns the overload frame count.

Return Format <frame_count><NL>

<frame_count> ::= integer in NR1 format

Errors • "-241, Hardware missing" on [page 699](#)

- See Also**
- [":SBUS:CAN:COUNT:RESet"](#) on [page 415](#)
 - ["Introduction to :SBUS Commands"](#) on [page 407](#)
 - [":SBUS:MODE"](#) on [page 425](#)
 - [":TRIGger:CAN Commands"](#) on [page 465](#)

:SBUS:CAN:COUNt:RESet**N** (see [page 740](#))**Command Syntax** :SBUS:CAN:COUNt:RESet

Resets the frame counters.

Errors • ["-241, Hardware missing"](#) on page 699

- See Also**
-
- [":SBUS:CAN:COUNt:ERRor"](#)
- on page 413
-
-
- [":SBUS:CAN:COUNt:OVERload"](#)
- on page 414
-
-
- [":SBUS:CAN:COUNt:TOTal"](#)
- on page 416
-
-
- [":SBUS:CAN:COUNt:UTILization"](#)
- on page 417
-
-
- ["Introduction to :SBUS Commands"](#)
- on page 407
-
-
- [":SBUS:MODE"](#)
- on page 425
-
-
- [":TRIGger:CAN Commands"](#)
- on page 465

:SBUS:CAN:COUNT:TOTAL

N (see [page 740](#))

Query Syntax :SBUS:CAN:COUNT:TOTAL?

Returns the total frame count.

Return Format <frame_count><NL>

<frame_count> ::= integer in NR1 format

Errors • "-241, Hardware missing" on [page 699](#)

- See Also**
- [":SBUS:CAN:COUNT:RESet"](#) on [page 415](#)
 - ["Introduction to :SBUS Commands"](#) on [page 407](#)
 - [":SBUS:MODE"](#) on [page 425](#)
 - [":TRIGger:CAN Commands"](#) on [page 465](#)

:SBUS:CAN:COUNT:UTILization**N** (see [page 740](#))**Query Syntax** :SBUS:CAN:COUNT:UTILization?

Returns the percent utilization.

Return Format <percent><NL>

<percent> ::= floating-point in NR3 format

Errors • ["-241, Hardware missing"](#) on page 699

- See Also**
-
- [":SBUS:CAN:COUNT:RESet"](#)
- on page 415
-
-
- ["Introduction to :SBUS Commands"](#)
- on page 407
-
-
- [":SBUS:MODE"](#)
- on page 425
-
-
- [":TRIGger:CAN Commands"](#)
- on page 465

:SBUS:DISPlay

N (see [page 740](#))

Command Syntax :SBUS:DISPlay <display>
<display> ::= {{1 | ON} | {0 | OFF}}

The :SBUS:DISPlay command turns displaying of the serial decode bus on or off.

NOTE

This command is only valid on 4 (analog) channel oscilloscope models when a serial decode option has been licensed.

Query Syntax :SBUS:DISPlay?

The :SBUS:DISPlay? query returns the current display setting of the serial decode bus.

Return Format <display><NL>
<display> ::= {0 | 1}

Errors • ["-241, Hardware missing"](#) on page 699

- See Also**
- ["Introduction to :SBUS Commands"](#) on page 407
 - [":CHANnel<n>:DISPlay"](#) on page 214
 - [":DIGital<n>:DISPlay"](#) on page 230
 - [":POD<n>:DISPlay"](#) on page 380
 - [":VIEW"](#) on page 172
 - [":BLANK"](#) on page 140
 - [":STATus"](#) on page 169

:SBUS:FLEXray:COUNT:NULL**N** (see [page 740](#))**Query Syntax** :SBUS:FLEXray:COUNT:NULL?

Returns the FlexRay null frame count.

Return Format <frame_count><NL>

<frame_count> ::= integer in NR1 format

Errors • ["-241, Hardware missing"](#) on page 699**See Also** • [":SBUS:FLEXray:COUNT:RESet"](#) on page 420
• ["Introduction to :SBUS Commands"](#) on page 407
• [":SBUS:MODE"](#) on page 425
• [":TRIGger:FLEXray Commands"](#) on page 492

:SBUS:FLEXray:COUNT:RESet

N (see [page 740](#))

Command Syntax :SBUS:FLEXray:COUNT:RESet

Resets the FlexRay frame counters.

Errors • "-241, Hardware missing" on [page 699](#)

- See Also**
- [":SBUS:FLEXray:COUNT:NULL"](#) on [page 419](#)
 - [":SBUS:FLEXray:COUNT:SYNC"](#) on [page 421](#)
 - [":SBUS:FLEXray:COUNT:TOTAL"](#) on [page 422](#)
 - ["Introduction to :SBUS Commands"](#) on [page 407](#)
 - [":SBUS:MODE"](#) on [page 425](#)
 - [":TRIGGER:FLEXray Commands"](#) on [page 492](#)

:SBUS:FLEXray:COUNT:SYNC**N** (see [page 740](#))**Query Syntax** :SBUS:FLEXray:COUNT:SYNC?

Returns the FlexRay sync frame count.

Return Format <frame_count><NL>

<frame_count> ::= integer in NR1 format

Errors • ["-241, Hardware missing"](#) on page 699

- See Also**
-
- [":SBUS:FLEXray:COUNT:RESet"](#)
- on page 420
-
-
- ["Introduction to :SBUS Commands"](#)
- on page 407
-
-
- [":SBUS:MODE"](#)
- on page 425
-
-
- [":TRIGger:FLEXray Commands"](#)
- on page 492

:SBUS:FLEXray:COUNT:TOTal

N (see [page 740](#))

Query Syntax :SBUS:FLEXray:COUNT:TOTal?

Returns the FlexRay total frame count.

Return Format <frame_count><NL>

<frame_count> ::= integer in NR1 format

Errors • ["-241, Hardware missing"](#) on page 699

- See Also**
- [":SBUS:FLEXray:COUNT:RESet"](#) on page 420
 - ["Introduction to :SBUS Commands"](#) on page 407
 - [":SBUS:MODE"](#) on page 425
 - [":TRIGger:FLEXray Commands"](#) on page 492

:SBUS:IIC:ASIZe

N (see [page 740](#))

Command Syntax :SBUS:IIC:ASIZe <size>
 <size> ::= {BIT7 | BIT8}

The :SBUS:IIC:ASIZe command determines whether the Read/Write bit is included as the LSB in the display of the IIC address field of the decode bus.

NOTE

This command is only valid on 4 (analog) channel oscilloscope models when the low-speed IIC and SPI serial decode option (Option LSS) has been licensed.

Query Syntax :SBUS:IIC:ASIZe?

The :SBUS:IIC:ASIZe? query returns the current IIC address width setting.

Return Format <mode><NL>
 <mode> ::= {BIT7 | BIT8}

Errors • "-241, Hardware missing" on [page 699](#)

See Also • "[Introduction to :SBUS Commands](#)" on [page 407](#)
 • "[:TRIGger:IIC Commands](#)" on [page 513](#)

:SBUS:LIN:PARity

N (see [page 740](#))

Command Syntax :SBUS:LIN:PARity <display>
<display> ::= {{1 | ON} | {0 | OFF}}

The :SBUS:LIN:PARity command determines whether the parity bits are included as the most significant bits (MSB) in the display of the Frame Id field in the LIN decode bus.

NOTE

This command is only valid on 4 (analog) channel oscilloscope models when the automotive CAN and LIN serial decode option (Option AMS) has been licensed.

Query Syntax :SBUS:LIN:PARity?

The :SBUS:LIN:PARity? query returns the current LIN parity bits display setting of the serial decode bus.

Return Format <display><NL>
<display> ::= {0 | 1}

Errors • ["-241, Hardware missing"](#) on page 699

See Also • ["Introduction to :SBUS Commands"](#) on page 407
• [":TRIGger:LIN Commands"](#) on page 522

:SBUS:MODE

N (see [page 740](#))

Command Syntax :SBUS:MODE <mode>

<mode> ::= {IIC | SPI | CAN | LIN | FLEXray | UART}

The :SBUS:MODE command determines the decode mode for the serial bus.

NOTE

This command is only valid on 4 (analog) channel oscilloscope models when a serial decode option has been licensed.

Query Syntax :SBUS:MODE?

The :SBUS:MODE? query returns the current serial bus decode mode setting.

Return Format <mode><NL>

<mode> ::= {IIC | SPI | CAN | LIN | FLEX | UART | NONE}

Errors • ["-241, Hardware missing"](#) on page 699

See Also • ["Introduction to :SBUS Commands"](#) on page 407

- [":TRIGger:MODE"](#) on page 460
- [":TRIGger:IIC Commands"](#) on page 513
- [":TRIGger:SPI Commands"](#) on page 538
- [":TRIGger:CAN Commands"](#) on page 465
- [":TRIGger:LIN Commands"](#) on page 522
- [":TRIGger:FLEXray Commands"](#) on page 492
- [":TRIGger:UART Commands"](#) on page 553

:SBUS:SPI:WIDTH

N (see [page 740](#))

Command Syntax :SBUS:SPI:WIDTH <word_width>
<word_width> ::= integer 4-16 in NR1 format

The :SBUS:SPI:WIDTH command determines the number of bits in a word of data for SPI.

NOTE

This command is only valid on 4 (analog) channel oscilloscope models when the low-speed IIC and SPI serial decode option (Option LSS) has been licensed.

Query Syntax :SBUS:SPI:WIDTH?

The :SBUS:SPI:WIDTH? query returns the current SPI decode word width.

Return Format <word_width><NL>
<word_width> ::= integer 4-16 in NR1 format

Errors • ["-241, Hardware missing"](#) on [page 699](#)

See Also • ["Introduction to :SBUS Commands"](#) on [page 407](#)
• [":SBUS:MODE"](#) on [page 425](#)
• [":TRIGger:SPI Commands"](#) on [page 538](#)

:SBUS:UART:BASE

N (see [page 740](#))

Command Syntax :SBUS:UART:BASE <base>
 <base> ::= {ASCii | BINary | HEX}

The :SBUS:UART:BASE command determines the base to use for the UART decode display.

NOTE

This command is only valid on 4 (analog) channel oscilloscope models when the UART/RS-232 triggering and serial decode option (Option 232) has been licensed.

Query Syntax :SBUS:UART:BASE?

The :SBUS:UART:BASE? query returns the current UART decode base setting.

Return Format <base><NL>
 <base> ::= {ASCii | BINary | HEX}

Errors • ["-241, Hardware missing"](#) on page 699

See Also • ["Introduction to :SBUS Commands"](#) on page 407
 • [":TRIGger:UART Commands"](#) on page 553

:SBUS:UART:COUNT:ERRor

N (see [page 740](#))

Query Syntax :SBUS:UART:COUNT:ERRor?

Returns the UART error frame count.

NOTE

This command is only valid on 4 (analog) channel oscilloscope models when the UART/RS-232 triggering and serial decode option (Option 232) has been licensed.

Return Format <frame_count><NL>

<frame_count> ::= integer in NR1 format

Errors • "-241, Hardware missing" on [page 699](#)

- See Also**
- [":SBUS:UART:COUNT:RESet"](#) on [page 429](#)
 - ["Introduction to :SBUS Commands"](#) on [page 407](#)
 - [":SBUS:MODE"](#) on [page 425](#)
 - [":TRIGger:UART Commands"](#) on [page 553](#)

:SBUS:UART:COUNt:RESet**N** (see [page 740](#))**Command Syntax** :SBUS:UART:COUNt:RESet

Resets the UART frame counters.

NOTE

This command is only valid on 4 (analog) channel oscilloscope models when the UART/RS-232 triggering and serial decode option (Option 232) has been licensed.

-
- Errors**
- ["-241, Hardware missing"](#) on page 699
- See Also**
- [":SBUS:UART:COUNt:ERRor"](#) on page 428
 - [":SBUS:UART:COUNt:RXFRames"](#) on page 430
 - [":SBUS:UART:COUNt:TXFRames"](#) on page 431
 - ["Introduction to :SBUS Commands"](#) on page 407
 - [":SBUS:MODE"](#) on page 425
 - [":TRIGger:UART Commands"](#) on page 553

:SBUS:UART:COUNt:RXFRames

N (see [page 740](#))

Query Syntax :SBUS:UART:COUNt:RXFRames?

Returns the UART Rx frame count.

NOTE

This command is only valid on 4 (analog) channel oscilloscope models when the UART/RS-232 triggering and serial decode option (Option 232) has been licensed.

Return Format <frame_count><NL>

<frame_count> ::= integer in NR1 format

Errors • "-241, Hardware missing" on [page 699](#)

- See Also**
- [":SBUS:UART:COUNt:RESet"](#) on [page 429](#)
 - ["Introduction to :SBUS Commands"](#) on [page 407](#)
 - [":SBUS:MODE"](#) on [page 425](#)
 - [":TRIGger:UART Commands"](#) on [page 553](#)

:SBUS:UART:COUNt:TXFRames**N** (see [page 740](#))**Query Syntax** :SBUS:UART:COUNt:TXFRames?

Returns the UART Tx frame count.

NOTE

This command is only valid on 4 (analog) channel oscilloscope models when the UART/RS-232 triggering and serial decode option (Option 232) has been licensed.

Return Format <frame_count><NL>

<frame_count> ::= integer in NR1 format

Errors • "-241, Hardware missing" on [page 699](#)

- See Also**
-
- [":SBUS:UART:COUNt:RESet"](#)
- on
- [page 429](#)
-
-
- ["Introduction to :SBUS Commands"](#)
- on
- [page 407](#)
-
-
- [":SBUS:MODE"](#)
- on
- [page 425](#)
-
-
- [":TRIGger:UART Commands"](#)
- on
- [page 553](#)

:SBUS:UART:FRAMing

N (see [page 740](#))

Command Syntax :SBUS:UART:FRAMing <value>
 <value> ::= {OFF | <decimal> | <nondecimal>}
 <decimal> ::= 8-bit integer in decimal from 0-255 (0x00-0xff)
 <nondecimal> ::= #Hnn where n ::= {0,...,9 | A,...,F} for hexadecimal
 <nondecimal> ::= #Bnn...n where n ::= {0 | 1} for binary

The :SBUS:UART:FRAMing command determines the byte value to use for framing (end of packet) or to turn off framing for UART decode.

NOTE

This command is only valid on 4 (analog) channel oscilloscope models when the UART/RS-232 triggering and serial decode option (Option 232) has been licensed.

Query Syntax :SBUS:UART:FRAMing?

The :SBUS:UART:FRAMing? query returns the current UART decode base setting.

Return Format <value><NL>
 <value> ::= {OFF | <decimal>}
 <decimal> ::= 8-bit integer in decimal from 0-255

Errors • "-241, Hardware missing" on [page 699](#)

See Also • ["Introduction to :SBUS Commands"](#) on [page 407](#)
 • [":TRIGger:UART Commands"](#) on [page 553](#)

:SYSTEM Commands

Control basic system functions of the oscilloscope. See "Introduction to :SYSTEM Commands" on page 433.

Table 69 :SYSTEM Commands Summary

Command	Query	Options and Query Returns
:SYSTEM:DATE <date> (see page 434)	:SYSTEM:DATE? (see page 434)	<date> ::= <year>,<month>,<day> <year> ::= 4-digit year in NR1 format <month> ::= {1,...,12 JANuary FEBruary MARch APRil MAY JUNE JULy AUGust SEPTember OCTober NOVember DECember} <day> ::= {1,..31}
:SYSTEM:DSP <string> (see page 435)	n/a	<string> ::= up to 254 characters as a quoted ASCII string
n/a	:SYSTEM:ERROR? (see page 436)	<error> ::= an integer error code <error string> ::= quoted ASCII string. See Error Messages (see page 697).
:SYSTEM:LOCK <value> (see page 437)	:SYSTEM:LOCK? (see page 437)	<value> ::= {{1 ON} {0 OFF}}
:SYSTEM:PROTECTION:LOCK <value> (see page 438)	:SYSTEM:PROTECTION:LOCK? (see page 438)	<value> ::= {{1 ON} {0 OFF}}
:SYSTEM:SETup <setup_data> (see page 439)	:SYSTEM:SETup? (see page 439)	<setup_data> ::= data in IEEE 488.2 # format.
:SYSTEM:TIME <time> (see page 441)	:SYSTEM:TIME? (see page 441)	<time> ::= hours,minutes,seconds in NR1 format

Introduction to :SYSTEM Commands SYSTEM subsystem commands enable writing messages to the display, setting and reading both the time and the date, querying for errors, and saving and recalling setups.

:SYSTem:DATE

N (see [page 740](#))

Command Syntax :SYSTem:DATE <date>

<date> ::= <year>,<month>,<day>

<year> ::= 4-digit year in NR1 format

<month> ::= {1,...,12 | JANuary | FEBruary | MARCH | APRil | MAY | JUNE
| JULy | AUGust | SEPTember | OCTober | NOVember | DECember}

<day> ::= {1,...,31}

The :SYSTem:DATE command sets the date. Validity checking is performed to ensure that the date is valid.

Query Syntax :SYSTem:DATE?

The SYSTem:DATE? query returns the date.

Return Format <year>,<month>,<day><NL>

- See Also**
- "[Introduction to :SYSTem Commands](#)" on page 433
 - "[:SYSTem:TIME](#)" on page 441

:SYSTem:DSP

N (see [page 740](#))

Command Syntax :SYSTem:DSP <string>
<string> ::= quoted ASCII string (up to 254 characters)

The :SYSTem:DSP command writes the quoted string (excluding quotation marks) to a text box in the center of the display. Use :SYSTem:DSP "" to remotely remove the message from the display. (Two sets of quote marks without a space between them creates a NULL string.) Press any menu key to manually remove the message from the display.

See Also • ["Introduction to :SYSTem Commands"](#) on page 433

:SYSTem:ERRor

C (see [page 740](#))

Query Syntax :SYSTem:ERRor?

The :SYSTem:ERRor? query outputs the next error number and text from the error queue. The instrument has an error queue that is 30 errors deep and operates on a first-in, first-out basis. Repeatedly sending the :SYSTem:ERRor? query returns the errors in the order that they occurred until the queue is empty. Any further queries then return zero until another error occurs.

Return Format <error number>,<error string><NL>

<error number> ::= an integer error code in NR1 format

<error string> ::= quoted ASCII string containing the error message

Error messages are listed in "[Error Messages](#)" on page 697.

- See Also**
- "[Introduction to :SYSTem Commands](#)" on page 433
 - "[*ESR \(Standard Event Status Register\)](#)" on page 112
 - "[*CLS \(Clear Status\)](#)" on page 109

:SYSTem:LOCK

N (see [page 740](#))

Command Syntax :SYSTem:LOCK <value>
<value> ::= {{1 | ON} | {0 | OFF}}

The :SYSTem:LOCK command disables the front panel. LOCK ON is the equivalent of sending a local lockout message over the programming interface.

Query Syntax :SYSTem:LOCK?

The :SYSTem:LOCK? query returns the lock status of the front panel.

Return Format <value><NL>
<value> ::= {1 | 0}

See Also • ["Introduction to :SYSTem Commands"](#) on page 433

:SYSTem:PROTection:LOCK

N (see [page 740](#))

Command Syntax :SYSTem:PROTection:LOCK <value>
<value> ::= {{1 | ON} | {0 | OFF}}

The :SYSTem:PROTection:LOCK command disables the fifty ohm impedance setting for all analog channels.

Query Syntax :SYSTem:PROTection:LOCK?

The :SYSTem:PROTection:LOCK? query returns the analog channel protection lock status.

Return Format <value><NL>
<value> ::= {1 | 0}

See Also • ["Introduction to :SYSTem Commands"](#) on page 433

:SYSTEM:SETup

C (see [page 740](#))

Command Syntax :SYSTEM:SETup <setup_data>

<setup_data> ::= binary block data in IEEE 488.2 # format.

The :SYSTEM:SETup command sets the oscilloscope as defined by the data in the setup (learn) string sent from the controller. The setup string does not change the interface mode or interface address.

Query Syntax :SYSTEM:SETup?

The :SYSTEM:SETup? query operates the same as the *LRN? query. It outputs the current oscilloscope setup in the form of a learn string to the controller. The setup (learn) string is sent and received as a binary block of data. The format for the data transmission is the # format defined in the IEEE 488.2 specification.

Return Format <setup_data><NL>

<setup_data> ::= binary block data in IEEE 488.2 # format

- See Also**
- ["Introduction to :SYSTEM Commands"](#) on page 433
 - ["*LRN \(Learn Device Setup\)"](#) on page 115

Example Code

```
' SAVE_SYSTEM_SETUP - The :SYSTEM:SETUP? query returns a program
' message that contains the current state of the instrument. Its
' format is a definite-length binary block, for example,
' #800002204<setup string><NL>
' where the setup string is 2204 bytes in length.
myScope.WriteString ":SYSTEM:SETUP?"
varQueryResult = myScope.ReadIEEEBlock(BinaryType_UI1)
CheckForInstrumentErrors ' After reading query results.

' Output setup string to a file:
Dim strPath As String
strPath = "c:\scope\config\setup.dat"

' Open file for output.
Close #1 ' If #1 is open, close it.
Open strPath For Binary Access Write Lock Write As #1
Put #1, , varQueryResult ' Write data.
Close #1 ' Close file.

' RESTORE_SYSTEM_SETUP - Read the setup string from a file and
' write it back to the oscilloscope.
Dim varSetupString As Variant
strPath = "c:\scope\config\setup.dat"

' Open file for input.
Open strPath For Binary Access Read As #1
Get #1, , varSetupString ' Read data.
Close #1 ' Close file.
```

5 Commands by Subsystem

```
' Write setup string back to oscilloscope using ":SYSTEM:SETUP"  
' command:  
myScope.WriteIEEEBlock ":SYSTEM:SETUP ", varSetupString  
CheckForInstrumentErrors
```

Example program from the start: ["VISA COM Example in Visual Basic"](#) on page 828

:SYSTem:TIME

N (see [page 740](#))

Command Syntax :SYSTem:TIME <time>

<time> ::= hours,minutes,seconds in NR1 format

The :SYSTem:TIME command sets the system time, using a 24-hour format. Commas are used as separators. Validity checking is performed to ensure that the time is valid.

Query Syntax :SYSTem:TIME? <time>

The :SYSTem:TIME? query returns the current system time.

Return Format <time><NL>

<time> ::= hours,minutes,seconds in NR1 format

- See Also**
- "[Introduction to :SYSTEM Commands](#)" on page 433
 - "[:SYSTEM:DATE](#)" on page 434

:TIMebase Commands

Control all horizontal sweep functions. See "Introduction to :TIMebase Commands" on page 443.

Table 70 :TIMebase Commands Summary

Command	Query	Options and Query Returns
:TIMebase:MODE <value> (see page 444)	:TIMebase:MODE? (see page 444)	<value> ::= {MAIN WINDow XY ROLL}
:TIMebase:POSition <pos> (see page 445)	:TIMebase:POSition? (see page 445)	<pos> ::= time from the trigger event to the display reference point in NR3 format
:TIMebase:RANGe <range_value> (see page 446)	:TIMebase:RANGe? (see page 446)	<range_value> ::= 5 ns through 500 s in NR3 format
:TIMebase:REFClock {0 OFF} {1 ON} (see page 447)	:TIMebase:REFClock? (see page 447)	{0 1}
:TIMebase:REFerence {LEFT CENTer RIGHT} (see page 448)	:TIMebase:REFerence? (see page 448)	<return_value> ::= {LEFT CENTer RIGHT}
:TIMebase:SCALe <scale_value> (see page 449)	:TIMebase:SCALe? (see page 449)	<scale_value> ::= scale value in seconds in NR3 format
:TIMebase:VERNier {0 OFF} {1 ON} (see page 450)	:TIMebase:VERNier? (see page 450)	{0 1}
:TIMebase:WINDow:POSition <pos> (see page 451)	:TIMebase:WINDow:POSition? (see page 451)	<pos> ::= time from the trigger event to the zoomed view reference point in NR3 format
:TIMebase:WINDow:RANGe <range_value> (see page 452)	:TIMebase:WINDow:RANGe? (see page 452)	<range value> ::= range value in seconds in NR3 format for the zoomed window
:TIMebase:WINDow:SCALe <scale_value> (see page 453)	:TIMebase:WINDow:SCALe? (see page 453)	<scale_value> ::= scale value in seconds in NR3 format for the zoomed window

Introduction to :TIMEbase Commands The TIMEbase subsystem commands control the horizontal (X-axis) functions and set the oscilloscope to X-Y mode (where channel 1 becomes the X input and channel 2 becomes the Y input). The time per division, delay, vernier control, and reference can be controlled for the main and window (zoomed) time bases.

Reporting the Setup

Use :TIMEbase? to query setup information for the TIMEbase subsystem.

Return Format

The following is a sample response from the :TIMEbase? query. In this case, the query was issued following a *RST command.

```
:TIM:MODE MAIN;REF CENT;MAIN:RANG +1.00E-03;POS +0.0E+00
```

:TIMEbase:MODE

C (see [page 740](#))

Command Syntax :TIMEbase:MODE <value>
 <value> ::= {MAIN | WINDow | XY | ROLL}

The :TIMEbase:MODE command sets the current time base. There are four time base modes:

- **MAIN** – The normal time base mode is the main time base. It is the default time base mode after the *RST (Reset) command.
- **WINDow** – In the WINDow (zoomed or delayed) time base mode, measurements are made in the zoomed time base if possible; otherwise, the measurements are made in the main time base.
- **XY** – In the XY mode, the :TIMEbase:RANGe, :TIMEbase:POSition, and :TIMEbase:REFerence commands are not available. No measurements are available in this mode.
- **ROLL** – In the ROLL mode, data moves continuously across the display from left to right. The oscilloscope runs continuously and is untriggered. The :TIMEbase:REFerence selection changes to RIGHT.

NOTE

If a :DIGitize command is executed when the :TIMEbase:MODE is not MAIN, the :TIMEbase:MODE is set to MAIN.

Query Syntax :TIMEbase:MODE?

The :TIMEbase:MODE query returns the current time base mode.

Return Format <value><NL>
 <value> ::= {MAIN | WIND | XY | ROLL}

- See Also**
- ["Introduction to :TIMEbase Commands"](#) on page 443
 - ["*RST \(Reset\)"](#) on page 120
 - [":TIMEbase:RANGe"](#) on page 446
 - [":TIMEbase:POSition"](#) on page 445
 - [":TIMEbase:REFerence"](#) on page 448

Example Code

```
' TIMEBASE_MODE - (not executed in this example)
' Set the time base mode to MAIN, DELAYED, XY, or ROLL.

' Set time base mode to main.
myScope.WriteString ":TIMEBASE:MODE MAIN"
```

Example program from the start: ["VISA COM Example in Visual Basic"](#) on page 828

:TIMEbase:POSition

C (see [page 740](#))

Command Syntax :TIMEbase:POSition <pos>

<pos> ::= time in seconds from the trigger to the display reference
in NR3 format

The :TIMEbase:POSition command sets the time interval between the trigger event and the display reference point on the screen. The display reference point is either left, right, or center and is set with the :TIMEbase:REFerence command. The maximum position value depends on the time/division settings.

NOTE

This command is an alias for the :TIMEbase:DELay command.

Query Syntax :TIMEbase:POSition?

The :TIMEbase:POSition? query returns the current time from the trigger to the display reference in seconds.

Return Format <pos><NL>

<pos> ::= time in seconds from the trigger to the display reference
in NR3 format

- See Also**
- ["Introduction to :TIMEbase Commands"](#) on page 443
 - [":TIMEbase:REFerence"](#) on page 448
 - [":TIMEbase:RANGe"](#) on page 446
 - [":TIMEbase:SCALE"](#) on page 449
 - [":TIMEbase:WINDow:POSition"](#) on page 451
 - [":TIMEbase:DELay"](#) on page 690

:TIMEbase:RANGe

C (see [page 740](#))

Command Syntax :TIMEbase:RANGe <range_value>

<range_value> ::= 5 ns through 500 s in NR3 format

The :TIMEbase:RANGe command sets the full-scale horizontal time in seconds for the main window. The range is 10 times the current time-per-division setting.

Query Syntax :TIMEbase:RANGe?

The :TIMEbase:RANGe query returns the current full-scale range value for the main window.

Return Format <range_value><NL>

<range_value> ::= 5 ns through 500 s in NR3 format

- See Also**
- ["Introduction to :TIMEbase Commands"](#) on page 443
 - [":TIMEbase:MODE"](#) on page 444
 - [":TIMEbase:SCALE"](#) on page 449
 - [":TIMEbase:WINDow:RANGe"](#) on page 452

Example Code

```
' TIME_RANGE - Sets the full scale horizontal time in seconds. The  
' range value is 10 times the time per division.  
myScope.WriteString ":TIM:RANG 2e-3" ' Set the time range to 0.002  
seconds.
```

Example program from the start: ["VISA COM Example in Visual Basic"](#) on page 828

:TIMEbase:REFClock

N (see [page 740](#))

Command Syntax :TIMEbase:REFClock <value>
 <value> ::= {{1 | ON} | {0 | OFF}}

The :TIMEbase:REFClock command enables or disables the 10 MHz REF BNC located on the rear panel of the oscilloscope.

The 10 MHz REF BNC can be used as an input for the oscilloscope's reference clock (instead of the internal 10 MHz reference), or it can be used to output the internal 10 MHz reference clock when synchronizing multiple instruments (see [":ACQUIRE:RSIGNAL"](#) on page 181).

The :TIMEbase:REFClock ON command enables the 10 MHz REF BNC and sets the reference signal mode to IN. The :TIMEbase:REFClock OFF command disables the 10 MHz REF BNC (the same as setting the reference signal mode to OFF).

Query Syntax :TIMEbase:REFClock?

The :TIMEbase:REFClock? query returns the current state of the 10 MHz reference signal mode. A "1" indicates that the 10 MHz REF input is enabled (on), and a "0" indicates that either the 10 MHz REF BNC is disabled (off) or that it is set as an output (by the [:ACQUIRE:RSIGNAL](#) command).

Return Format <value><NL>
 <value> ::= {0 | 1}

See Also • [":ACQUIRE:RSIGNAL"](#) on page 181

:TIMEbase:REFErence

C (see [page 740](#))

Command Syntax :TIMEbase:REFErence <reference>
<reference> ::= {LEFT | CENTer | RIGHT}

The :TIMEbase:REFErence command sets the time reference to one division from the left side of the screen, to the center of the screen, or to one division from the right side of the screen. Time reference is the point on the display where the trigger point is referenced.

Query Syntax :TIMEbase:REFErence?

The :TIMEbase:REFErence? query returns the current display reference for the main window.

Return Format <reference><NL>
<reference> ::= {LEFT | CENT | RIGH}

- See Also**
- ["Introduction to :TIMEbase Commands"](#) on page 443
 - [":TIMEbase:MODE"](#) on page 444

Example Code

```
' TIME_REFERENCE - Possible values are LEFT and CENTER.  
' - LEFT sets the display reference on time division from the left.  
' - CENTER sets the display reference to the center of the screen.  
myScope.WriteString ":TIMEBASE:REFERENCE CENTER" ' Set reference to  
center.
```

Example program from the start: ["VISA COM Example in Visual Basic"](#) on page 828

:TIMEbase:SCALE

N (see [page 740](#))

Command Syntax :TIMEbase:SCALE <scale_value>

<scale_value> ::= 500 ps through 50 s in NR3 format

The :TIMEbase:SCALE command sets the horizontal scale or units per division for the main window.

Query Syntax :TIMEbase:SCALE?

The :TIMEbase:SCALE? query returns the current horizontal scale setting in seconds per division for the main window.

Return Format <scale_value><NL>

<scale_value> ::= 500 ps through 50 s in NR3 format

- See Also**
- ["Introduction to :TIMEbase Commands"](#) on page 443
 - [":TIMEbase:RANGE"](#) on page 446
 - [":TIMEbase:WINDOW:SCALE"](#) on page 453
 - [":TIMEbase:WINDOW:RANGE"](#) on page 452

:TIMEbase:VERNier

N (see [page 740](#))

Command Syntax :TIMEbase:VERNier <vernier value>
<vernier value> ::= {{1 | ON} | {0 | OFF}}

The :TIMEbase:VERNier command specifies whether the time base control's vernier (fine horizontal adjustment) setting is ON (1) or OFF (0).

Query Syntax :TIMEbase:VERNier?

The :TIMEbase:VERNier? query returns the current state of the time base control's vernier setting.

Return Format <vernier value><NL>
<vernier value> ::= {0 | 1}

See Also • ["Introduction to :TIMEbase Commands"](#) on page 443

:TIMEbase:WINDow:POSition

C (see [page 740](#))

Command Syntax :TIMEbase:WINDow:POSition <pos value>

<pos value> ::= time from the trigger event to the zoomed (delayed) view reference point in NR3 format

The :TIMEbase:WINDow:POSition command sets the horizontal position in the zoomed (delayed) view of the main sweep. The main sweep range and the main sweep horizontal position determine the range for this command. The value for this command must keep the zoomed view window within the main sweep range.

Query Syntax :TIMEbase:WINDow:POSition?

The :TIMEbase:WINDow:POSition? query returns the current horizontal window position setting in the zoomed view.

Return Format <value><NL>

<value> ::= position value in seconds

- See Also**
- ["Introduction to :TIMEbase Commands"](#) on page 443
 - [":TIMEbase:MODE"](#) on page 444
 - [":TIMEbase:POSition"](#) on page 445
 - [":TIMEbase:RANGe"](#) on page 446
 - [":TIMEbase:SCALe"](#) on page 449
 - [":TIMEbase:WINDow:RANGe"](#) on page 452
 - [":TIMEbase:WINDow:SCALe"](#) on page 453

:TIMebase:WINDow:RANGe

C (see [page 740](#))

Command Syntax :TIMebase:WINDow:RANGe <range value>

<range value> ::= range value in seconds in NR3 format

The :TIMebase:WINDow:RANGe command sets the full-scale horizontal time in seconds for the zoomed (delayed) window. The range is 10 times the current zoomed view window seconds per division setting. The main sweep range determines the range for this command. The maximum value is one half of the :TIMebase:RANGe value.

Query Syntax :TIMebase:WINDow:RANGe?

The :TIMebase:WINDow:RANGe? query returns the current window timebase range setting.

Return Format <value><NL>

<value> ::= range value in seconds

- See Also**
- ["Introduction to :TIMebase Commands"](#) on page 443
 - [":TIMebase:RANGe"](#) on page 446
 - [":TIMebase:POSition"](#) on page 445
 - [":TIMebase:SCALE"](#) on page 449

:TIMEbase:WINDow:SCALE

N (see [page 740](#))

Command Syntax :TIMEbase:WINDow:SCALE <scale_value>

<scale_value> ::= scale value in seconds in NR3 format

The :TIMEbase:WINDow:SCALE command sets the zoomed (delayed) window horizontal scale (seconds/division). The main sweep scale determines the range for this command. The maximum value is one half of the :TIMEbase:SCALE value.

Query Syntax :TIMEbase:WINDow:SCALE?

The :TIMEbase:WINDow:SCALE? query returns the current zoomed window scale setting.

Return Format <scale_value><NL>

<scale_value> ::= current seconds per division for the zoomed window

- See Also**
- ["Introduction to :TIMEbase Commands"](#) on page 443
 - [":TIMEbase:RANGE"](#) on page 446
 - [":TIMEbase:POSition"](#) on page 445
 - [":TIMEbase:SCALE"](#) on page 449
 - [":TIMEbase:WINDow:RANGE"](#) on page 452

:TRIGger Commands

Control the trigger modes and parameters for each trigger type. See:

- "Introduction to :TRIGger Commands" on page 454
- "General :TRIGger Commands" on page 457
- ":TRIGger:CAN Commands" on page 465
- ":TRIGger:DURation Commands" on page 476
- ":TRIGger:EBURst Commands" on page 482
- ":TRIGger[:EDGE] Commands" on page 486
- ":TRIGger:FLEXray Commands" on page 492
- ":TRIGger:GLITCh Commands" on page 504 (Pulse Width trigger)
- ":TRIGger:IIC Commands" on page 513
- ":TRIGger:LIN Commands" on page 522
- ":TRIGger:SEQuence Commands" on page 530
- ":TRIGger:SPI Commands" on page 538
- ":TRIGger:TV Commands" on page 547
- ":TRIGger:USB Commands" on page 568
- ":TRIGger:UART Commands" on page 553

Introduction to :TRIGger Commands

The commands in the TRIGger subsystem define the conditions for an internal trigger. Many of these commands are valid in multiple trigger modes.

The default trigger mode is :EDGE.

The trigger subsystem controls the trigger sweep mode and the trigger specification. The trigger sweep (see ":TRIGger:SWEep" on page 464) can be AUTO or NORMAl.

- **NORMAl** mode displays a waveform only if a trigger signal is present and the trigger conditions are met. Otherwise the oscilloscope does not trigger and the display is not updated. This mode is useful for low-repetitive-rate signals.
- **AUTO** trigger mode generates an artificial trigger event if the trigger specification is not satisfied within a preset time, acquires unsynchronized data and displays it.

AUTO mode is useful for signals other than low-repetitive-rate signals. You must use this mode to display a DC signal because there are no edges on which to trigger.

The following trigger types are available (see ":TRIGger:MODE" on page 460).

- **CAN (Controller Area Network) triggering** will trigger on CAN version 2.0A and 2.0B signals. Setup consists of connecting the oscilloscope to a CAN signal. Baud rate, signal source, and signal polarity, and type of data to trigger on can be specified. With the automotive CAN and LIN serial decode option (Option ASM), you can also trigger on CAN data and identifier patterns, set the bit sample point, and have the module send an acknowledge to the bus when it receives a valid message.

NOTE

The CAN and LIN serial decode option (Option ASM) replaces the functionality that was available with the N2758A CAN trigger module for the 54620/54640 Series oscilloscopes.

- **Edge triggering** identifies a trigger by looking for a specified slope and voltage level on a waveform.
- **Nth Edge Burst triggering** lets you trigger on the Nth edge of a burst that occurs after an idle time.
- **Pulse width triggering** (:TRIGger:GLITch commands) sets the oscilloscope to trigger on a positive pulse or on a negative pulse of a specified width.
- **Pattern triggering** identifies a trigger condition by looking for a specified pattern. This pattern is a logical AND combination of the channels.
- **Duration triggering** lets you define a pattern, then trigger on a specified time duration.
- **FlexRay triggering** will, when used with a BusDoctor 2 protocol analyzer and a four-channel mixed-signal oscilloscope with Option FRS, trigger on FlexRay bus frames, times, or errors.
- **IIC (Inter-IC bus) triggering** consists of connecting the oscilloscope to the serial data (SDA) line and the serial clock (SCL) line, then triggering on a stop/start condition, a restart, a missing acknowledge, or on a read/write frame with a specific device address and data value.
- **LIN (Local Interconnect Network) triggering** will trigger on LIN sync break at the beginning of a message frame. With the automotive CAN and LIN serial decode option (Option ASM), you can also trigger on Frame IDs.

- **Sequence triggering** allows you to trigger the oscilloscope after finding a sequence of events. Defining a sequence trigger requires three steps:
 - a Define the event to find before you trigger on the next event. This event can be a pattern, and edge from a single channel, or the combination of a pattern and a channel edge.
 - b Define the trigger event. This event can be a pattern, and edge from a single channel, the combination of a pattern and a channel edge, or the nth occurrence of an edge from a single channel.
 - c Set an optional reset event. This event can be a pattern, an edge from a single channel, the combination of a pattern and a channel edge, or a timeout value.
- **SPI (Serial Peripheral Interface) triggering** consists of connecting the oscilloscope to a clock, data, and framing signal. You can then trigger on a data pattern during a specific framing period. The serial data string can be specified to be from 4 to 32 bits long.
- **TV triggering** is used to capture the complicated waveforms of television equipment. The trigger circuitry detects the vertical and horizontal interval of the waveform and produces triggers based on the TV trigger settings you selected. TV triggering requires greater than $\frac{1}{2}$ division of sync amplitude with any analog channel as the trigger source.
- **UART/RS-232 triggering** (with Option 232) lets you trigger on RS-232 serial data.
- **USB (Universal Serial Bus) triggering** will trigger on a Start of Packet (SOP), End of Packet (EOP), Reset Complete, Enter Suspend, or Exit Suspend signal on the differential USB data lines. USB Low Speed and Full Speed are supported by this trigger.

Reporting the Setup

Use `:TRIGger?` to query setup information for the TRIGger subsystem.

Return Format

The return format for the `TRIGger?` query varies depending on the current mode. The following is a sample response from the `:TRIGger?` query. In this case, the query was issued following a `*RST` command.

```
:TRIG:MODE EDGE;SWE AUTO;NREJ 0;HFR 0;HOLD +60.00000000000000E-09;  
:TRIG:EDGE:SOUR CHAN1;LEV +0.00000E+00;SLOP POS;REJ OFF;COUP DC
```

General :TRIGger Commands

Table 71 General :TRIGger Commands Summary

Command	Query	Options and Query Returns
:TRIGger:HFReject {{0 OFF} {1 ON}} (see page 458)	:TRIGger:HFReject? (see page 458)	{0 1}
:TRIGger:HOLDoff <holdoff_time> (see page 459)	:TRIGger:HOLDoff? (see page 459)	<holdoff_time> ::= 60 ns to 10 s in NR3 format
:TRIGger:MODE <mode> (see page 460)	:TRIGger:MODE? (see page 460)	<mode> ::= {EDGE GLITCh PATtern CAN DURation IIC EBURst LIN SEquence SPI TV USB FLEXray} <return_value> ::= {<mode> <none>} <none> ::= query returns "NONE" if the :TIMEbase:MODE is ROLL or XY
:TRIGger:NREJect {{0 OFF} {1 ON}} (see page 461)	:TRIGger:NREJect? (see page 461)	{0 1}
:TRIGger:PATtern <value>, <mask> [, <edge source>, <edge>] (see page 462)	:TRIGger:PATtern? (see page 463)	<value> ::= integer in NR1 format or <string> <mask> ::= integer in NR1 format or <string> <string> ::= "0xnxxxxn"; n ::= {0,...,9 A,...,F} (# bits = # channels) <edge source> ::= {CHANnel<n> EXTernal NONE} for DSO models <edge source> ::= {CHANnel<n> DIGital0,...,DIGital15 NONE} for MSO models <edge> ::= {POSitive NEGative} <n> ::= 1-2 or 1-4 in NR1 format
:TRIGger:SWEep <sweep> (see page 464)	:TRIGger:SWEep? (see page 464)	<sweep> ::= {AUTO NORMal}

:TRIGger:HFReject

C (see [page 740](#))

Command Syntax :TRIGger:HFReject <value>
<value> ::= {{0 | OFF} | {1 | ON}}

The :TRIGger:HFReject command turns the high frequency reject filter off and on. The high frequency reject filter adds a 50 kHz low-pass filter in the trigger path to remove high frequency components from the trigger waveform. Use this filter to remove high-frequency noise, such as AM or FM broadcast stations, from the trigger path.

Query Syntax :TRIGger:HFReject?

The :TRIGger:HFReject? query returns the current high frequency reject filter mode.

Return Format <value><NL>
<value> ::= {0 | 1}

- See Also**
- "[Introduction to :TRIGger Commands](#)" on page 454
 - "[:TRIGger\[:EDGE\]:REJECT](#)" on page 489

:TRIGger:HOLDoff

C (see [page 740](#))

Command Syntax :TRIGger:HOLDoff <holdoff_time>
 <holdoff_time> ::= 60 ns to 10 s in NR3 format

The :TRIGger:HOLDoff command defines the holdoff time value in seconds. Holdoff keeps a trigger from occurring until after a certain amount of time has passed since the last trigger. This feature is valuable when a waveform crosses the trigger level multiple times during one period of the waveform. Without holdoff, the oscilloscope could trigger on each of the crossings, producing a confusing waveform. With holdoff set correctly, the oscilloscope always triggers on the same crossing. The correct holdoff setting is typically slightly less than one period.

Query Syntax :TRIGger:HOLDoff?

The :TRIGger:HOLDoff? query returns the holdoff time value for the current trigger mode.

Return Format <holdoff_time><NL>
 <holdoff_time> ::= the holdoff time value in seconds in NR3 format.

See Also • ["Introduction to :TRIGger Commands"](#) on page 454

:TRIGger:MODE

C (see [page 740](#))

Command Syntax :TRIGger:MODE <mode>

```
<mode> ::= {EDGE | GLITch | PATTern | CAN | DURation | IIC | EBURst
            | LIN | SEQuence | SPI | TV | USB | FLEXray | UART}
```

The :TRIGger:MODE command selects the trigger mode (trigger type).

Query Syntax :TRIGger:MODE?

The :TRIGger:MODE? query returns the current trigger mode. If the :TIMEbase:MODE is ROLL or XY, the query returns "NONE."

Return Format <mode><NL>

```
<mode> ::= {NONE | EDGE | GLIT | PATT | CAN | DUR | IIC
            | EBUR | LIN | SEQ | SPI | TV | USB | FLEX | UART}
```

- See Also**
- ["Introduction to :TRIGger Commands" on page 454](#)
 - [":TRIGger:SWEep" on page 464](#)
 - [":TIMEbase:MODE" on page 444](#)

Example Code

```
' TRIGGER_MODE - Set the trigger mode to EDGE, GLITch, PATTern, CAN,
' DURation, IIC, EBURst, LIN, SEQuence, SPI, TV, USB, FLEXray, or
' UART.

' Set the trigger mode to EDGE.
myScope.WriteString ":TRIGGER:MODE EDGE"
```

Example program from the start: ["VISA COM Example in Visual Basic" on page 828](#)

:TRIGger:NREJect

C (see [page 740](#))

Command Syntax :TRIGger:NREJect <value>
<value> ::= {{0 | OFF} | {1 | ON}}

The :TRIGger:NREJect command turns the noise reject filter off and on. When the noise reject filter is on, the trigger circuitry is less sensitive to noise but may require a greater amplitude waveform to trigger the oscilloscope. This command is not valid in TV trigger mode.

Query Syntax :TRIGger:NREJect?

The :TRIGger:NREJect? query returns the current noise reject filter mode.

Return Format <value><NL>
<value> ::= {0 | 1}

See Also • ["Introduction to :TRIGger Commands"](#) on page 454

:TRIGger:PATtern

C (see page 740)

Command Syntax :TRIGger:PATtern <pattern>

<pattern> ::= <value>, <mask> [, <edge source>, <edge>]

<value> ::= integer in NR1 format or <string>

<mask> ::= integer in NR1 format or <string>

<string> ::= "0xnxxxxn"; n ::= {0,...,9 | A,...,F}
(# bits = # channels, see following table)

<edge source> ::= {CHANnel<n> | EXTERNAL | NONE} for DSO models

<edge source> ::= {CHANnel<n> | DIGital0,...,DIGital15
| NONE} for MSO models

<n> ::= {1 | 2 | 3 | 4} for the four channel oscilloscope models

<n> ::= {1 | 2} for the two channel oscilloscope models

<edge> ::= {POSitive | NEGative}

The :TRIGger:PATtern command defines the specified pattern resource according to the value and the mask. For both <value> and <mask>, each bit corresponds to a possible trigger channel. The bit assignments vary by instrument:

Oscilloscope Models	Value and Mask Bit Assignments
4 analog + 16 digital channels (mixed-signal)	Bits 0 through 15 - digital channels 0 through 15. Bits 16 through 19 - analog channels 1 through 4.
2 analog + 16 digital channels (mixed-signal)	Bits 0 through 15 - digital channels 0 through 15. Bits 16 and 17 - analog channels 1 and 2.
4 analog channels only	Bits 0 through 3 - analog channels 1 through 4. Bit 4 - external trigger.
2 analog channels only	Bits 0 and 1 - analog channels 1 and 2. Bit 4 - external trigger.

Set a <value> bit to "0" to set the pattern for the corresponding channel to low. Set a <value> bit to "1" to set the pattern to high.

Set a <mask> bit to "0" to ignore the data for the corresponding channel. Only channels with a "1" set on the appropriate mask bit are used.

NOTE

The optional source and the optional edge should be sent together or not at all. The edge will be set in the simple pattern if it is included. If the edge source is also specified in the mask, the edge takes precedence.

Query Syntax `:TRIGger:PATtern?`

The `:TRIGger:PATtern?` query returns the pattern value, the mask, and the edge of interest in the simple pattern.

Return Format `<pattern><NL>`

- See Also**
- ["Introduction to :TRIGger Commands"](#) on page 454
 - [":TRIGger:MODE"](#) on page 460

:TRIGger:SWEEp

C (see [page 740](#))

Command Syntax :TRIGger:SWEEp <sweep>
<sweep> ::= {AUTO | NORMal}

The :TRIGger:SWEEp command selects the trigger sweep mode.

When AUTO sweep mode is selected, a baseline is displayed in the absence of a signal. If a signal is present but the oscilloscope is not triggered, the unsynchronized signal is displayed instead of a baseline.

When NORMal sweep mode is selected and no trigger is present, the instrument does not sweep, and the data acquired on the previous trigger remains on the screen.

NOTE

This feature is called "Mode" on the instrument's front panel.

Query Syntax :TRIGger:SWEEp?

The :TRIGger:SWEEp? query returns the current trigger sweep mode.

Return Format <sweep><NL>
<sweep> ::= current trigger sweep mode

See Also • ["Introduction to :TRIGger Commands"](#) on page 454

:TRIGger:CAN Commands

Table 72 :TRIGger:CAN Commands Summary

Command	Query	Options and Query Returns
:TRIGger:CAN:PAATtern:DATA <value>, <mask> (see page 467)	:TRIGger:CAN:PAATtern:DATA? (see page 467)	<value> ::= 64-bit integer in decimal, <nondecimal>, or <string> (with Option AMS) <mask> ::= 64-bit integer in decimal, <nondecimal>, or <string> <nondecimal> ::= #Hnn...n where n ::= {0,...,9 A,...,F} for hexadecimal <nondecimal> ::= #Bnn...n where n ::= {0 1} for binary <string> ::= "0xnn...n" where n ::= {0,...,9 A,...,F} for hexadecimal
:TRIGger:CAN:PAATtern:DATA:LENGth <length> (see page 468)	:TRIGger:CAN:PAATtern:DATA:LENGth? (see page 468)	<length> ::= integer from 1 to 8 in NR1 format (with Option AMS)
:TRIGger:CAN:PAATtern:ID <value>, <mask> (see page 469)	:TRIGger:CAN:PAATtern:ID? (see page 469)	<value> ::= 32-bit integer in decimal, <nondecimal>, or <string> (with Option AMS) <mask> ::= 32-bit integer in decimal, <nondecimal>, or <string> <nondecimal> ::= #Hnn...n where n ::= {0,...,9 A,...,F} for hexadecimal <nondecimal> ::= #Bnn...n where n ::= {0 1} for binary <string> ::= "0xnn...n" where n ::= {0,...,9 A,...,F} for hexadecimal
:TRIGger:CAN:PAATtern:ID:MODE <value> (see page 470)	:TRIGger:CAN:PAATtern:ID:MODE? (see page 470)	<value> ::= {STANdard EXTENDED} (with Option AMS)
:TRIGger:CAN:SAMPlepo int <value> (see page 471)	:TRIGger:CAN:SAMPlepo int? (see page 471)	<value> ::= {60 62.5 68 70 75 80 87.5} in NR3 format
:TRIGger:CAN:SIGNAL:B AUDRate <baudrate> (see page 472)	:TRIGger:CAN:SIGNAL:B AUDRate? (see page 472)	<baudrate> ::= integer from 10000 to 1000000 in 100 b/s increments

5 Commands by Subsystem

Table 72 :TRIGger:CAN Commands Summary (continued)

Command	Query	Options and Query Returns
:TRIGger:CAN:SOURce <source> (see page 473)	:TRIGger:CAN:SOURce? (see page 473)	<source> ::= {CHANnel<n> EXTernal} for DSO models <source> ::= {CHANnel<n> DIGital0,...,DIGital15 } for MSO models <n> ::= 1-2 or 1-4 in NR1 format
:TRIGger:CAN:TRIGger <condition> (see page 474)	:TRIGger:CAN:TRIGger? (see page 475)	<condition> ::= {SOF} (without Option AMS) <condition> ::= {SOF DATA ERRor IDData IDEither IDRemote ALLerrors OVERload ACKerror} (with Option AMS)

:TRIGger:CAN:PATtern:DATA

N (see [page 740](#))

Command Syntax :TRIGger:CAN:PATtern:DATA <value>,<mask>
 <value> ::= 64-bit integer in decimal, <nondecimal>, or <string>
 <mask> ::= 64-bit integer in decimal, <nondecimal>, or <string>
 <nondecimal> ::= #Hnn...n where n ::= {0,...,9 | A,...,F} for hexadecimal
 <nondecimal> ::= #Bnn...n where n ::= {0 | 1} for binary
 <string> ::= "0xnn...n" where n ::= {0,...,9 | A,...,F} for hexadecimal

The :TRIGger:CAN:PATtern:DATA command defines the CAN data pattern resource according to the value and the mask. This pattern, along with the data length (set by the :TRIGger:CAN:PATtern:DATA:LENGth command), control the data pattern searched for in each CAN message.

Set a <value> bit to "0" to set the corresponding bit in the data pattern to low. Set a <value> bit to "1" to set the bit to high.

Set a <mask> bit to "0" to ignore that bit in the data stream. Only bits with a "1" set on the mask are used.

NOTE

If more bytes are sent for <value> or <mask> than specified by the :TRIGger:CAN:PATtern:DATA:LENGth command, the most significant bytes will be truncated. If the data length is changed after the <value> and <mask> are programmed, the added or deleted bytes will be added to or deleted from the least significant bytes.

NOTE

This command is only valid when the automotive CAN and LIN serial decode option (Option AMS) has been licensed.

Query Syntax :TRIGger:CAN:PATtern:DATA?

The :TRIGger:CAN:PATtern:DATA? query returns the current settings of the specified CAN data pattern resource.

Return Format <value>,<mask><NL> in nondecimal format

Errors • ["-241, Hardware missing"](#) on page 699

See Also • ["Introduction to :TRIGger Commands"](#) on page 454
 • [":TRIGger:CAN:PATtern:DATA:LENGth"](#) on page 468
 • [":TRIGger:CAN:PATtern:ID"](#) on page 469

:TRIGger:CAN:PATtern:DATA:LENGth

N (see [page 740](#))

Command Syntax :TRIGger:CAN:PATtern:DATA:LENGth <length>
<length> ::= integer from 1 to 8 in NR1 format

The :TRIGger:CAN:PATtern:DATA:LENGth command sets the number of 8-bit bytes in the CAN data string. The number of bytes in the string can be anywhere from 0 bytes to 8 bytes (64 bits). The value for these bytes is set by the :TRIGger:CAN:PATtern:DATA command.

NOTE

This command is only valid when the automotive CAN and LIN serial decode option (Option AMS) has been licensed.

Query Syntax :TRIGger:CAN:PATtern:DATA:LENGth?

The :TRIGger:CAN:PATtern:DATA:LENGth? query returns the current CAN data pattern length setting.

Return Format <count><NL>
<count> ::= integer from 1 to 8 in NR1 format

Errors • "-241, Hardware missing" on [page 699](#)

See Also • "Introduction to :TRIGger Commands" on [page 454](#)
• ":TRIGger:CAN:PATtern:DATA" on [page 467](#)
• ":TRIGger:CAN:SOURce" on [page 473](#)

:TRIGger:CAN:PATtern:ID

N (see [page 740](#))

Command Syntax :TRIGger:CAN:PATtern:ID <value>, <mask>

<value> ::= 32-bit integer in decimal, <nondecimal>, or <string>

<mask> ::= 32-bit integer in decimal, <nondecimal>, or <string>

<nondecimal> ::= #Hnn...n where n ::= {0,...,9 | A,...,F} for hexadecimal

<nondecimal> ::= #Bnn...n where n ::= {0 | 1} for binary

<string> ::= "0xnn...n" where n ::= {0,...,9 | A,...,F} for hexadecimal

The :TRIGger:CAN:PATtern:ID command defines the CAN identifier pattern resource according to the value and the mask. This pattern, along with the identifier mode (set by the :TRIGger:CAN:PATtern:ID:MODE command), control the identifier pattern searched for in each CAN message.

Set a <value> bit to "0" to set the corresponding bit in the identifier pattern to low. Set a <value> bit to "1" to set the bit to high.

Set a <mask> bit to "0" to ignore that bit in the identifier stream. Only bits with a "1" set on the mask are used.

NOTE

If more bits are sent than allowed (11 bits in standard mode, 29 bits in extended mode) by the :TRIGger:CAN:PATtern:ID:MODE command, the most significant bytes will be truncated. If the ID mode is changed after the <value> and <mask> are programmed, the added or deleted bits will be added to or deleted from the most significant bits.

NOTE

This command is only valid when the automotive CAN and LIN serial decode option (Option AMS) has been licensed.

Query Syntax :TRIGger:CAN:PATtern:ID?

The :TRIGger:CAN:PATtern:ID? query returns the current settings of the specified CAN identifier pattern resource.

Return Format <value>, <mask><NL> in nondecimal format

Errors

- "-241, Hardware missing" on [page 699](#)

See Also

- "[Introduction to :TRIGger Commands](#)" on [page 454](#)
- ":TRIGger:CAN:PATtern:ID:MODE" on [page 470](#)
- ":TRIGger:CAN:PATtern:DATA" on [page 467](#)

:TRIGger:CAN:PATtern:ID:MODE

N (see [page 740](#))

Command Syntax :TRIGger:CAN:PATtern:ID:MODE <value>
<value> ::= {STANdard | EXTended}

The :TRIGger:CAN:PATtern:ID:MODE command sets the CAN identifier mode. STANdard selects the standard 11-bit identifier. EXTended selects the extended 29-bit identifier. The CAN identifier is set by the :TRIGger:CAN:PATtern:ID command.

NOTE

This command is only valid when the automotive CAN and LIN serial decode option (Option AMS) has been licensed.

Query Syntax :TRIGger:CAN:PATtern:ID:MODE?

The :TRIGger:CAN:PATtern:ID:MODE? query returns the current setting of the CAN identifier mode.

Return Format <value><NL>
<value> ::= {STAN | EXT}

Errors • "-241, Hardware missing" on [page 699](#)

- See Also**
- "[Introduction to :TRIGger Commands](#)" on [page 454](#)
 - "[:TRIGger:MODE](#)" on [page 460](#)
 - "[:TRIGger:CAN:PATtern:DATA](#)" on [page 467](#)
 - "[:TRIGger:CAN:PATtern:DATA:LENGth](#)" on [page 468](#)
 - "[:TRIGger:CAN:PATtern:ID](#)" on [page 469](#)

:TRIGger:CAN:SAMPlEpoint

N (see [page 740](#))

Command Syntax :TRIGger:CAN:SAMPlEpoint <value>

<value><NL>

<value> ::= {60 | 62.5 | 68 | 70 | 75 | 80 | 87.5} in NR3 format

The :TRIGger:CAN:SAMPlEpoint command sets the point during the bit time where the bit level is sampled to determine whether the bit is dominant or recessive. The sample point represents the percentage of time between the beginning of the bit time to the end of the bit time.

Query Syntax :TRIGger:CAN:SAMPlEpoint?

The :TRIGger:CAN:SAMPlEpoint? query returns the current CAN sample point setting.

Return Format <value><NL>

<value> ::= {60 | 62.5 | 68 | 70 | 75 | 80 | 87.5} in NR3 format

- See Also**
- ["Introduction to :TRIGger Commands"](#) on page 454
 - [":TRIGger:MODE"](#) on page 460
 - [":TRIGger:CAN:TRIGger"](#) on page 474

:TRIGger:CAN:SIGNal:BAUDrate

N (see [page 740](#))

Command Syntax :TRIGger:CAN:SIGNal:BAUDrate <baudrate>

<baudrate> ::= integer from 10000 to 1000000 in 100 b/s increments

The :TRIGger:CAN:SIGNal:BAUDrate command sets the standard baud rate of the CAN signal from 10 kb/s to 1 Mb/s in 100 b/s increments. If you enter a baud rate that is not divisible by 100 b/s, the baud rate is set to the nearest baud rate divisible by 100 b/s.

If the baud rate you select does not match the system baud rate, false triggers may occur.

Query Syntax :TRIGger:CAN:SIGNal:BAUDrate?

The :TRIGger:CAN:SIGNal:BAUDrate? query returns the current CAN baud rate setting.

Return Format <baudrate><NL>

<baudrate> ::= integer from 10000 to 1000000 in 100 b/s increments

- See Also**
- "[Introduction to :TRIGger Commands](#)" on page 454
 - "[:TRIGger:MODE](#)" on page 460
 - "[:TRIGger:CAN:TRIGger](#)" on page 474
 - "[:TRIGger:CAN:SIGNal:DEFinition](#)" on page 692
 - "[:TRIGger:CAN:SOURce](#)" on page 473

:TRIGger:CAN:SOURce

N (see [page 740](#))

Command Syntax :TRIGger:CAN:SOURce <source>

<source> ::= {CHANnel<n> | EXTernal} for the DSO models

<source> ::= {CHANnel<n> | DIGital0,...,DIGital15} for the MSO models

<n> ::= {1 | 2 | 3 | 4} for the four channel oscilloscope models

<n> ::= {1 | 2} for the two channel oscilloscope models

The :TRIGger:CAN:SOURce command sets the source for the CAN signal. The source setting is only valid when :TRIGger:CAN:TRIGger is set to SOF (start of frame).

Query Syntax :TRIGger:CAN:SOURce?

The :TRIGger:CAN:SOURce? query returns the current source for the CAN signal.

Return Format <source><NL>

- See Also**
- ["Introduction to :TRIGger Commands"](#) on page 454
 - [":TRIGger:MODE"](#) on page 460
 - [":TRIGger:CAN:TRIGger"](#) on page 474
 - [":TRIGger:CAN:SIGNal:DEFinition"](#) on page 692

:TRIGger:CAN:TRIGger

N (see page 740)

Command Syntax :TRIGger:CAN:TRIGger <condition>

```
<condition> ::= {SOF | DATA | ERRor | IDData | IDEither | IDRemote |
                ALLerrors | OVERload | ACKerror}
```

The :TRIGger:CAN:TRIGger command sets the CAN trigger on condition:

- SOF - will trigger on the Start of Frame (SOF) bit of a Data frame, Remote Transfer Request (RTR) frame, or an Overload frame.
- DATA - will trigger on CAN Data frames matching the specified Id, Data, and the DLC (Data length code).
- ERRor - will trigger on CAN Error frame.
- IDData - will trigger on CAN frames matching the specified Id of a Data frame.
- IDEither - will trigger on the specified Id, regardless if it is a Remote frame or a Data frame.
- IDRemote - will trigger on CAN frames matching the specified Id of a Remote frame.
- ALLerrors - will trigger on CAN active error frames and unknown bus conditions.
- OVERload - will trigger on CAN overload frames.
- ACKerror - will trigger on a data or remote frame acknowledge bit that is recessive.

The table below shows the programming parameter and the corresponding front-panel softkey selection:

Remote <condition> parameter	Front-panel Trigger on: softkey selection (softkey text - softkey popup text)
SOF	SOF - Start of Frame
DATA	Id & Data - Data Frame Id and Data
ERRor	Error - Error frame
IDData	Id & ~RTR - Data Frame Id (~RTR)
IDEither	Id - Remote or Data Frame Id
IDRemote	Id & RTR - Remote Frame Id (RTR)
ALLerrors	All Errors - All Errors
OVERload	Overload - Overload Frame
ACKerror	Ack Error - Acknowledge Error

CAN Id specification is set by the `:TRIGger:CAN:PATtern:ID` and `:TRIGger:CAN:PATtern:ID:MODE` commands.

CAN Data specification is set by the `:TRIGger:CAN:PATtern:DATA` command.

CAN Data Length Code is set by the `:TRIGger:CAN:PATtern:DATA:LENGth` command.

NOTE

SOF is the only valid selection for analog oscilloscopes. If the automotive CAN and LIN serial decode option (Option AMS) has not been licensed, SOF is the only valid selection.

Query Syntax `:TRIGger:CAN:TRIGger?`

The `:TRIGger:CAN:TRIGger?` query returns the current CAN trigger on condition.

Return Format `<condition><NL>`

`<condition> ::= {SOF | DATA | ERR | IDD | IDE | IDR | ALL | OVER | ACK}`

Errors

- ["-241, Hardware missing"](#) on page 699

See Also

- ["Introduction to :TRIGger Commands"](#) on page 454
- [":TRIGger:MODE"](#) on page 460
- [":TRIGger:CAN:PATtern:DATA"](#) on page 467
- [":TRIGger:CAN:PATtern:DATA:LENGth"](#) on page 468
- [":TRIGger:CAN:PATtern:ID"](#) on page 469
- [":TRIGger:CAN:PATtern:ID:MODE"](#) on page 470
- [":TRIGger:CAN:SIGNal:DEFinition"](#) on page 692
- [":TRIGger:CAN:SOURce"](#) on page 473

:TRIGger:DURation Commands

Table 73 :TRIGger:DURation Commands Summary

Command	Query	Options and Query Returns
:TRIGger:DURation:GREaterthan <greater than time>[suffix] (see page 477)	:TRIGger:DURation:GREaterthan? (see page 477)	<greater_than_time> ::= floating-point number in NR3 format [suffix] ::= {s ms us ns ps}
:TRIGger:DURation:LESSthan <less than time>[suffix] (see page 478)	:TRIGger:DURation:LESSthan? (see page 478)	<less_than_time> ::= floating-point number from in NR3 format [suffix] ::= {s ms us ns ps}
:TRIGger:DURation:PATTERN <value>, <mask> (see page 479)	:TRIGger:DURation:PATTERN? (see page 479)	<value> ::= integer or <string> <mask> ::= integer or <string> <string> ::= "0xnxxxxxx" n ::= {0,...,9 A,...,F}
:TRIGger:DURation:QUALifier <qualifier> (see page 480)	:TRIGger:DURation:QUALifier? (see page 480)	<qualifier> ::= {GREaterthan LESSthan INRange OUTRange TIMEout}
:TRIGger:DURation:RANGE <less_than_time>[suffix], <greater_than_time>[suffix] (see page 481)	:TRIGger:DURation:RANGE? (see page 481)	<less_than_time> ::= 15 ns to 10 seconds in NR3 format <greater_than_time> ::= 10 ns to 9.99 seconds in NR3 format [suffix] ::= {s ms us ns ps}

:TRIGger:DURation:GREaterthan**N** (see [page 740](#))**Command Syntax** :TRIGger:DURation:GREaterthan <greater_than_time> [<suffix>]<greater_than_time> ::= minimum trigger duration in seconds
in NR3 format

<suffix> ::= {s | ms | us | ns | ps }

The :TRIGger:DURation:GREaterthan command sets the minimum duration for the defined pattern when :TRIGger:DURation:QUALifier is set to GREaterthan. The command also sets the timeout value when the :TRIGger:DURation:QUALifier is set to TIMEout.

Query Syntax :TRIGger:DURation:GREaterthan?

The :TRIGger:DURation:GREaterthan? query returns the minimum duration time for the defined pattern.

Return Format <greater_than_time><NL>

- See Also**
- "[Introduction to :TRIGger Commands](#)" on page 454
 - "[:TRIGger:DURation:PATtern](#)" on page 479
 - "[:TRIGger:DURation:QUALifier](#)" on page 480
 - "[:TRIGger:MODE](#)" on page 460

:TRIGger:DURation:LESSthan

N (see [page 740](#))

Command Syntax :TRIGger:DURation:LESSthan <less_than_time>[<suffix>]
<less_than_time> ::= maximum trigger duration in seconds
in NR3 format
<suffix> ::= {s | ms | us | ns | ps}

The :TRIGger:DURation:LESSthan command sets the maximum duration for the defined pattern when :TRIGger:DURation:QUALifier is set to LESSthan.

Query Syntax :TRIGger:DURation:LESSthan?

The :TRIGger:DURation:LESSthan? query returns the duration time for the defined pattern.

Return Format <less_than_time><NL>

- See Also**
- "[Introduction to :TRIGger Commands](#)" on page 454
 - "[:TRIGger:DURation:PATtern](#)" on page 479
 - "[:TRIGger:DURation:QUALifier](#)" on page 480
 - "[:TRIGger:MODE](#)" on page 460

:TRIGger:DURation:PATtern

N (see [page 740](#))

Command Syntax :TRIGger:DURation:PATtern <value>, <mask>
 <value> ::= integer or <string>
 <mask> ::= integer or <string>
 <string> ::= "0xnmmnnn"; n ::= {0,...,9 | A,...,F}

The :TRIGger:DURation:PATtern command defines the specified duration pattern resource according to the value and the mask. For both <value> and <mask>, each bit corresponds to a possible trigger channel. The bit assignments vary by instrument:

Oscilloscope Models	Value and Mask Bit Assignments
4 analog + 16 digital channels (mixed-signal)	Bits 0 through 15 - digital channels 0 through 15. Bits 16 through 19 - analog channels 1 through 4.
2 analog + 16 digital channels (mixed-signal)	Bits 0 through 15 - digital channels 0 through 15. Bits 16 and 17 - analog channels 1 and 2.
4 analog channels only	Bits 0 through 3 - analog channels 1 through 4. Bit 4 - external trigger.
2 analog channels only	Bits 0 and 1 - analog channels 1 and 2. Bit 4 - external trigger.

Set a <value> bit to "0" to set the pattern for the corresponding channel to low. Set a <value> bit to "1" to set the pattern to high.

Set a <mask> bit to "0" to ignore the data for the corresponding channel. Only channels with a "1" set on the appropriate mask bit are used.

Query Syntax :TRIGger:DURation:PATtern?

The :TRIGger:DURation:PATtern? query returns the pattern value.

Return Format <value>, <mask><NL>
 <value> ::= a 32-bit integer in NR1 format.
 <mask> ::= a 32-bit integer in NR1 format.

- See Also**
- ["Introduction to :TRIGger Commands"](#) on page 454
 - [":TRIGger:PATtern"](#) on page 462

:TRIGger:DURation:QUALifier

N (see [page 740](#))

Command Syntax :TRIGger:DURation:QUALifier <qualifier>

<qualifier> ::= {GREaterthan | LESSthan | INRange | OUTRange | TIMEout}

The :TRIGger:DURation:QUALifier command qualifies the trigger duration.

Set the GREaterthan qualifier value with the :TRIGger:DURation:GREaterthan command.

Set the LESSthan qualifier value with the :TRIGger:DURation:LESSthan command.

Set the INRange and OUTRange qualifier values with the :TRIGger:DURation:RANGE command.

Set the TIMEout qualifier value with the :TRIGger:DURation:GREaterthan command.

Query Syntax :TRIGger:DURation:QUALifier?

The :TRIGger:DURation:QUALifier? query returns the trigger duration qualifier.

Return Format <qualifier><NL>

- See Also**
- ["Introduction to :TRIGger Commands"](#) on page 454
 - [":TRIGger:DURation:GREaterthan"](#) on page 477
 - [":TRIGger:DURation:LESSthan"](#) on page 478
 - [":TRIGger:DURation:RANGE"](#) on page 481

:TRIGger:DURation:RANGe

N (see [page 740](#))

Command Syntax `:TRIGger:DURation:RANGe <less_than_time>[<suffix>],
<greater_than_time>[<suffix>]`

`<greater_than_time> ::= 10 ns to 9.99 seconds in NR3 format`

`<less_than_time> ::= 15 ns to 10 seconds in NR3 format`

`<suffix> ::= {s | ms | us | ns | ps}`

The `:TRIGger:DURation:RANGe` command sets the duration for the defined pattern when the `:TRIGger:DURation:QUALifier` command is set to `INRange` or `OUTRange`. You can enter the parameters in any order – the smaller value becomes the `<greater_than_time>` and the larger value becomes the `<less_than_time>`.

Query Syntax `:TRIGger:DURation:RANGe?`

The `:TRIGger:DURation:RANGe?` query returns the duration time for the defined pattern.

Return Format `<less_than_time>,<greater_than_time><NL>`

- See Also**
- "[Introduction to :TRIGger Commands](#)" on page 454
 - "[:TRIGger:DURation:PATtern](#)" on page 479
 - "[:TRIGger:DURation:QUALifier](#)" on page 480
 - "[:TRIGger:MODE](#)" on page 460

:TRIGger:EBURst Commands**Table 74** :TRIGger:EBURst Commands Summary

Command	Query	Options and Query Returns
:TRIGger:EBURst:COUNT <count> (see page 483)	:TRIGger:EBURst:COUNT? (see page 483)	<count> ::= integer in NR1 format
:TRIGger:EBURst:IDLE <time_value> (see page 484)	:TRIGger:EBURst:IDLE? (see page 484)	<time_value> ::= time in seconds in NR3 format
:TRIGger:EBURst:SLOPe <slope> (see page 485)	:TRIGger:EBURst:SLOPe? (see page 485)	<slope> ::= {NEGative POSitive}

The :TRIGger:EDGE:SOURce command is used to specify the source channel for the Nth Edge Burst trigger. If an analog channel is selected as the source, the :TRIGger:EDGE:LEVel command is used to set the Nth Edge Burst trigger level. If a digital channel is selected as the source, the :DIGital<n>:THReshold or :POD<n>:THReshold command is used to set the Nth Edge Burst trigger level.

:TRIGger:EBURst:COUNT

N (see [page 740](#))

Command Syntax :TRIGger:EBURst:COUNT <count>

<count> ::= integer in NR1 format

The :TRIGger:EBURst:COUNT command sets the Nth edge at burst counter resource. The edge counter is used in the trigger stage to determine which edge in a burst will generate a trigger.

Query Syntax :TRIGger:EBURst:COUNT?

The :TRIGger:EBURst:COUNT? query returns the current Nth edge of burst edge counter setting.

Return Format <count><NL>

<count> ::= integer in NR1 format

- See Also**
- "[Introduction to :TRIGger Commands](#)" on page 454
 - "[:TRIGger:EBURst:SLOPe](#)" on page 485
 - "[:TRIGger:EBURst:IDLE](#)" on page 484

:TRIGger:EBURst:IDLE

N (see [page 740](#))

Command Syntax :TRIGger:EBURst:IDLE <time_value>

<time_value> ::= time in seconds in NR3 format

The :TRIGger:EBURst:IDLE command sets the Nth edge in a burst idle resource in seconds from 10 ns to 10 s. The timer is used to set the minimum time before the next burst.

Query Syntax :TRIGger:EBURst:IDLE?

The :TRIGger:EBURst:IDLE? query returns current Nth edge in a burst idle setting.

Return Format <time value><NL>

<time_value> ::= time in seconds in NR3 format

- See Also**
- "[Introduction to :TRIGger Commands](#)" on page 454
 - "[:TRIGger:EBURst:SLOPe](#)" on page 485
 - "[:TRIGger:EBURst:COUnT](#)" on page 483

:TRIGger:EBURst:SLOPe

N (see [page 740](#))

Command Syntax :TRIGger:EBURst:SLOPe <slope>

<slope> ::= {NEGative | POSitive}

The :TRIGger:EBURst:SLOPe command specifies whether the rising edge (POSitive) or falling edge (NEGative) of the Nth edge in a burst will generate a trigger.

Query Syntax :TRIGger:EBURst:SLOPe?

The :TRIGger:EBURst:SLOPe? query returns the current Nth edge in a burst slope.

Return Format <slope><NL>

<slope> ::= {NEG | POS}

- See Also**
- "[Introduction to :TRIGger Commands](#)" on page 454
 - "[:TRIGger:EBURst:IDLE](#)" on page 484
 - "[:TRIGger:EBURst:COUNT](#)" on page 483

:TRIGger[:EDGE] Commands

Table 75 :TRIGger[:EDGE] Commands Summary

Command	Query	Options and Query Returns
:TRIGger[:EDGE]:COUPling {AC DC LF} (see page 487)	:TRIGger[:EDGE]:COUPling? (see page 487)	{AC DC LF}
:TRIGger[:EDGE]:LEVel <level> [, <source>] (see page 488)	:TRIGger[:EDGE]:LEVel ? [<source>] (see page 488)	For internal triggers, <level> ::= .75 x full-scale voltage from center screen in NR3 format. For external triggers, <level> ::= ±(external range setting) in NR3 format. For digital channels (MSO models), <level> ::= ±8 V. <source> ::= {CHANnel<n> EXTernal} for DSO models <source> ::= {CHANnel<n> DIGital0,..,DIGital15 EXTernal} for MSO models <n> ::= 1-2 or 1-4 in NR1 format
:TRIGger[:EDGE]:REJect {OFF LF HF} (see page 489)	:TRIGger[:EDGE]:REJect? (see page 489)	{OFF LF HF}
:TRIGger[:EDGE]:SLOPe <polarity> (see page 490)	:TRIGger[:EDGE]:SLOPe ? (see page 490)	<polarity> ::= {POSitive NEGative EITHER ALTernate}
:TRIGger[:EDGE]:SOURC e <source> (see page 491)	:TRIGger[:EDGE]:SOURC e? (see page 491)	<source> ::= {CHANnel<n> EXTernal} for DSO models <source> ::= {CHANnel<n> DIGital0,..,DIGital15 EXTernal} for MSO models <n> ::= 1-2 or 1-4 in NR1 format

:TRIGger[:EDGE]:COUPLing

C (see [page 740](#))

Command Syntax :TRIGger[:EDGE]:COUPLing <coupling>
 <coupling> ::= {AC | DC | LFReject}

The :TRIGger[:EDGE]:COUPLing command sets the input coupling for the selected trigger sources. The coupling can be set to AC, DC, or LFReject.

- AC coupling places a high-pass filter (10 Hz for analog channels, and 3.5 Hz for all External trigger inputs) in the trigger path, removing dc offset voltage from the trigger waveform. Use AC coupling to get a stable edge trigger when your waveform has a large dc offset.
- LFReject coupling places a 50 KHz high-pass filter in the trigger path.
- DC coupling allows dc and ac signals into the trigger path.

NOTE

The :TRIGger[:EDGE]:COUPLing and the :TRIGger[:EDGE]:REJect selections are coupled. Changing the setting of the :TRIGger[:EDGE]:REJect can change the COUPLing setting.

Query Syntax :TRIGger[:EDGE]:COUPLing?

The :TRIGger[:EDGE]:COUPLing? query returns the current coupling selection.

Return Format <coupling><NL>
 <coupling> ::= {AC | DC | LFR}

- See Also**
- ["Introduction to :TRIGger Commands"](#) on page 454
 - [":TRIGger:MODE"](#) on page 460
 - [":TRIGger\[:EDGE\]:REJect"](#) on page 489

:TRIGger[:EDGE]:LEVel

C (see [page 740](#))

Command Syntax :TRIGger[:EDGE]:LEVel <level>
 <level> ::= <level>[,<source>]
 <level> ::= 0.75 x full-scale voltage from center screen in NR3 format
 for internal triggers
 <level> ::= ±(external range setting) in NR3 format
 for external triggers
 <level> ::= ±8 V for digital channels (MSO models)
 <source> ::= {CHANnel<n> | EXTernal} for the DSO models
 <source> ::= {CHANnel<n> | DIGital0,...,DIGital15 | EXTernal}
 for the MSO models
 <n> ::= {1 | 2 | 3 | 4} for the four channel oscilloscope models
 <n> ::= {1 | 2} for the two channel oscilloscope models

The :TRIGger[:EDGE]:LEVel command sets the trigger level voltage for the active trigger source.

NOTE

If the optional source is specified and is not the active source, the level on the active source is not affected and the active source is not changed.

Query Syntax :TRIGger[:EDGE]:LEVel? [<source>]

The :TRIGger[:EDGE]:LEVel? query returns the trigger level of the current trigger source.

Return Format <level><NL>

- See Also**
- "Introduction to :TRIGger Commands" on page 454
 - ":TRIGger[:EDGE]:SOURce" on page 491
 - ":EXTernal:RANGe" on page 253
 - ":POD<n>:THReshold" on page 382
 - ":DIGital<n>:THReshold" on page 234

:TRIGger[:EDGE]:REJect

C (see [page 740](#))

Command Syntax :TRIGger[:EDGE]:REJect <reject>
 <reject> ::= {OFF | LFReject | HFReject}

The :TRIGger[:EDGE]:REJect command turns the low-frequency or high-frequency reject filter on or off. You can turn on one of these filters at a time.

- The high frequency reject filter adds a 50 kHz low-pass filter in the trigger path to remove high frequency components from the trigger waveform. Use the high frequency reject filter to remove high-frequency noise, such as AM or FM broadcast stations, from the trigger path.
- The low frequency reject filter adds a 50 kHz high-pass filter in series with the trigger waveform to remove any unwanted low frequency components from a trigger waveform, such as power line frequencies, that can interfere with proper triggering.

NOTE

The :TRIGger[:EDGE]:REJect and the :TRIGger[:EDGE]:COUpling selections are coupled. Changing the setting of the :TRIGger[:EDGE]:COUpling can change the COUpling setting.

Query Syntax :TRIGger[:EDGE]:REJect?

The :TRIGger[:EDGE]:REJect? query returns the current status of the reject filter.

Return Format <reject><NL>
 <reject> ::= {OFF | LFR | HFR}

- See Also**
- "[Introduction to :TRIGger Commands](#)" on page 454
 - "[:TRIGger:HFReject](#)" on page 458
 - "[:TRIGger\[:EDGE\]:COUpling](#)" on page 487

:TRIGger[:EDGE]:SLOPe

C (see [page 740](#))

Command Syntax :TRIGger[:EDGE]:SLOPe <slope>
<slope> ::= {NEGative | POSitive | EITHer | ALTErnate}

The :TRIGger[:EDGE]:SLOPe command specifies the slope of the edge for the trigger. The SLOPe command is not valid in TV trigger mode. Instead, use :TRIGger:TV:POLarity to set the polarity in TV trigger mode.

Query Syntax :TRIGger[:EDGE]:SLOPe?

The :TRIGger[:EDGE]:SLOPe? query returns the current trigger slope.

Return Format <slope><NL>
<slope> ::= {NEG | POS | EITH | ALT}

- See Also**
- "[Introduction to :TRIGger Commands](#)" on page 454
 - "[:TRIGger:MODE](#)" on page 460
 - "[:TRIGger:TV:POLarity](#)" on page 550

Example Code

```
' TRIGGER_EDGE_SLOPE - Sets the slope of the edge for the trigger.  
  
' Set the slope to positive.  
myScope.WriteString ":TRIGGER:EDGE:SLOPE POSITIVE"
```

Example program from the start: "[VISA COM Example in Visual Basic](#)" on page 828

:TRIGger[:EDGE]:SOURce

C (see [page 740](#))

Command Syntax :TRIGger[:EDGE]:SOURce <source>

<source> ::= {CHANnel<n> | EXTernal | LINE} for the DSO models

<source> ::= {CHANnel<n> | DIGital0,...,DIGital15 | EXTernal | LINE}
for the MSO models

<n> ::= {1 | 2 | 3 | 4} for the four channel oscilloscope models

<n> ::= {1 | 2} for the two channel oscilloscope models

The :TRIGger[:EDGE]:SOURce command selects the channel that produces the trigger.

Query Syntax :TRIGger[:EDGE]:SOURce?

The :TRIGger[:EDGE]:SOURce? query returns the current source. If all channels are off, the query returns "NONE."

Return Format <source><NL>

<source> ::= {CHAN<n> | EXT | LINE | NONE} for the DSO models

<source> ::= {CHAN<n> | DIG0,...,DIG15 | EXTernal | LINE | NONE}
for the MSO models

- See Also**
- ["Introduction to :TRIGger Commands"](#) on page 454
 - [":TRIGger:MODE"](#) on page 460

Example Code

```
' TRIGGER_EDGE_SOURCE - Selects the channel that actually produces the
edge trigger. Any channel can be selected.
myScope.WriteString ":TRIGGER:EDGE:SOURCE CHANNEL1"
```

Example program from the start: ["VISA COM Example in Visual Basic"](#) on page 828

:TRIGger:FLEXray Commands

Table 76 :TRIGger:FLEXray Commands Summary

Command	Query	Options and Query Returns
:TRIGger:FLEXray:ERRor:TYPE <error_type> (see page 493)	:TRIGger:FLEXray:ERRor:TYPE? (see page 493)	<error_type> ::= {ALL CODE TSS HCRC FCRC END BOUNDary IDLE SYMbol SLOT NULL SOS FID CCOunt PLENgth}
:TRIGger:FLEXray:FRAMe:CCBase <cycle_count_base> (see page 495)	:TRIGger:FLEXray:FRAMe:CCBase? (see page 495)	<cycle_count_base> ::= integer from 0-63
:TRIGger:FLEXray:FRAMe:CCRepetition <cycle_count_repetition> (see page 496)	:TRIGger:FLEXray:FRAMe:CCRepetition? (see page 496)	<cycle_count_repetition> ::= {ALL <rep #>} <rep #> ::= integer from 2-64
:TRIGger:FLEXray:FRAMe:ID <frame_id> (see page 497)	:TRIGger:FLEXray:FRAMe:ID? (see page 497)	<frame_id> ::= {ALL <frame #>} <frame #> ::= integer from 1-2047
:TRIGger:FLEXray:FRAMe:TYPE <frame_type> (see page 498)	:TRIGger:FLEXray:FRAMe:TYPE? (see page 498)	<frame_type> ::= {NORMAL STARTup NULL SYNC NSTArtup NNULl NSYNc ALL}
:TRIGger:FLEXray:TIME:CBASE <cycle_base> (see page 499)	:TRIGger:FLEXray:TIME:CBASE? (see page 499)	<cycle_base> ::= integer from 0-63
:TRIGger:FLEXray:TIME:CREPpetition <cycle_repetition> (see page 500)	:TRIGger:FLEXray:TIME:CREPpetition? (see page 500)	<cycle_repetition> ::= {ALL <rep #>} <rep #> ::= integer from 2-64
:TRIGger:FLEXray:TIME:SEGMENT <segment_type> (see page 501)	:TRIGger:FLEXray:TIME:SEGMENT? (see page 501)	<segment_type> ::= {STATic DYNamic SYMbol IDLE}
:TRIGger:FLEXray:TIME:SLOT <slot_type>, <slot_id> (see page 502)	:TRIGger:FLEXray:TIME:SLOT? (see page 502)	<slot_type> ::= {ALL EMPTY} <slot_id> ::= {ALL <slot #>} <slot #> ::= integer from 1-2047
:TRIGger:FLEXray:TRIGger <condition> (see page 503)	:TRIGger:FLEXray:TRIGger? (see page 503)	<condition> ::= {FRAME TIME ERRor}

:TRIGger:FLEXray:ERRor:TYPE

N (see page 740)

Command Syntax :TRIGger:FLEXray:ERRor:TYPE <error_type>

```
<error_type> ::= {ALL | CODE | TSS | HCRC | FCRC | END | BOUNDary |
                  IDLE | SYMbol | SLOT | NULL | SOS | FID | CCOunt |
                  PLENgth}
```

Selects the FlexRay error type to trigger on. The error type setting is only valid when the FlexRay trigger mode is set to ERROR.

- ALL – triggers on ALL errors.
- CODE – triggers on only CODE errors (NRZ).
- TSS – triggers on only TSS violations.
- HCRC – triggers on only Header CRC errors.
- FCRC – triggers on only Frame CRC errors.
- END – triggers on only frame END sequence errors.

The following error types are NOT valid when the BUSDoctor is in ASYNchronous mode:

- BOUNDary – triggers on only BOUNDary violations.
- IDLE – triggers only on Network IDLE time violations.
- SYMbol – triggers only on SYMbol window violations.
- SLOT – triggers only on SLOT overbooked errors.
- NULL – triggers only on NULL frame errors.
- SOS – triggers only on Sync Or Startup errors.
- FID – triggers only on Frame ID errors.
- CCOunt – triggers only on Cycle Count errors.
- PLENgth – triggers only on static Payload LENgth errors.

NOTE

This command is only valid when the FLEXray triggering and serial decode option (Option FRS) has been licensed.

Query Syntax :TRIGger:FLEXray:ERRor:TYPE?

The :TRIGger:FLEXray:ERRor:TYPE? query returns the currently selected ified FLEXray error type.

Return Format <error_type><NL>

```
<error_type> ::= {ALL | CODE | TSS | HCRC | FCRC | END | BOUN |
                  IDLE | SYM | SLOT | NULL | SOS | FID | CCO |
                  PLEN}
```

5 Commands by Subsystem

- Errors**
- "-241, Hardware missing" on page 699
- See Also**
- "Introduction to :TRIGger Commands" on page 454
 - ":TRIGger:FLEXray:TRIGger" on page 503

:TRIGger:FLEXray:FRAME:CCBase

N (see [page 740](#))

Command Syntax :TRIGger:FLEXray:FRAME:CCBase <cycle_count_base>
 <cycle_count_base> ::= integer from 0-63

The :TRIGger:FLEXray:FRAME:CCBase command sets the base of the FlexRay cycle count (in the frame header) to trigger on. The cycle count base setting is only valid when the FlexRay trigger mode is set to FRAME.

NOTE

This command is only valid when the FlexRay triggering and serial decode option (Option FRS) has been licensed.

Query Syntax :TRIGger:FLEXray:FRAME:CCBase?

The :TRIGger:FLEXray:FRAME:CCBase? query returns the current cycle count base setting for the FlexRay frame trigger setup.

Return Format <cycle_count_base><NL>
 <cycle_count_base> ::= integer from 0-63

Errors • "-241, Hardware missing" on [page 699](#)

See Also • "Introduction to :TRIGger Commands" on [page 454](#)
 • ":TRIGger:FLEXray:TRIGger" on [page 503](#)

:TRIGger:FLEXray:FRAME:CCRepetition

N (see [page 740](#))

Command Syntax :TRIGger:FLEXray:FRAME:CCRepetition <cycle_count_repetition>
 <cycle_count_repetition> ::= {ALL | <rep #>}
 <rep #> ::= integer from 2-64

The :TRIGger:FLEXray:FRAME:CCRepetition command sets the repetition number of the FlexRay cycle count (in the frame header) to trigger on. The cycle count repetition setting is only valid when the FlexRay trigger mode is set to FRAME.

NOTE

This command is only valid when the FLEXray triggering and serial decode option (Option FRS) has been licensed.

Query Syntax :TRIGger:FLEXray:FRAME:CCRepetition?

The :TRIGger:FLEXray:FRAME:CCRepetition? query returns the current cycle count repetition setting for the FlexRay frame trigger setup.

Return Format <cycle_count_repetition><NL>
 <cycle_count_repetition> ::= {ALL | <rep #>}
 <rep #> ::= integer from 2-64

Errors • "-241, Hardware missing" on [page 699](#)

See Also • "[Introduction to :TRIGger Commands](#)" on [page 454](#)
 • "[:TRIGger:FLEXray:TRIGger](#)" on [page 503](#)

:TRIGger:FLEXray:FRAME:ID

N (see [page 740](#))

Command Syntax :TRIGger:FLEXray:FRAME:ID <frame_id>
 <frame_id> ::= {ALL | <frame #>}
 <frame #> ::= integer from 1-2047

The :TRIGger:FLEXray:FRAME:ID command sets the FlexRay frame ID to trigger on . The frame IF setting is only valid when the FlexRay trigger mode is set to FRAME.

NOTE

This command is only valid when the FLEXray triggering and serial decode option (Option FRS) has been licensed.

Query Syntax :TRIGger:FLEXray:FRAME:ID?

The :TRIGger:FLEXray:FRAME:ID? query returns the current frame ID setting for the FlexRay frame trigger setup.

Return Format <frame_id><NL>
 <frame_id> ::= {ALL | <frame #>}
 <frame #> ::= integer from 1-2047

Errors • "-241, Hardware missing" on [page 699](#)

See Also • ["Introduction to :TRIGger Commands"](#) on [page 454](#)
 • [":TRIGger:MODE"](#) on [page 460](#)
 • [":TRIGger:FLEXray:TRIGger"](#) on [page 503](#)

:TRIGger:FLEXray:FRAME:TYPE

N (see [page 740](#))

Command Syntax :TRIGger:FLEXray:FRAME:TYPE <frame_type>

```
<frame_type> ::= {NORMAL | STARTup | NULL | SYNC | NSTArtup | NNULL |
                  NSYNc | ALL}
```

The :TRIGger:FLEXray:FRAME:TYPE command sets the FlexRay frame type to trigger on. The frame type setting is only valid when the FlexRay trigger mode is set to FRAME.

- **NORMAL** – will trigger on only normal (NSTArtup & NNULL & NSYNc) frames.
- **STARTup** – will trigger on only startup frames.
- **NULL** – will trigger on only null frames.
- **SYNC** – will trigger on only sync frames.
- **NSTArtup** – will trigger on frames other than startup frames.
- **NNULL** – will trigger on frames other than null frames.
- **NSYNc** – will trigger on frames other than sync frames.
- **ALL** – will trigger on all FlexRay frame types.

NOTE

This command is only valid when the FLEXray triggering and serial decode option (Option FRS) has been licensed.

Query Syntax :TRIGger:FLEXray:FRAME:TYPE?

The :TRIGger:FLEXray:FRAME:TYPE? query returns the current frame type setting for the FlexRay frame trigger setup.

Return Format <frame_type><NL>

```
<frame_type> ::= {NORM | STAR | NULL | SYNC | NSTA | NNUL |
                  NSYN | ALL}
```

- See Also**
- ["Introduction to :TRIGger Commands"](#) on page 454
 - [":TRIGger:MODE"](#) on page 460
 - [":TRIGger:FLEXray:TRIGger"](#) on page 503

:TRIGger:FLEXray:TIME:CBASe

N (see [page 740](#))

Command Syntax :TRIGger:FLEXray:TIME:CBASe <cycle_base>
 <cycle_base> ::= integer from 0-63

The :TRIGger:FLEXray:TIME:CBASe command sets the base of the FlexRay cycle to trigger on. The cycle base setting is only valid when the FlexRay trigger mode is set to TIME.

NOTE

This command is only valid when the FLEXray triggering and serial decode option (Option FRS) has been licensed.

Query Syntax :TRIGger:FLEXray:TIME:CBASe?

The :TRIGger:FLEXray:TIME:CBASe? query returns the current cycle base setting for the FlexRay time trigger setup.

Return Format <cycle_base><NL>

<cycle_base> ::= integer from 0-63

- See Also**
- ["Introduction to :TRIGger Commands"](#) on page 454
 - [":TRIGger:MODE"](#) on page 460
 - [":TRIGger:FLEXray:TRIGger"](#) on page 503

:TRIGger:FLEXray:TIME:CREPetition

N (see [page 740](#))

Command Syntax :TRIGger:FLEXray:TIME:CREPetition <cycle_repetition>
 <cycle_repetition> ::= {ALL | <rep #>}
 <rep #> ::= integer from 2-64

The :TRIGger:FLEXray:TIME:CREPetition command sets the repetition number of the FlexRay cycle to trigger on. The cycle repetition setting is only valid when the FlexRay trigger mode is set to TIME.

NOTE

This command is only valid when the FLEXray triggering and serial decode option (Option FRS) has been licensed.

Query Syntax :TRIGger:FLEXray:TIME:CREPetition?

The :TRIGger:FLEXray:TIME:CREPetition? query returns the current cycle repetition setting for the FlexRay time trigger setup.

Return Format <cycle_repetition><NL>
 <cycle_repetition> ::= {ALL | <rep #>}
 <rep #> ::= integer from 2-64

- See Also**
- "Introduction to :TRIGger Commands" on page 454
 - ":TRIGger:MODE" on page 460
 - ":TRIGger:FLEXray:TRIGger" on page 503

:TRIGger:FLEXray:TIME:SEGment

N (see [page 740](#))

Command Syntax :TRIGger:FLEXray:TIME:SEGment <segment_type>
 <segment_type> ::= {STATIC | DYNamic | SYMbol | IDLE}

The :TRIGger:FLEXray:TIME:SEGment command sets the FlexRay segment type. The segment setting is only valid when the FlexRay trigger mode is set to TIME.

NOTE

This command is only valid when the FLEXray triggering and serial decode option (Option FRS) has been licensed.

Query Syntax :TRIGger:FLEXray:TIME:SEGment?

The :TRIGger:FLEXray:TIME:SEGment? query returns the current segment setting for the FlexRay time trigger setup.

Return Format <segment_type><NL>
 <segment_type> ::= {STAT | DYN | SYM | IDLE}

- See Also**
- ["Introduction to :TRIGger Commands"](#) on page 454
 - [":TRIGger:MODE"](#) on page 460
 - [":TRIGger:FLEXray:TRIGger"](#) on page 503

:TRIGger:FLEXray:TIME:SLOT

N (see [page 740](#))

Command Syntax :TRIGger:FLEXray:TIME:SLOT <slot_type>, <slot_id>
 <slot_type> ::= {ALL | EMPTY}
 <slot_id> ::= {ALL | <slot #>}
 <slot #> ::= integer from 1-2047

The :TRIGger:FLEXray:TIME:SLOT command sets the FlexRay slot type and ID. The slot setting is only valid when the FlexRay trigger mode is set to TIME.

NOTE

This command is only valid when the FLEXray triggering and serial decode option (Option FRS) has been licensed.

Query Syntax :TRIGger:FLEXray:TIME:SLOT?

The :TRIGger:FLEXray:TIME:SLOT? query returns the current source for the FLEXray signal.

Return Format <slot_type>, <slot_id><NL>
 <slot_type> ::= {ALL | EMPTY}
 <slot_id> ::= {ALL | <slot #>}
 <slot #> ::= integer from 1-2047

- See Also**
- ["Introduction to :TRIGger Commands"](#) on page 454
 - [":TRIGger:MODE"](#) on page 460
 - [":TRIGger:FLEXray:TRIGger"](#) on page 503

:TRIGger:FLEXray:TRIGger

N (see [page 740](#))

Command Syntax :TRIGger:FLEXray:TRIGger <condition>
 <condition> ::= {FRAMe | TIME | ERRor}

The :TRIGger:FLEXray:TRIGger command sets the FLEXray trigger on condition:

- FRAME – triggers on specified frames (without errors).
- TIME – triggers on specified bus cycles, segments, and slots.
- ERRor – triggers on selected active error frames and unknown bus conditions.

NOTE

This command is only valid when the FLEXray triggering and serial decode option (Option FRS) has been licensed.

Query Syntax :TRIGger:FLEXray:TRIGger?

The :TRIGger:FLEXray:TRIGger? query returns the current FLEXray trigger on condition.

Return Format <condition><NL>
 <condition> ::= {FRAM | TIME | ERR}

Errors • "-241, Hardware missing" on [page 699](#)

- See Also**
- "Introduction to :TRIGger Commands" on [page 454](#)
 - ":TRIGger:MODE" on [page 460](#)
 - ":TRIGger:FLEXray:ERRor:TYPE" on [page 493](#)
 - ":TRIGger:FLEXray:FRAMe:CCBase" on [page 495](#)
 - ":TRIGger:FLEXray:FRAMe:CCRepetition" on [page 496](#)
 - ":TRIGger:FLEXray:FRAMe:ID" on [page 497](#)
 - ":TRIGger:FLEXray:FRAMe:TYPE" on [page 498](#)
 - ":TRIGger:FLEXray:TIME:CBase" on [page 499](#)
 - ":TRIGger:FLEXray:TIME:CREpetition" on [page 500](#)
 - ":TRIGger:FLEXray:TIME:SEGment" on [page 501](#)
 - ":TRIGger:FLEXray:TIME:SLOT" on [page 502](#)

:TRIGger:GLITch Commands

Table 77 :TRIGger:GLITch Commands Summary

Command	Query	Options and Query Returns
:TRIGger:GLITch:GREAt erthan <greater_than_time>[s uffix] (see page 506)	:TRIGger:GLITch:GREAt erthan? (see page 506)	<greater_than_time> ::= floating-point number in NR3 format [suffix] ::= {s ms us ns ps}
:TRIGger:GLITch:LESSt han <less_than_time>[suff ix] (see page 507)	:TRIGger:GLITch:LESSt han? (see page 507)	<less_than_time> ::= floating-point number in NR3 format [suffix] ::= {s ms us ns ps}
:TRIGger:GLITch:LEVel <level> [<source>] (see page 508)	:TRIGger:GLITch:LEVel ? (see page 508)	For internal triggers, <level> ::= .75 x full-scale voltage from center screen in NR3 format. For external triggers (DSO models), <level> ::= ±(external range setting) in NR3 format. For digital channels (MSO models), <level> ::= ±8 V. <source> ::= {CHANnel<n> EXTernal} for DSO models <source> ::= {CHANnel<n> DIGital0,...,DIGital15} for MSO models <n> ::= 1-2 or 1-4 in NR1 format
:TRIGger:GLITch:POLAr ity <polarity> (see page 509)	:TRIGger:GLITch:POLAr ity? (see page 509)	<polarity> ::= {POSitive NEGative}
:TRIGger:GLITch:QUALi fier <qualifier> (see page 510)	:TRIGger:GLITch:QUALi fier? (see page 510)	<qualifier> ::= {GREATERthan LESSthan RANGE}

Table 77 :TRIGger:GLITch Commands Summary (continued)

Command	Query	Options and Query Returns
:TRIGger:GLITch:RANGe <less_than_time>[suffix], <greater_than_time>[suffix] (see page 511)	:TRIGger:GLITch:RANGe? (see page 511)	<less_than_time> ::= 15 ns to 10 seconds in NR3 format <greater_than_time> ::= 10 ns to 9.99 seconds in NR3 format [suffix] ::= {s ms us ns ps}
:TRIGger:GLITch:SOURce <source> (see page 512)	:TRIGger:GLITch:SOURce? (see page 512)	<source> ::= {CHANnel<n> EXTERNAL} for DSO models <source> ::= {CHANnel<n> DIGital0,...,DIGital15 } for MSO models <n> ::= 1-2 or 1-4 in NR1 format

:TRIGger:GLITch:GREaterthan

N (see [page 740](#))

Command Syntax :TRIGger:GLITch:GREaterthan <greater_than_time>[<suffix>]
<greater_than_time> ::= floating-point number in NR3 format
<suffix> ::= {s | ms | us | ns | ps}

The :TRIGger:GLITch:GREaterthan command sets the minimum pulse width duration for the selected :TRIGger:GLITch:SOURce.

Query Syntax :TRIGger:GLITch:GREaterthan?

The :TRIGger:GLITch:GREaterthan? query returns the minimum pulse width duration time for :TRIGger:GLITch:SOURce.

Return Format <greater_than_time><NL>
<greater_than_time> ::= floating-point number in NR3 format.

- See Also**
- ["Introduction to :TRIGger Commands"](#) on page 454
 - [":TRIGger:GLITch:SOURce"](#) on page 512
 - [":TRIGger:GLITch:QUALifier"](#) on page 510
 - [":TRIGger:MODE"](#) on page 460

:TRIGger:GLITch:LESSthan

N (see [page 740](#))

Command Syntax :TRIGger:GLITch:LESSthan <less_than_time>[<suffix>]
 <less_than_time> ::= floating-point number in NR3 format
 <suffix> ::= {s | ms | us | ns | ps}

The :TRIGger:GLITch:LESSthan command sets the maximum pulse width duration for the selected :TRIGger:GLITch:SOURce.

Query Syntax :TRIGger:GLITch:LESSthan?

The :TRIGger:GLITch:LESSthan? query returns the pulse width duration time for :TRIGger:GLITch:SOURce.

Return Format <less_than_time><NL>
 <less_than_time> ::= floating-point number in NR3 format.

- See Also**
- ["Introduction to :TRIGger Commands"](#) on page 454
 - [":TRIGger:GLITch:SOURce"](#) on page 512
 - [":TRIGger:GLITch:QUALifier"](#) on page 510
 - [":TRIGger:MODE"](#) on page 460

:TRIGger:GLITch:LEVel

N (see [page 740](#))

Command Syntax :TRIGger:GLITch:LEVel <level_argument>
 <level_argument> ::= <level>[, <source>]
 <level> ::= .75 x full-scale voltage from center screen in NR3 format
 for internal triggers
 <level> ::= ±(external range setting) in NR3 format
 for external triggers (DSO models)
 <level> ::= ±8 V for digital channels (MSO models)
 <source> ::= {CHANnel<n> | EXTernal} for DSO models
 <source> ::= {CHANnel<n> | DIGital0,..,DIGital15} for MSO models
 <n> ::= {1 | 2 | 3 | 4} for the four channel oscilloscope models
 <n> ::= {1 | 2} for the two channel oscilloscope models

The :TRIGger:GLITch:LEVel command sets the trigger level voltage for the active pulse width trigger.

Query Syntax :TRIGger:GLITch:LEVel?

The :TRIGger:GLITch:LEVel? query returns the trigger level of the current pulse width trigger mode. If all channels are off, the query returns "NONE."

Return Format <level_argument><NL>

- See Also**
- ["Introduction to :TRIGger Commands"](#) on page 454
 - [":TRIGger:MODE"](#) on page 460
 - [":TRIGger:GLITch:SOURce"](#) on page 512
 - [":EXTernal:RANGe"](#) on page 253

:TRIGger:GLITch:POLarity

N (see [page 740](#))

Command Syntax :TRIGger:GLITch:POLarity <polarity>
 <polarity> ::= {POSitive | NEGative}

The :TRIGger:GLITch:POLarity command sets the polarity for the glitch pulse width trigger.

Query Syntax :TRIGger:GLITch:POLarity?

The :TRIGger:GLITch:POLarity? query returns the glitch pulse width trigger polarity.

Return Format <polarity><NL>
 <polarity> ::= {POS | NEG}

- See Also**
- "[Introduction to :TRIGger Commands](#)" on page 454
 - "[:TRIGger:MODE](#)" on page 460
 - "[:TRIGger:GLITch:SOURce](#)" on page 512

:TRIGger:GLITCh:QUALifier

N (see [page 740](#))

Command Syntax :TRIGger:GLITCh:QUALifier <operator>
<operator> ::= {GREATERthan | LESSthan | RANGE}

This command sets the mode of operation of the glitch pulse width trigger. The oscilloscope can trigger on a pulse width that is greater than a time value, less than a time value, or within a range of time values.

Query Syntax :TRIGger:GLITCh:QUALifier?

The :TRIGger:GLITCh:QUALifier? query returns the glitch pulse width qualifier.

Return Format <operator><NL>
<operator> ::= {GRE | LESS | RANG}

- See Also**
- "[Introduction to :TRIGger Commands](#)" on page 454
 - "[:TRIGger:GLITCh:SOURce](#)" on page 512
 - "[:TRIGger:MODE](#)" on page 460

:TRIGger:GLITch:RANGe

N (see [page 740](#))

Command Syntax :TRIGger:GLITch:RANGe <less_than_time>[suffix],
<greater_than_time>[suffix]

<less_than_time> ::= (15 ns - 10 seconds) in NR3 format
<greater_than_time> ::= (10 ns - 9.99 seconds) in NR3 format
[suffix] ::= {s | ms | us | ns | ps}

The :TRIGger:GLITch:RANGe command sets the pulse width duration for the selected :TRIGger:GLITch:SOURce. You can enter the parameters in any order – the smaller value becomes the <greater_than_time> and the larger value becomes the <less_than_time>.

Query Syntax :TRIGger:GLITch:RANGe?

The :TRIGger:GLITch:RANGe? query returns the pulse width duration time for :TRIGger:GLITch:SOURce.

Return Format <less_than_time>,<greater_than_time><NL>

- See Also**
- ["Introduction to :TRIGger Commands"](#) on page 454
 - [":TRIGger:GLITch:SOURce"](#) on page 512
 - [":TRIGger:GLITch:QUALifier"](#) on page 510
 - [":TRIGger:MODE"](#) on page 460

:TRIGger:GLITch:SOURce

N (see [page 740](#))

Command Syntax :TRIGger:GLITch:SOURce <source>

<source> ::= {CHANnel<n> | EXTernal} for the DSO models

<source> ::= {DIGital0,...,DIGital15 | CHANnel<n>} for the MSO models

<n> ::= {1 | 2 | 3 | 4} for the four channel oscilloscope models

<n> ::= {1 | 2} for the two channel oscilloscope models

The :TRIGger:GLITch:SOURce command selects the channel that produces the pulse width trigger.

Query Syntax :TRIGger:GLITch:SOURce?

The :TRIGger:GLITch:SOURce? query returns the current pulse width source. If all channels are off, the query returns "NONE."

Return Format <source><NL>

- See Also**
- ["Introduction to :TRIGger Commands"](#) on page 454
 - [":TRIGger:MODE"](#) on page 460
 - [":TRIGger:GLITch:LEVel"](#) on page 508
 - [":TRIGger:GLITch:POLarity"](#) on page 509
 - [":TRIGger:GLITch:QUALifier"](#) on page 510
 - [":TRIGger:GLITch:RANGe"](#) on page 511

Example Code • ["Example Code"](#) on page 491

:TRIGger:IIC Commands

Table 78 :TRIGger:IIC Commands Summary

Command	Query	Options and Query Returns
:TRIGger:IIC:PATtern:ADDRESS <value> (see page 514)	:TRIGger:IIC:PATtern:ADDRESS? (see page 514)	<value> ::= integer or <string> <string> ::= "0xnn" n ::= {0,...,9 A,...,F}
:TRIGger:IIC:PATtern:DATA <value> (see page 515)	:TRIGger:IIC:PATtern:DATA? (see page 515)	<value> ::= integer or <string> <string> ::= "0xnn" n ::= {0,...,9 A,...,F}
:TRIGger:IIC:PATtern:DATA2 <value> (see page 516)	:TRIGger:IIC:PATtern:DATA2? (see page 516)	<value> ::= integer or <string> <string> ::= "0xnn" n ::= {0,...,9 A,...,F}
:TRIGger:IIC[:SOURce]:CLOCK <source> (see page 517)	:TRIGger:IIC[:SOURce]:CLOCK? (see page 517)	<source> ::= {CHANnel<n> EXTErnal} for DSO models <source> ::= {CHANnel<n> DIGital0,...,DIGital15 } for MSO models <n> ::= 1-2 or 1-4 in NR1 format
:TRIGger:IIC[:SOURce]:DATA <source> (see page 518)	:TRIGger:IIC[:SOURce]:DATA? (see page 518)	<source> ::= {CHANnel<n> EXTErnal} for DSO models <source> ::= {CHANnel<n> DIGital0,...,DIGital15 } for MSO models <n> ::= 1-2 or 1-4 in NR1 format
:TRIGger:IIC:TRIGger:QUALifier <value> (see page 519)	:TRIGger:IIC:TRIGger:QUALifier? (see page 519)	<value> ::= {EQUal NOTequal LESSthan GREATERthan}
:TRIGger:IIC:TRIGger[:TYPE] <type> (see page 520)	:TRIGger:IIC:TRIGger[:TYPE]? (see page 520)	<type> ::= {START STOP READ7 READEprom WRITe7 WRITe10 NACKnowledge ANACKnowledge R7Data2 W7Data2 REStart}

:TRIGger:IIC:PATtern:ADDRess

N (see [page 740](#))

Command Syntax :TRIGger:IIC:PATtern:ADDRess <value>

<value> ::= integer or <string>

<string> ::= "0xnn" where n ::= {0,...,9 | A,...,F}

The :TRIGger:IIC:PATtern:ADDRess command sets the address for IIC data. The address can range from 0x00 to 0x7F (7-bit) or 0x3FF (10-bit) hexadecimal. Use the don't care address (-1 or 0xFFFFFFFF) to ignore the address value.

Query Syntax :TRIGger:IIC:PATtern:ADDRess?

The :TRIGger:IIC:PATtern:ADDRess? query returns the current address for IIC data.

Return Format <value><NL>

<value> ::= integer

- See Also**
- ["Introduction to :TRIGger Commands"](#) on page 454
 - [":TRIGger:IIC:PATtern:DATA"](#) on page 515
 - [":TRIGger:IIC:PATtern:DATA2"](#) on page 516
 - [":TRIGger:IIC:TRIGger\[:TYPE\]"](#) on page 520

:TRIGger:IIC:PATtern:DATA

N (see [page 740](#))

Command Syntax :TRIGger:IIC:PATtern:DATA <value>

<value> ::= integer or <string>

<string> ::= "0xnn" where n ::= {0,...,9 | A,...,F}

The :TRIGger:IIC:PATtern:DATA command sets IIC data. The data value can range from 0x00 to 0x0FF (hexadecimal). Use the don't care data pattern (-1 or 0xFFFFFFFF) to ignore the data value.

Query Syntax :TRIGger:IIC:PATtern:DATA?

The :TRIGger:IIC:PATtern:DATA? query returns the current pattern for IIC data.

Return Format <value><NL>

- See Also**
- ["Introduction to :TRIGger Commands"](#) on page 454
 - [":TRIGger:IIC:PATtern:ADDRess"](#) on page 514
 - [":TRIGger:IIC:PATtern:DATA2"](#) on page 516
 - [":TRIGger:IIC:TRIGger\[:TYPE\]"](#) on page 520

:TRIGger:IIC:PATtern:DATA2

N (see [page 740](#))

Command Syntax :TRIGger:IIC:PATtern:DATA2 <value>

<value> ::= integer or <string>

<string> ::= "0xnn" where n ::= {0,...,9 | A,...,F}

The :TRIGger:IIC:PATtern:DATA2 command sets IIC data 2. The data value can range from 0x00 to 0x0FF (hexadecimal). Use the don't care data pattern (-1 or 0xFFFFFFFF) to ignore the data value.

Query Syntax :TRIGger:IIC:PATtern:DATA2?

The :TRIGger:IIC:PATtern:DATA2? query returns the current pattern for IIC data 2.

Return Format <value><NL>

- See Also**
- ["Introduction to :TRIGger Commands"](#) on page 454
 - [":TRIGger:IIC:PATtern:ADDRESS"](#) on page 514
 - [":TRIGger:IIC:PATtern:DATA"](#) on page 515
 - [":TRIGger:IIC:TRIGger\[:TYPE\]"](#) on page 520

:TRIGger:IIC[:SOURce]:CLOCK

N (see [page 740](#))

Command Syntax :TRIGger:IIC:[SOURce:]CLOCK <source>

<source> ::= {CHANnel<n> | EXTernal} for the DSO models

<source> ::= {CHANnel<n> | DIGital0,..,DIGital15} for the MSO models

<n> ::= {1 | 2 | 3 | 4} for the four channel oscilloscope models

<n> ::= {1 | 2} for the two channel oscilloscope models

The :TRIGger:IIC:[SOURce:]CLOCK command sets the source for the IIC serial clock (SCL).

Query Syntax :TRIGger:IIC:[SOURce:]CLOCK?

The :TRIGger:IIC:[SOURce:]CLOCK? query returns the current source for the IIC serial clock.

Return Format <source><NL>

- See Also**
- ["Introduction to :TRIGger Commands"](#) on page 454
 - [":TRIGger:IIC\[:SOURce\]:DATA"](#) on page 518

:TRIGger:IIC[:SOURce]:DATA

N (see [page 740](#))

Command Syntax :TRIGger:IIC:[SOURce:]DATA <source>

<source> ::= {CHANnel<n> | EXTernal} for the DSO models

<source> ::= {CHANnel<n> | DIGital0,..,DIGital15} for the MSO models

<n> ::= {1 | 2 | 3 | 4} for the four channel oscilloscope models

<n> ::= {1 | 2} for the two channel oscilloscope models

The :TRIGger:IIC:[SOURce:]DATA command sets the source for IIC serial data (SDA).

Query Syntax :TRIGger:IIC:[SOURce:]DATA?

The :TRIGger:IIC:[SOURce:]DATA? query returns the current source for IIC serial data.

Return Format <source><NL>

- See Also**
- ["Introduction to :TRIGger Commands"](#) on page 454
 - [":TRIGger:IIC\[:SOURce\]:CLOCK"](#) on page 517

:TRIGger:IIC:TRIGger:QUALifier

N (see [page 740](#))

Command Syntax :TRIGger:IIC:TRIGger:QUALifier <value>
 <value> ::= {EQUAL | NOTequal | LESSthan | GREATERthan}

The :TRIGger:IIC:TRIGger:QUALifier command sets the IIC data qualifier when TRIGger:IIC:TRIGger[:TYPE] is set to READEprom.

Query Syntax :TRIGger:IIC:TRIGger:QUALifier?

The :TRIGger:IIC:TRIGger:QUALifier? query returns the current IIC data qualifier value.

Return Format <value><NL>
 <value> ::= {EQUAL | NOTequal | LESSthan | GREATERthan}

- See Also**
- "[Introduction to :TRIGger Commands](#)" on page 454
 - "[:TRIGger:MODE](#)" on page 460
 - "[:TRIGger:IIC:TRIGger\[:TYPE\]](#)" on page 520

:TRIGger:IIC:TRIGger[:TYPE]

N (see [page 740](#))

Command Syntax :TRIGger:IIC:TRIGger[:TYPE] <value>

<value> ::= {START | STOP | READ7 | READEprom | WRITe7 | WRITe10
| NACKnowledge | ANACKnowledge | R7Data2 | W7Data2 | REStart}

The :TRIGger:IIC:TRIGger[:TYPE] command sets the IIC trigger type:

- START – Start condition.
- STOP – Stop condition.
- READ7 – 7-bit address frame containing (Start:Address7:Read:Ack:Data). The value READ is also accepted for READ7.
- R7Data2 – 7-bit address frame containing (Start:Address7:Read:Ack:Data:Ack:Data2).
- READEprom – EEPROM data read.
- WRITe7 – 7-bit address frame containing (Start:Address7:Write:Ack:Data). The value WRITE is also accepted for WRITe7.
- W7Data2 – 7-bit address frame containing (Start:Address7:Write:Ack:Data:Ack:Data2).
- WRITe10 – 10-bit address frame containing (Start:Address byte1:Write:Ack:Address byte 2:Data).
- NACKnowledge – Missing acknowledge.
- ANACKnowledge – Address with no acknowledge.
- REStart – Another start condition occurs before a stop condition.

NOTE

The short form of READ7 (READ7), READEprom (READE), WRITe7 (WRIT7), and WRITe10 (WRIT10) do not follow the defined Long Form to Short Form Truncation Rules (see [page 742](#)).

Query Syntax :TRIGger:IIC:TRIGger[:TYPE]?

The :TRIGger:IIC:TRIGger[:TYPE]? query returns the current IIC trigger type value.

Return Format <value><NL>

<value> ::= {STAR | STOP | READ7 | READE | WRIT7 | WRIT10 | NACK | ANAC
| R7D2 | W7D2 | REST}

- See Also**
- "[Introduction to :TRIGger Commands](#)" on page 454
 - "[:TRIGger:MODE](#)" on page 460

- ":TRIGger:IIC:PATtern:ADDRes" on page 514
- ":TRIGger:IIC:PATtern:DATA" on page 515
- ":TRIGger:IIC:PATtern:DATA2" on page 516
- ":TRIGger:IIC:TRIGger:QUALifier" on page 519
- "Long Form to Short Form Truncation Rules" on page 742

:TRIGger:LIN Commands

Table 79 :TRIGger:LIN Commands Summary

Command	Query	Options and Query Returns
:TRIGger:LIN:ID <value> (see page 523)	:TRIGger:LIN:ID? (see page 523)	<value> ::= 7-bit integer in decimal, <nondecimal>, or <string> from 0-63 or 0x00-0x3f (with Option AMS) <nondecimal> ::= #Hnn where n ::= {0,...,9 A,...,F} for hexadecimal <nondecimal> ::= #Bnn...n where n ::= {0 1} for binary <string> ::= "0xnn" where n ::= {0,...,9 A,...,F} for hexadecimal
:TRIGger:LIN:SAMplepo int <value> (see page 524)	:TRIGger:LIN:SAMplepo int? (see page 524)	<value> ::= {60 62.5 68 70 75 80 87.5} in NR3 format
:TRIGger:LIN:SIGNAL:B AUDrate <baudrate> (see page 525)	:TRIGger:LIN:SIGNAL:B AUDrate? (see page 525)	<baudrate> ::= integer from 2400 to 625000 in 100 b/s increments
:TRIGger:LIN:SOURce <source> (see page 526)	:TRIGger:LIN:SOURce? (see page 526)	<source> ::= {CHANnel<n> EXTernal} for DSO models <source> ::= {CHANnel<n> DIGital0,...,DIGital15} for MSO models <n> ::= 1-2 or 1-4 in NR1 format
:TRIGger:LIN:STANdard <std> (see page 527)	:TRIGger:LIN:STANdard ? (see page 527)	<std> ::= {LIN13 LIN20}
:TRIGger:LIN:SYNCbrea k <value> (see page 528)	:TRIGger:LIN:SYNCbrea k? (see page 528)	<value> ::= integer = {11 12 13}
:TRIGger:LIN:TRIGger <condition> (see page 529)	:TRIGger:LIN:TRIGger? (see page 529)	<condition> ::= {SYNCbreak} (without Option AMS) <condition> ::= {SYNCbreak ID} (with Option AMS)

:TRIGger:LIN:ID

N (see [page 740](#))

Command Syntax :TRIGger:LIN:ID <value>

<value> ::= 7-bit integer in decimal, <nondecimal>, or <string>
from 0-63 or 0x00-0x3f

<nondecimal> ::= #Hnn where n ::= {0,...,9 | A,...,F} for hexadecimal

<nondecimal> ::= #Bnn...n where n ::= {0 | 1} for binary

<string> ::= "0xn" where n ::= {0,...,9 | A,...,F} for hexadecimal

The :TRIGger:LIN:ID command defines the LIN identifier searched for in each CAN message when the LIN trigger mode is set to frame ID.

NOTE

This command is only valid when the automotive CAN and LIN serial decode option (Option AMS) has been licensed.

Setting the ID to a value of "-1" results in "0xXX" which is equivalent to all IDs.

Query Syntax :TRIGger:LIN:ID?

The :TRIGger:LIN:ID? query returns the current LIN identifier setting.

Return Format <value><NL>

<value> ::= integer in decimal

Errors • ["-241, Hardware missing"](#) on page 699

See Also • ["Introduction to :TRIGger Commands"](#) on page 454
• [":TRIGger:MODE"](#) on page 460
• [":TRIGger:LIN:TRIGger"](#) on page 529
• [":TRIGger:LIN:SIGNAL:DEFinition"](#) on page 693
• [":TRIGger:LIN:SOURce"](#) on page 526

:TRIGger:LIN:SAMPlEpoint

N (see [page 740](#))

Command Syntax :TRIGger:LIN:SAMPlEpoint <value>
<value><NL>

<value> ::= {60 | 62.5 | 68 | 70 | 75 | 80 | 87.5} in NR3 format

The :TRIGger:LIN:SAMPlEpoint command sets the point during the bit time where the bit level is sampled to determine whether the bit is dominant or recessive. The sample point represents the percentage of time between the beginning of the bit time to the end of the bit time.

NOTE

The sample point values are not limited by the baud rate.

Query Syntax :TRIGger:LIN:SAMPlEpoint?

The :TRIGger:LIN:SAMPlEpoint? query returns the current LIN sample point setting.

Return Format <value><NL>

<value> ::= {60 | 62.5 | 68 | 70 | 75 | 80 | 87.5} in NR3 format

- See Also**
- "[Introduction to :TRIGger Commands](#)" on page 454
 - "[:TRIGger:MODE](#)" on page 460
 - "[:TRIGger:LIN:TRIGger](#)" on page 529

:TRIGger:LIN:SIGNal:BAUDrate

N (see [page 740](#))

Command Syntax :TRIGger:LIN:SIGNal:BAUDrate <baudrate>

<baudrate> ::= integer from 2400 to 625000 in 100 b/s increments

The :TRIGger:LIN:SIGNal:BAUDrate command sets the standard baud rate of the LIN signal from 2400 b/s to 625 kb/s in 100 b/s increments. If you enter a baud rate that is not divisible by 100 b/s, the baud rate is set to the nearest baud rate divisible by 100 b/s.

Query Syntax :TRIGger:LIN:SIGNal:BAUDrate?

The :TRIGger:LIN:SIGNal:BAUDrate? query returns the current LIN baud rate setting.

Return Format <baudrate><NL>

<baudrate> ::= integer from 2400 to 625000 in 100 b/s increments

- See Also**
- ["Introduction to :TRIGger Commands"](#) on page 454
 - [":TRIGger:MODE"](#) on page 460
 - [":TRIGger:LIN:TRIGger"](#) on page 529
 - [":TRIGger:LIN:SIGNal:DEFinition"](#) on page 693
 - [":TRIGger:LIN:SOURce"](#) on page 526

:TRIGger:LIN:SOURce

N (see [page 740](#))

Command Syntax :TRIGger:LIN:SOURce <source>

<source> ::= {CHANnel<n> | EXTernal} for the DSO models

<source> ::= {CHANnel<n> | DIGital0,...,DIGital15} for the MSO models

<n> ::= {1 | 2 | 3 | 4} for the four channel oscilloscope models

<n> ::= {1 | 2} for the two channel oscilloscope models

The :TRIGger:LIN:SOURce command sets the source for the LIN signal.

Query Syntax :TRIGger:LIN:SOURce?

The :TRIGger:LIN:SOURce? query returns the current source for the LIN signal.

Return Format <source><NL>

- See Also**
- ["Introduction to :TRIGger Commands"](#) on page 454
 - [":TRIGger:MODE"](#) on page 460
 - [":TRIGger:LIN:TRIGger"](#) on page 529
 - [":TRIGger:LIN:SIGNAL:DEFinition"](#) on page 693

:TRIGger:LIN:STANdard

N (see [page 740](#))

Command Syntax :TRIGger:LIN:STANdard <std>
 <std> ::= {LIN13 | LIN20}

The :TRIGger:LIN:STANdard command sets the LIN standard in effect for triggering and decoding to be LIN1.3 or LIN2.0.

Query Syntax :TRIGger:LIN:STANdard?

The :TRIGger:LIN:STANdard? query returns the current LIN standard setting.

Return Format <std><NL>
 <std> ::= {LIN13 | LIN20}

- See Also**
- "[Introduction to :TRIGger Commands](#)" on page 454
 - "[:TRIGger:MODE](#)" on page 460
 - "[:TRIGger:LIN:SIGNAL:DEFinition](#)" on page 693
 - "[:TRIGger:LIN:SOURce](#)" on page 526

:TRIGger:LIN:SYNCbreak

N (see [page 740](#))

Command Syntax :TRIGger:LIN:SYNCbreak <value>
<value> ::= integer = {11 | 12 | 13}

The :TRIGger:LIN:SYNCbreak command sets the length of the LIN sync break to be greater than or equal to 11, 12, or 13 clock lengths. The sync break is the idle period in the bus activity at the beginning of each packet that distinguishes one information packet from the previous one.

Query Syntax :TRIGger:LIN:SYNCbreak?

The :TRIGger:LIN:STANdard? query returns the current LIN sync break setting.

Return Format <value><NL>
<value> ::= {11 | 12 | 13}

- See Also**
- "[Introduction to :TRIGger Commands](#)" on page 454
 - "[:TRIGger:MODE](#)" on page 460
 - "[:TRIGger:LIN:SIGNal:DEFinition](#)" on page 693
 - "[:TRIGger:LIN:SOURce](#)" on page 526

:TRIGger:LIN:TRIGger

N (see [page 740](#))

Command Syntax :TRIGger:LIN:TRIGger <condition>
 <condition> ::= {SYNCbreak | ID}

The :TRIGger:LIN:TRIGger command sets the LIN trigger on condition to be Sync Break (SYNCbreak) or Frame Id (ID).

NOTE

The ID option is available when the automotive CAN and LIN serial decode option (Option AMS) has been licensed.

Query Syntax :TRIGger:LIN:TRIGger?

The :TRIGger:LIN:TRIGger? query returns the current LIN trigger value.

Return Format <condition><NL>
 <condition> ::= {SYNC | ID}

Errors • ["-241, Hardware missing"](#) on page 699

See Also • ["Introduction to :TRIGger Commands"](#) on page 454
 • [":TRIGger:MODE"](#) on page 460
 • [":TRIGger:LIN:SIGNAL:DEFinition"](#) on page 693
 • [":TRIGger:LIN:SOURce"](#) on page 526

:TRIGger:SEQuence Commands

Table 80 :TRIGger:SEQuence Commands Summary

Command	Query	Options and Query Returns
:TRIGger:SEQuence:COU Nt <count> (see page 531)	:TRIGger:SEQuence:COU Nt? (see page 531)	<count> ::= integer in NR1 format
:TRIGger:SEQuence:EDG E{1 2} <source>, <slope> (see page 532)	:TRIGger:SEQuence:EDG E{1 2}? (see page 532)	<source> ::= {CHANnel<n> EXTernal} for the DSO models <source> ::= {CHANnel<n> DIGital0,...,DIGital15} for the MSO models <slope> ::= {POSitive NEGative} <n> ::= 1-2 or 1-4 in NR1 format <return_value> ::= query returns "NONE" if edge source is disabled
:TRIGger:SEQuence:FIN D <value> (see page 533)	:TRIGger:SEQuence:FIN D? (see page 533)	<value> ::= {PATtern1,ENTERed PATtern1,EXITed EDGE1 PATtern1,AND,EDGE1}
:TRIGger:SEQuence:PAT Tern{1 2} <value>, <mask> (see page 534)	:TRIGger:SEQuence:PAT Tern{1 2}? (see page 534)	<value> ::= integer or <string> <mask> ::= integer or <string> <string> ::= "0xnxxxxn" n ::= {0,...,9 A,...,F}
:TRIGger:SEQuence:RES et <value> (see page 535)	:TRIGger:SEQuence:RES et? (see page 535)	<value> ::= {NONE PATtern1,ENTERed PATtern1,EXITed EDGE1 PATtern1,AND,EDGE1 PATtern2,ENTERed PATtern2,EXITed EDGE2 TIMER} Values used in find and trigger stages not available. EDGE2 not available if EDGE2,COUNT used in trigger stage.
:TRIGger:SEQuence:TIM er <time_value> (see page 536)	:TRIGger:SEQuence:TIM er? (see page 536)	<time_value> ::= time from 10 ns to 10 seconds in NR3 format
:TRIGger:SEQuence:TRI Gger <value> (see page 537)	:TRIGger:SEQuence:TRI Gger? (see page 537)	<value> ::= {PATtern2,ENTERed PATtern2,EXITed EDGE2 PATtern2,AND,EDGE2 EDGE2,COUNT EDGE2,COUNT,NREFind}

:TRIGger:SEQuence:COUNT

N (see [page 740](#))

Command Syntax :TRIGger:SEQuence:COUNT <count>
 <count> ::= integer in NR1 format

The :TRIGger:SEQuence:COUNT command sets the sequencer edge counter resource. The edge counter is used in the trigger stage to determine the number of edges that must be found before the sequencer generates a trigger.

Query Syntax :TRIGger:SEQuence:COUNT?

The :TRIGger:SEQuence:COUNT? query returns the current sequencer edge counter setting.

Return Format <count><NL>
 <count> ::= integer in NR1 format

- See Also**
- "[Introduction to :TRIGger Commands](#)" on page 454
 - "[:TRIGger:SEQuence:TRIGger](#)" on page 537
 - "[:TRIGger:SEQuence:EDGE](#)" on page 532

:TRIGger:SEQuence:EDGE

N (see [page 740](#))

Command Syntax :TRIGger:SEQuence:EDGE{1 | 2} <source>, <slope>
 <source> ::= {CHANnel<n> | EXTernal} for the DSO models
 <source> ::= {CHANnel<n> | DIGital0,..,DIGital15} for the MSO models
 <slope> ::= {POSitive | NEGative}
 <n> ::= {1 | 2 | 3 | 4} for the four channel oscilloscope models
 <n> ::= {1 | 2} for the two channel oscilloscope models

The :TRIGger:SEQuence:EDGE<n> command defines the specified sequencer edge resource according to the specified <source> and <slope>. To disable an edge resource, set its <source> to NONE. In this case, <slope> has no meaning.

Query Syntax :TRIGger:SEQuence:EDGE{1 | 2}?

The :TRIGger:SEQuence:EDGE<n>? query returns the specified sequencer edge resource setting. If the edge resource is disabled, the returned <source> value is NONE. In this case, the <slope> is undefined.

Return Format <source>, <slope><NL>

- See Also**
- ["Introduction to :TRIGger Commands"](#) on page 454
 - [":TRIGger:SEQuence:FIND"](#) on page 533
 - [":TRIGger:SEQuence:TRIGger"](#) on page 537
 - [":TRIGger:SEQuence:RESet"](#) on page 535
 - [":TRIGger:SEQuence:COUNT"](#) on page 531

:TRIGger:SEQuence:FIND

N (see [page 740](#))

Command Syntax :TRIGger:SEQuence:FIND <value>
 <value> ::= {PATTern1,ENTerEd | PATTern1,EXITed | EDGE1
 | PATTern1,AND,EDGE1}

The :TRIGger:SEQuence:FIND command specifies the find stage of a sequence trigger. This command accepts three program data parameters; you can use NONE to fill out the parameter list (for example, "EDGE1,NONE,NONE").

PATTern1 is specified with the ":TRIGger:SEQuence:PATTern" command. EDGE1 is specified with the :TRIGger:SEQuence:EDGE command.

Query Syntax :TRIGger:SEQuence:FIND?

The :TRIGger:SEQuence:FIND? query returns the find stage specification for a sequence trigger. NONE is returned for unused parameters.

Return Format <find_value><NL>
 <find_value> ::= {PATT1,ENT,NONE | PATT1,EXIT,NONE | EDGE1,NONE,NONE
 | PATT1,AND,EDGE1}

- See Also**
- ["Introduction to :TRIGger Commands"](#) on page 454
 - [":TRIGger:SEQuence:PATTern"](#) on page 534
 - [":TRIGger:SEQuence:EDGE"](#) on page 532
 - [":TRIGger:SEQuence:TRIGger"](#) on page 537
 - [":TRIGger:SEQuence:RESet"](#) on page 535

:TRIGger:SEQuence:PATtern

N (see page 740)

Command Syntax :TRIGger:SEQuence:PATtern{1 | 2} <value>,<mask>
 <value> ::= integer or <string>
 <mask> ::= integer or <string>
 <string> ::= "0xnnnnnn" where n ::= {0,...,9 | A,...,F}

The :TRIGger:SEQuence:PATtern<n> command defines the specified sequence pattern resource according to the value and the mask. For both <value> and <mask>, each bit corresponds to a possible trigger channel. The bit assignments vary by instrument:

Oscilloscope Models	Value and Mask Bit Assignments
4 analog + 16 digital channels (mixed-signal)	Bits 0 through 15 - digital channels 0 through 15. Bits 16 through 19 - analog channels 1 through 4.
2 analog + 16 digital channels (mixed-signal)	Bits 0 through 15 - digital channels 0 through 15. Bits 16 and 17 - analog channels 1 and 2.
4 analog channels only	Bits 0 through 3 - analog channels 1 through 4. Bit 4 - external trigger.
2 analog channels only	Bits 0 and 1 - analog channels 1 and 2. Bit 4 - external trigger.

Set a <value> bit to "0" to set the pattern for the corresponding channel to low. Set a <value> bit to "1" to set the pattern to high.

Set a <mask> bit to "0" to ignore the data for the corresponding channel. Only channels with a "1" set on the appropriate mask bit are used.

Query Syntax :TRIGger:SEQuence:PATtern{1 | 2}?

The :TRIGger:SEQuence:PATtern<n>? query returns the current settings of the specified pattern resource.

Return Format <value>,<mask><NL>

- See Also**
- "Introduction to :TRIGger Commands" on page 454
 - ":TRIGger:SEQuence:FIND" on page 533
 - ":TRIGger:SEQuence:TRIGger" on page 537
 - ":TRIGger:SEQuence:RESet" on page 535

:TRIGger:SEQuence:RESet

N (see [page 740](#))

Command Syntax :TRIGger:SEQuence:RESet <value>

```
<value> ::= {NONE | PATTErn1,ENTERed | PATTErn1,EXITed | EDGE1
            | PATTErn1,AND,EDGE1 | PATTErn2,ENTERed | PATTErn2,EXITed
            | EDGE2 | TIMer}
```

Values used in find and trigger stages are not available. EDGE2 is not available if EDGE2,COUNT is used in trigger stage.

The :TRIGger:SEQuence:RESet command specifies the reset stage of a sequence trigger. In multi-level trigger specifications, you may find a pattern, then search for another in sequence, but reset the entire search to the beginning if another condition occurs. This command accepts three program data parameters; you can use NONE to fill out the parameter list (for example, "EDGE1,NONE,NONE").

PATTErn1 and PATTErn2 are specified with the :TRIGger:SEQuence:PATTErn command. EDGE1 and EDGE2 are specified with the :TRIGger:SEQuence:EDGE command. TIMer is specified with the :TRIGger:SEQuence:TIMer command.

Query Syntax :TRIGger:SEQuence:RESet?

The :TRIGger:SEQuence:RESet? query returns the reset stage specification for a sequence trigger. NONE is returned for unused parameters.

Return Format <reset_value><NL>

```
<reset_value> ::= {NONE,NONE,NONE | PATT1,ENT,NONE | PATT1,EXIT,NONE
                  | EDGE1,NONE,NONE | PATT1,AND,EDGE1 | PATT2,ENT,NONE
                  | PATT2,EXIT,NONE | EDGE2,NONE,NONE | TIM,NONE,NONE}
```

- See Also**
- "[Introduction to :TRIGger Commands](#)" on page 454
 - "[:TRIGger:SEQuence:PATTErn](#)" on page 534
 - "[:TRIGger:SEQuence:EDGE](#)" on page 532
 - "[:TRIGger:SEQuence:TIMer](#)" on page 536
 - "[:TRIGger:SEQuence:FIND](#)" on page 533
 - "[:TRIGger:SEQuence:TRIGger](#)" on page 537

:TRIGger:SEQuence:TIMer

N (see [page 740](#))

Command Syntax :TRIGger:SEQuence:TIMer <time_value>

<time_value> ::= time in seconds in NR1 format

The :TRIGger:SEQuence:TIMer command sets the sequencer timer resource in seconds from 10 ns to 10 s. The timer is used in the reset stage to determine how long to wait for the trigger to occur before restarting.

Query Syntax :TRIGger:SEQuence:TIMer?

The :TRIGger:SEQuence:TIMer? query returns current sequencer timer setting.

Return Format <time value><NL>

<time_value> ::= time in seconds in NR1 format

- See Also**
- "[Introduction to :TRIGger Commands](#)" on page 454
 - "[:TRIGger:SEQuence:RESet](#)" on page 535

:TRIGger:SEQuence:TRIGger

N (see page 740)

Command Syntax :TRIGger:SEQuence:TRIGger <value>

```
<value> ::= {PATTern2,ENTerEd | PATTern2,EXITed | EDGE2
            | PATTern2,AND,EDGE2 | EDGE2,COUNT | EDGE2,COUNT,NREFind}
```

The :TRIGger:SEQuence:TRIGger command specifies the trigger stage of a sequence trigger. The sequence commands set various search terms. After all of these are found in sequence, the trigger condition itself is searched for. This command accepts three program data parameters; you can use NONE to fill out the parameter list (for example, "EDGE2,NONE,NONE").

PATTern2 is specified with the :TRIGger:SEQuence:PATTern command. EDGE2 is specified with the :TRIGger:SEQuence:EDGE command. COUNT is specified with the :TRIGger:SEQuence:COUNT command.

Query Syntax :TRIGger:SEQuence:TRIGger?

The :TRIGger:SEQuence:TRIGger? query returns the trigger stage specification for a sequence trigger. NONE is returned for unused parameters.

Return Format <trigger_value><NL>

```
<trigger_value> ::= {PATT2,ENT,NONE | PATT2,EXIT,NONE
                    | EDGE2,NONE,NONE | PATT2,AND,EDGE2
                    | EDGE2,COUN,NONE | EDGE2,COUN,NREF}
```

- See Also**
- "Introduction to :TRIGger Commands" on page 454
 - ":TRIGger:SEQuence:PATTern" on page 534
 - ":TRIGger:SEQuence:EDGE" on page 532
 - ":TRIGger:SEQuence:COUNT" on page 531
 - ":TRIGger:SEQuence:FIND" on page 533
 - ":TRIGger:SEQuence:RESet" on page 535
 - ":TRIGger:SEQuence:RESet" on page 535

:TRIGger:SPI Commands

Table 81 :TRIGger:SPI Commands Summary

Command	Query	Options and Query Returns
:TRIGger:SPI:CLOCK:SL OPe <slope> (see page 539)	:TRIGger:SPI:CLOCK:SL OPe? (see page 539)	<slope> ::= {NEGative POSitive}
:TRIGger:SPI:CLOCK:TI Meout <time_value> (see page 540)	:TRIGger:SPI:CLOCK:TI Meout? (see page 540)	<time_value> ::= time in seconds in NR1 format
:TRIGger:SPI:FRAMing <value> (see page 541)	:TRIGger:SPI:FRAMing? (see page 541)	<value> ::= {CHIPselect NOTChipselect TIMEout}
:TRIGger:SPI:PATtern: DATA <value>, <mask> (see page 542)	:TRIGger:SPI:PATtern: DATA? (see page 542)	<value> ::= integer or <string> <mask> ::= integer or <string> <string> ::= "0xnxxxxx" where n ::= {0,...,9 A,...,F}
:TRIGger:SPI:PATtern: WIDTh <width> (see page 543)	:TRIGger:SPI:PATtern: WIDTh? (see page 543)	<width> ::= integer from 4 to 32 in NR1 format
:TRIGger:SPI:SOURce:C LOCK <source> (see page 544)	:TRIGger:SPI:SOURce:C LOCK? (see page 544)	<value> ::= {CHANnel<n> EXTernal} for the DSO models <value> ::= {CHANnel<n> DIGital0,...,DIGital15} for the MSO models <n> ::= 1-2 or 1-4 in NR1 format
:TRIGger:SPI:SOURce:D ATA <source> (see page 545)	:TRIGger:SPI:SOURce:D ATA? (see page 545)	<value> ::= {CHANnel<n> EXTernal} for the DSO models <value> ::= {CHANnel<n> DIGital0,...,DIGital15} for the MSO models <n> ::= 1-2 or 1-4 in NR1 format
:TRIGger:SPI:SOURce:F RAME <source> (see page 546)	:TRIGger:SPI:SOURce:F RAME? (see page 546)	<value> ::= {CHANnel<n> EXTernal} for the DSO models <value> ::= {CHANnel<n> DIGital0,...,DIGital15} for the MSO models <n> ::= 1-2 or 1-4 in NR1 format

:TRIGger:SPI:CLOCK:SLOPe

N (see [page 740](#))

Command Syntax :TRIGger:SPI:CLOCK:SLOPe <slope>
 <slope> ::= {NEGative | POSitive}

The :TRIGger:SPI:CLOCK:SLOPe command specifies the rising edge (POSitive) or falling edge (NEGative) of the SPI clock source that will clock in the data.

Query Syntax :TRIGger:SPI:CLOCK:SLOPe?

The :TRIGger:SPI:CLOCK:SLOPe? query returns the current SPI clock source slope.

Return Format <slope><NL>
 <slope> ::= {NEG | POS}

- See Also**
- "[Introduction to :TRIGger Commands](#)" on page 454
 - "[:TRIGger:SPI:CLOCK:TIMEout](#)" on page 540
 - "[:TRIGger:SPI:SOURce:CLOCK](#)" on page 544

:TRIGger:SPI:CLOCK:TIMEout

N (see [page 740](#))

Command Syntax :TRIGger:SPI:CLOCK:TIMEout <time_value>

<time_value> ::= time in seconds in NR1 format

The :TRIGger:SPI:CLOCK:TIMEout command sets the SPI signal clock timeout resource in seconds from 500 ns to 10 s when the :TRIGger:SPI:FRAMing command is set to TIMEout. The timer is used to frame a signal by a clock timeout.

Query Syntax :TRIGger:SPI:CLOCK:TIMEout?

The :TRIGger:SPI:CLOCK:TIMEout? query returns current SPI clock timeout setting.

Return Format <time value><NL>

<time_value> ::= time in seconds in NR1 format

- See Also**
- ["Introduction to :TRIGger Commands"](#) on page 454
 - [":TRIGger:SPI:CLOCK:SLOPe"](#) on page 539
 - [":TRIGger:SPI:SOURce:CLOCK"](#) on page 544
 - [":TRIGger:SPI:FRAMing"](#) on page 541

:TRIGger:SPI:FRAMing

N (see [page 740](#))

Command Syntax :TRIGger:SPI:FRAMing <value>

<value> ::= {CHIPselect | NOTChipselect | TIMEout}

The :TRIGger:SPI:FRAMing command sets the SPI trigger framing value. If TIMEout is selected, the timeout value is set by the :TRIGger:SPI:CLOCK:TIMEout command.

Query Syntax :TRIGger:SPI:FRAMing?

The :TRIGger:SPI:FRAMing? query returns the current SPI framing value.

Return Format <value><NL>

<value> ::= {CHIPselect | NOTChipselect | TIMEout}

- See Also**
- "[Introduction to :TRIGger Commands](#)" on page 454
 - "[:TRIGger:MODE](#)" on page 460
 - "[:TRIGger:SPI:CLOCK:TIMEout](#)" on page 540
 - "[:TRIGger:SPI:SOURce:FRAME](#)" on page 546

:TRIGger:SPI:PATtern:DATA

N (see [page 740](#))

Command Syntax :TRIGger:SPI:PATtern:DATA <value>,<mask>

<value> ::= integer or <string>

<mask> ::= integer or <string>

<string> ::= "0xnmmnnn" where n ::= {0,...,9 | A,...,F}

The :TRIGger:SPI:PATtern:DATA command defines the SPI data pattern resource according to the value and the mask. This pattern, along with the data width, control the data pattern searched for in the data stream.

Set a <value> bit to "0" to set the corresponding bit in the data pattern to low. Set a <value> bit to "1" to set the bit to high.

Set a <mask> bit to "0" to ignore that bit in the data stream. Only bits with a "1" set on the mask are used.

Query Syntax :TRIGger:SPI:PATtern:DATA?

The :TRIGger:SPI:PATtern:DATA? query returns the current settings of the specified SPI data pattern resource.

Return Format <value> , <mask><NL>

- See Also**
- ["Introduction to :TRIGger Commands"](#) on page 454
 - [":TRIGger:SPI:PATtern:WIDTh"](#) on page 543
 - [":TRIGger:SPI:SOURce:DATA"](#) on page 545

:TRIGger:SPI:PATtern:WIDTh

N (see [page 740](#))

Command Syntax :TRIGger:SPI:PATtern:WIDTh <width>
 <width> ::= integer from 4 to 32 in NR1 format

The :TRIGger:SPI:PATtern:WIDTh command sets the width of the SPI data pattern anywhere from 4 bits to 32 bits.

Query Syntax :TRIGger:SPI:PATtern:WIDTh?

The :TRIGger:SPI:PATtern:WIDTh? query returns the current SPI data pattern width setting.

Return Format <width><NL>
 <width> ::= integer from 4 to 32 in NR1 format

- See Also**
- "[Introduction to :TRIGger Commands](#)" on page 454
 - "[:TRIGger:SPI:PATtern:DATA](#)" on page 542
 - "[:TRIGger:SPI:SOURce:DATA](#)" on page 545

:TRIGger:SPI:SOURce:CLOCK

N (see [page 740](#))

Command Syntax :TRIGger:SPI:SOURce:CLOCK <source>

<source> ::= {CHANnel<n> | EXTernal} for the DSO models

<source> ::= {CHANnel<n> | DIGital0,..,DIGital15} for the MSO models

<n> ::= {1 | 2 | 3 | 4} for the four channel oscilloscope models

<n> ::= {1 | 2} for the two channel oscilloscope models

The :TRIGger:SPI:SOURce:CLOCK command sets the source for the SPI serial clock.

Query Syntax :TRIGger:SPI:SOURce:CLOCK?

The :TRIGger:SPI:SOURce:CLOCK? query returns the current source for the SPI serial clock.

Return Format <source><NL>

- See Also**
- "[Introduction to :TRIGger Commands](#)" on page 454
 - "[:TRIGger:SPI:CLOCK:SLOPe](#)" on page 539
 - "[:TRIGger:SPI:CLOCK:TIMEout](#)" on page 540
 - "[:TRIGger:SPI:SOURce:FRAMe](#)" on page 546
 - "[:TRIGger:SPI:SOURce:DATA](#)" on page 545

:TRIGger:SPI:SOURce:DATA

N (see [page 740](#))

Command Syntax :TRIGger:SPI:SOURce:DATA <source>

<source> ::= {CHANnel<n> | EXTernal} for the DSO models

<source> ::= {CHANnel<n> | DIGital0,...,DIGital15} for the MSO models

<n> ::= {1 | 2 | 3 | 4} for the four channel oscilloscope models

<n> ::= {1 | 2} for the two channel oscilloscope models

The :TRIGger:SPI:SOURce:DATA command sets the source for the SPI serial data.

Query Syntax :TRIGger:SPI:SOURce:DATA?

The :TRIGger:SPI:SOURce:DATA? query returns the current source for the SPI serial data.

Return Format <source><NL>

- See Also**
- ["Introduction to :TRIGger Commands"](#) on page 454
 - [":TRIGger:SPI:SOURce:CLOCK"](#) on page 544
 - [":TRIGger:SPI:SOURce:FRAMe"](#) on page 546
 - [":TRIGger:SPI:PATTern:DATA"](#) on page 542
 - [":TRIGger:SPI:PATTern:WIDTh"](#) on page 543

:TRIGger:SPI:SOURce:FRAME

N (see [page 740](#))

Command Syntax :TRIGger:SPI:SOURce:FRAME <source>

<source> ::= {CHANnel<n> | EXTernal} for the DSO models

<source> ::= {CHANnel<n> | DIGital0,..,DIGital15} for the MSO models

<n> ::= {1 | 2 | 3 | 4} for the four channel oscilloscope models

<n> ::= {1 | 2} for the two channel oscilloscope models

The :TRIGger:SPI:SOURce:FRAME command sets the frame source when :TRIGger:SPI:FRAMing is set to CHIPselect or NOTChipselect.

Query Syntax :TRIGger:SPI:SOURce:FRAME?

The :TRIGger:SPI:SOURce:FRAME? query returns the current frame source for the SPI serial frame.

Return Format <source><NL>

- See Also**
- ["Introduction to :TRIGger Commands"](#) on page 454
 - [":TRIGger:SPI:SOURce:CLOCK"](#) on page 544
 - [":TRIGger:SPI:SOURce:DATA"](#) on page 545
 - [":TRIGger:SPI:FRAMing"](#) on page 541

:TRIGger:TV Commands

Table 82 :TRIGger:TV Commands Summary

Command	Query	Options and Query Returns
:TRIGger:TV:LINE <line number> (see page 548)	:TRIGger:TV:LINE? (see page 548)	<line number> ::= integer in NR1 format
:TRIGger:TV:MODE <tv mode> (see page 549)	:TRIGger:TV:MODE? (see page 549)	<tv mode> ::= {FIELD1 FIELD2 AFIELDS ALINES LINE VERTICAL LFIELD1 LFIELD2 LALTERNATE LVERTICAL}
:TRIGger:TV:POLarity <polarity> (see page 550)	:TRIGger:TV:POLarity? (see page 550)	<polarity> ::= {POSitive NEGative}
:TRIGger:TV:SOURce <source> (see page 551)	:TRIGger:TV:SOURce? (see page 551)	<source> ::= {CHANnel<n>} <n> ::= 1-2 or 1-4 integer in NR1 format
:TRIGger:TV:STANdard <standard> (see page 552)	:TRIGger:TV:STANdard? (see page 552)	<standard> ::= {GENeric NTSC PALM PAL SECam {P480L60HZ P480} {P720L60HZ P720} {P1080L24HZ P1080} P1080L25HZ {I1080L50HZ I1080} I1080L60HZ}

:TRIGger:TV:LINE

N (see [page 740](#))

Command Syntax :TRIGger:TV:LINE <line_number>

<line_number> ::= integer in NR1 format

The :TRIGger:TV:LINE command allows triggering on a specific line of video. The line number limits vary with the standard and mode, as shown in the following table.

Table 83 TV Trigger Line Number Limits

TV Standard	Mode				
	LINE	LField1	LField2	LALternate	VERTical
NTSC		1 to 263	1 to 262	1 to 262	
PAL		1 to 313	314 to 625	1 to 312	
PAL-M		1 to 263	264 to 525	1 to 262	
SECAM		1 to 313	314 to 625	1 to 312	
GENERIC		1 to 1024	1 to 1024		1 to 1024
P480L60HZ	1 to 525				
P720L60HZ	1 to 750				
P1080L24HZ	1 to 1125				
P1080L25HZ	1 to 1125				
I1080L50HZ	1 to 1125				
I1080L60HZ	1 to 1125				

Query Syntax :TRIGger:TV:LINE?

The :TRIGger:TV:LINE? query returns the current TV trigger line number setting.

Return Format <line_number><NL>

<line_number> ::= integer in NR1 format

- See Also**
- ["Introduction to :TRIGger Commands"](#) on page 454
 - [":TRIGger:TV:STANdard"](#) on page 552
 - [":TRIGger:TV:MODE"](#) on page 549

:TRIGger:TV:MODE

N (see [page 740](#))

Command Syntax :TRIGger:TV:MODE <mode>

```
<mode> ::= {FIEld1 | FIEld2 | AFIElds | ALINes | LINE | VERTical
            | LFIeld1 | LFIeld2 | LALTernate | LVERTical}
```

The :TRIGger:TV:MODE command selects the TV trigger mode and field. The LVERTical parameter is only available when :TRIGger:TV:STANdard is GENERic. The LALTernate parameter is not available when :TRIGger:TV:STANdard is GENERic.

Old forms for <mode> are accepted:

<mode>	Old Forms Accepted
FIEld1	F1
FIEld2	F2
AFIElds	ALLFields, ALLFLDS
ALINes	ALLLines
LFIeld1	LINEF1, LINEFIELD1
LFIeld2	LINEF2, LINEFIELD2
LALTernate	LINEAlt
LVERTical	LINEVert

Query Syntax :TRIGger:TV:MODE?

The :TRIGger:TV:MODE? query returns the TV trigger mode.

Return Format <value><NL>

```
<value> ::= {FIE1 | FIE2 | AFI | ALIN | LINE | VERT | LFI1 | LFI2
            | LALT | LVER}
```

- See Also**
- ["Introduction to :TRIGger Commands"](#) on page 454
 - [":TRIGger:TV:STANdard"](#) on page 552
 - [":TRIGger:MODE"](#) on page 460

:TRIGger:TV:POLarity

N (see [page 740](#))

Command Syntax :TRIGger:TV:POLarity <polarity>
<polarity> ::= {POSitive | NEGative}

The :TRIGger:TV:POLarity command sets the polarity for the TV trigger.

Query Syntax :TRIGger:TV:POLarity?

The :TRIGger:TV:POLarity? query returns the TV trigger polarity.

Return Format <polarity><NL>
<polarity> ::= {POS | NEG}

- See Also**
- ["Introduction to :TRIGger Commands"](#) on page 454
 - [":TRIGger:MODE"](#) on page 460
 - [":TRIGger:TV:SOURce"](#) on page 551

:TRIGger:TV:SOURce

N (see [page 740](#))

Command Syntax :TRIGger:TV:SOURce <source>

<source> ::= {CHANnel<n>}

<n> ::= {1 | 2 | 3 | 4} for the four channel oscilloscope models

<n> ::= {1 | 2} for the two channel oscilloscope models

The :TRIGger:TV:SOURce command selects the channel used to produce the trigger.

Query Syntax :TRIGger:TV:SOURce?

The :TRIGger:TV:SOURce? query returns the current TV trigger source.

Return Format <source><NL>

<source> ::= {CHAN<n>}

- See Also**
- ["Introduction to :TRIGger Commands"](#) on page 454
 - [":TRIGger:MODE"](#) on page 460
 - [":TRIGger:TV:POLarity"](#) on page 550

- Example Code**
- ["Example Code"](#) on page 491

:TRIGger:TV:STANdard

N (see page 740)

Command Syntax :TRIGger:TV:STANdard <standard>

```
<standard> ::= {GENERIC | NTSC | PALM | PAL | SECAM  
               | {P480L60HZ | P480} | {P720L60HZ | P720}  
               | {P1080L24HZ | P1080} | P1080L25HZ  
               | {I1080L50HZ | I1080} | I1080L60HZ}
```

The :TRIGger:TV:STANdard command selects the video standard. GENERIC mode is non-interlaced.

Query Syntax :TRIGger:TV:STANdard?

The :TRIGger:TV:STANdard? query returns the current TV trigger standard setting.

Return Format <standard><NL>

```
<standard> ::= {GEN | NTSC | PALM | PAL | SEC | P480L60HZ | P760L60HZ  
               | P1080L24HZ | P1080L25HZ | I1080L50HZ | I1080L60HZ}
```

:TRIGger:UART Commands

Table 84 :TRIGger:UART Commands Summary

Command	Query	Options and Query Returns
:TRIGger:UART:BASE <base> (see page 555)	:TRIGger:UART:BASE? (see page 555)	<base> ::= {ASCIi HEX}
:TRIGger:UART:BAUDrate <baudrate> (see page 556)	:TRIGger:UART:BAUDrate? (see page 556)	<baudrate> ::= integer from 1200 to 3000000 in 100 b/s increments
:TRIGger:UART:BITorder <bitorder> (see page 557)	:TRIGger:UART:BITorder? (see page 557)	<bitorder> ::= {LSBFirst MSBFirst}
:TRIGger:UART:BURSt <value> (see page 558)	:TRIGger:UART:BURSt? (see page 558)	<value> ::= {OFF 1 to 4096 in NR1 format}
:TRIGger:UART:DATA <value> (see page 559)	:TRIGger:UART:DATA? (see page 559)	<value> ::= 8-bit integer from 0-255 (0x00-0xff) in decimal, <hexadecimal>, <binary>, or <quoted_string> format <hexadecimal> ::= #Hnn where n ::= {0,...,9 A,...,F} for hexadecimal <binary> ::= #Bnn...n where n ::= {0 1} for binary <quoted_string> ::= any of the 128 valid 7-bit ASCII characters (or standard abbreviations)
:TRIGger:UART:IDLE <time_value> (see page 560)	:TRIGger:UART:IDLE? (see page 560)	<time_value> ::= time from 1 us to 10 s in NR3 format
:TRIGger:UART:PARity <parity> (see page 561)	:TRIGger:UART:PARity? (see page 561)	<parity> ::= {EVEN ODD NONE}
:TRIGger:UART:POLarity <polarity> (see page 562)	:TRIGger:UART:POLarity? (see page 562)	<polarity> ::= {HIGH LOW}
:TRIGger:UART:QUALifier <value> (see page 563)	:TRIGger:UART:QUALifier? (see page 563)	<value> ::= {EQUAL NOTequal GREATERthan LESSthan}

Table 84 :TRIGger:UART Commands Summary (continued)

Command	Query	Options and Query Returns
:TRIGger:UART:SOURce: RX <source> (see page 564)	:TRIGger:UART:SOURce: RX? (see page 564)	<source> ::= {CHANnel<n> EXTernal} for DSO models <source> ::= {CHANnel<n> DIGital0,...,DIGital15} for MSO models <n> ::= 1-2 or 1-4 in NR1 format
:TRIGger:UART:SOURce: TX <source> (see page 565)	:TRIGger:UART:SOURce: TX? (see page 565)	<source> ::= {CHANnel<n> EXTernal} for DSO models <source> ::= {CHANnel<n> DIGital0,...,DIGital15} for MSO models <n> ::= 1-2 or 1-4 in NR1 format
:TRIGger:UART:TYPE <value> (see page 566)	:TRIGger:UART:TYPE? (see page 566)	<value> ::= {RSTArt RSTOp RDATA RD1 RD0 RDX PARityerror TSTArt TSTOp TDATA TD1 TD0 TDX}
:TRIGger:UART:WIDTh <width> (see page 567)	:TRIGger:UART:WIDTh? (see page 567)	<width> ::= {5 6 7 8 9}

:TRIGger:UART:BASE

N (see [page 740](#))

Command Syntax :TRIGger:UART:BASE <base>
 <base> ::= {ASCIi | HEX}

The :TRIGger:UART:BASE command sets the front panel UART/RS232 trigger setup data selection option:

- ASCii – front panel data selection is from ASCII values.
- HEX – front panel data selection is from hexadecimal values.

The :TRIGger:UART:BASE setting does not affect the :TRIGger:UART:DATA command which can always set data values using ASCII or hexadecimal values.

NOTE

The :TRIGger:UART:BASE command is independent of the :SBUS:UART:BASE command which affects decode only.

Query Syntax :TRIGger:UART:BASE?

The :TRIGger:UART:BASE? query returns the current UART base setting.

Return Format <base><NL>
 <base> ::= {ASC | HEX}

- See Also**
- ["Introduction to :TRIGger Commands"](#) on page 454
 - [":TRIGger:MODE"](#) on page 460
 - [":TRIGger:UART:DATA"](#) on page 559

:TRIGger:UART:BAUDrate

N (see [page 740](#))

Command Syntax :TRIGger:UART:BAUDrate <baudrate>

<baudrate> ::= integer from 1200 to 3000000 in 100 b/s increments

The :TRIGger:UART:BAUDrate command selects the bit rate (in bps) for the serial decoder and/or trigger when in UART mode. The baud rate can be set from 1200 b/s to 3 Mb/s in 100 b/s increments. If you enter a baud rate that is not divisible by 100 b/s, the baud rate is set to the nearest baud rate divisible by 100 b/s.

If the baud rate you select does not match the system baud rate, false triggers may occur.

Query Syntax :TRIGger:UART:BAUDrate?

The :TRIGger:UART:BAUDrate? query returns the current UART baud rate setting.

Return Format <baudrate><NL>

<baudrate> ::= integer from 1200 to 3000000 in 100 b/s increments

- See Also**
- "[Introduction to :TRIGger Commands](#)" on page 454
 - "[:TRIGger:MODE](#)" on page 460
 - "[:TRIGger:UART:TYPE](#)" on page 566

:TRIGger:UART:BITorder

N (see [page 740](#))

Command Syntax :TRIGger:UART:BITorder <bitorder>

<bitorder> ::= {LSBFirst | MSBFirst}

The :TRIGger:UART:BITorder command specifies the order of transmission used by the physical Tx and Rx input signals for the serial decoder and/or trigger when in UART mode. LSBFirst sets the least significant bit of each message "byte" as transmitted first. MSBFirst sets the most significant bit as transmitted first.

Query Syntax :TRIGger:UART:BITorder?

The :TRIGger:UART:BITorder? query returns the current UART bit order setting.

Return Format <bitorder><NL>

<bitorder> ::= {LSBF | MSBF}

- See Also**
- ["Introduction to :TRIGger Commands"](#) on page 454
 - [":TRIGger:MODE"](#) on page 460
 - [":TRIGger:UART:TYPE"](#) on page 566
 - [":TRIGger:UART:SOURce:RX"](#) on page 564
 - [":TRIGger:UART:SOURce:TX"](#) on page 565

:TRIGger:UART:BURSt

N (see [page 740](#))

Command Syntax :TRIGger:UART:BURSt <value>
<value> ::= {OFF | 1 to 4096 in NR1 format}

The :TRIGger:UART:BURSt command selects the burst value (Nth frame after idle period) in the range 1 to 4096 or OFF, for the trigger when in UART mode.

Query Syntax :TRIGger:UART:BURSt?

The :TRIGger:UART:BURSt? query returns the current UART trigger burst value.

Return Format <value><NL>
<value> ::= {OFF | 1 to 4096 in NR1 format}

- See Also**
- "[Introduction to :TRIGger Commands](#)" on page 454
 - "[:TRIGger:MODE](#)" on page 460
 - "[:TRIGger:UART:IDLE](#)" on page 560
 - "[:TRIGger:UART:TYPE](#)" on page 566

:TRIGger:UART:DATA

N (see page 740)

Command Syntax :TRIGger:UART:DATA <value>

<value> ::= 8-bit integer from 0-255 (0x00-0xff) in decimal, <hexadecimal>, <binary>, or <quoted_string> format

<hexadecimal> ::= #Hnn where n ::= {0,...,9 | A,...,F} for hexadecimal

<binary> ::= #Bnn...n where n ::= {0 | 1} for binary

<quoted_string> ::= any of the 128 valid 7-bit ASCII characters (or standard abbreviations)

The :TRIGger:UART:DATA command selects the data byte value (0x00 to 0xFF) for the trigger QUALifier when in UART mode. The data value is used when one of the RD or TD trigger types is selected.

When entering an ASCII character via the quoted string, it must be one of the 128 valid characters (case-sensitive): "NUL", "SOH", "STX", "ETX", "EOT", "ENQ", "ACK", "BEL", "BS", "HT", "LF", "VT", "FF", "CR", "SO", "SI", "DLE", "DC1", "DC2", "DC3", "DC4", "NAK", "SYN", "ETB", "CAN", "EM", "SUB", "ESC", "FS", "GS", "RS", "US", "SP", "!", "\", "#", "\$", "%", "&", "\", "(", ")", "*", "+", ",", "-", ".", "/", "0", "1", "2", "3", "4", "5", "6", "7", "8", "9", ":", ";", "<", "=", ">", "?", "@", "A", "B", "C", "D", "E", "F", "G", "H", "I", "J", "K", "L", "M", "N", "O", "P", "Q", "R", "S", "T", "U", "V", "W", "X", "Y", "Z", "[", "\\", "]", "^", "_", "`", "a", "b", "c", "d", "e", "f", "g", "h", "i", "j", "k", "l", "m", "n", "o", "p", "q", "r", "s", "t", "u", "v", "w", "x", "y", "z", "{", "|", "}", "~", or "DEL".

Query Syntax :TRIGger:UART:DATA?

The :TRIGger:UART:DATA? query returns the current UART trigger data value.

Return Format <value><NL>

<value> ::= 8-bit integer in decimal from 0-255

- See Also**
- "Introduction to :TRIGger Commands" on page 454
 - ":TRIGger:MODE" on page 460
 - ":TRIGger:UART:BASE" on page 555
 - ":TRIGger:UART:TYPE" on page 566

:TRIGger:UART:IDLE

N (see [page 740](#))

Command Syntax :TRIGger:UART:IDLE <time_value>

<time_value> ::= time from 1 us to 10 s in NR3 format

The :TRIGger:UART:IDLE command selects the value of the idle period for burst trigger in the range from 1 us to 10 s when in UART mode.

Query Syntax :TRIGger:UART:IDLE?

The :TRIGger:UART:IDLE? query returns the current UART trigger idle period time.

Return Format <time_value><NL>

<time_value> ::= time from 1 us to 10 s in NR3 format

- See Also**
- "[Introduction to :TRIGger Commands](#)" on page 454
 - "[:TRIGger:MODE](#)" on page 460
 - "[:TRIGger:UART:BURSt](#)" on page 558
 - "[:TRIGger:UART:TYPE](#)" on page 566

:TRIGger:UART:PARity

N (see [page 740](#))

Command Syntax :TRIGger:UART:PARity <parity>

<parity> ::= {EVEN | ODD | NONE}

The :TRIGger:UART:PARity command selects the parity to be used with each message "byte" for the serial decoder and/or trigger when in UART mode.

Query Syntax :TRIGger:UART:PARity?

The :TRIGger:UART:PARity? query returns the current UART parity setting.

Return Format <parity><NL>

<parity> ::= {EVEN | ODD | NONE}

- See Also**
- "[Introduction to :TRIGger Commands](#)" on page 454
 - "[:TRIGger:MODE](#)" on page 460
 - "[:TRIGger:UART:TYPE](#)" on page 566

:TRIGger:UART:POLarity

N (see [page 740](#))

Command Syntax :TRIGger:UART:POLarity <polarity>
<polarity> ::= {HIGH | LOW}

The :TRIGger:UART:POLarity command selects the polarity as idle low or idle high for the serial decoder and/or trigger when in UART mode.

Query Syntax :TRIGger:UART:POLarity?

The :TRIGger:UART:POLarity? query returns the current UART polarity setting.

Return Format <polarity><NL>
<polarity> ::= {HIGH | LOW}

- See Also**
- "[Introduction to :TRIGger Commands](#)" on page 454
 - "[:TRIGger:MODE](#)" on page 460
 - "[:TRIGger:UART:TYPE](#)" on page 566

:TRIGger:UART:QUALifier

N (see [page 740](#))

Command Syntax :TRIGger:UART:QUALifier <value>
 <value> ::= {EQUAL | NOTequal | GREaterthan | LESSthan}

The :TRIGger:UART:QUALifier command selects the data qualifier when :TYPE is set to RDATA, RD1, RD0, RDX, TDATA, TD1, TD0, or TDX for the trigger when in UART mode.

Query Syntax :TRIGger:UART:QUALifier?

The :TRIGger:UART:QUALifier? query returns the current UART trigger qualifier.

Return Format <value><NL>
 <value> ::= {EQU | NOT | GRE | LESS}

- See Also**
- ["Introduction to :TRIGger Commands"](#) on page 454
 - [":TRIGger:MODE"](#) on page 460
 - [":TRIGger:UART:TYPE"](#) on page 566

:TRIGger:UART:SOURce:RX

N (see [page 740](#))

Command Syntax :TRIGger:UART:SOURce:RX <source>

<source> ::= {CHANnel<n> | EXTernal} for the DSO models

<source> ::= {CHANnel<n> | DIGital0,...,DIGital15} for the MSO models

<n> ::= {1 | 2 | 3 | 4} for the four channel oscilloscope models

<n> ::= {1 | 2} for the two channel oscilloscope models

The :TRIGger:UART:SOURce:RX command controls which signal is used as the Rx source by the serial decoder and/or trigger when in UART mode.

Query Syntax :TRIGger:UART:SOURce:RX?

The :TRIGger:UART:SOURce:RX? query returns the current source for the UART Rx signal.

Return Format <source><NL>

- See Also**
- ["Introduction to :TRIGger Commands"](#) on page 454
 - [":TRIGger:MODE"](#) on page 460
 - [":TRIGger:UART:TYPE"](#) on page 566
 - [":TRIGger:UART:BITorder"](#) on page 557

:TRIGger:UART:SOURce:TX

N (see [page 740](#))

Command Syntax :TRIGger:UART:SOURce:TX <source>

<source> ::= {CHANnel<n> | EXTernal} for the DSO models

<source> ::= {CHANnel<n> | DIGital0,...,DIGital15} for the MSO models

<n> ::= {1 | 2 | 3 | 4} for the four channel oscilloscope models

<n> ::= {1 | 2} for the two channel oscilloscope models

The :TRIGger:UART:SOURce:TX command controls which signal is used as the Tx source by the serial decoder and/or trigger when in UART mode.

Query Syntax :TRIGger:UART:SOURce:TX?

The :TRIGger:UART:SOURce:TX? query returns the current source for the UART Tx signal.

Return Format <source><NL>

- See Also**
- ["Introduction to :TRIGger Commands"](#) on page 454
 - [":TRIGger:MODE"](#) on page 460
 - [":TRIGger:UART:TYPE"](#) on page 566
 - [":TRIGger:UART:BITorder"](#) on page 557

:TRIGger:UART:TYPE

N (see [page 740](#))

Command Syntax :TRIGger:UART:TYPE <value>

<value> ::= {RSTArt | RSTOp | RDATA | RD1 | RD0 | RDX | PARityerror
| TSTArt | TSTOp | TDATa | TD1 | TD0 | TDX}

The :TRIGger:UART:TYPE command selects the UART trigger type.

When one of the RD or TD types is selected, the :TRIGger:UART:DATA and :TRIGger:UART:QUALifier commands are used to specify the data value and comparison operator.

The RD1, RD0, RDX, TD1, TD0, and TDX types (for triggering on data and alert bit values) are only valid when a 9-bit width has been selected.

Query Syntax :TRIGger:UART:TYPE?

The :TRIGger:UART:TYPE? query returns the current UART trigger data value.

Return Format <value><NL>

<value> ::= {RSTA | RSTO | RDAT | RD1 | RD0 | RDX | PAR | TSTA |
TSTO | TDAT | TD1 | TD0 | TDX}

- See Also**
- "[Introduction to :TRIGger Commands](#)" on page 454
 - "[:TRIGger:MODE](#)" on page 460
 - "[:TRIGger:UART:DATA](#)" on page 559
 - "[:TRIGger:UART:QUALifier](#)" on page 563
 - "[:TRIGger:UART:WIDTH](#)" on page 567

:TRIGger:UART:WIDTH

N (see [page 740](#))

Command Syntax :TRIGger:UART:WIDTH <width>

<width> ::= {5 | 6 | 7 | 8 | 9}

The :TRIGger:UART:WIDTH command determines the number of bits (5-9) for each message "byte" for the serial decoder and/or trigger when in UART mode.

Query Syntax :TRIGger:UART:WIDTH?

The :TRIGger:UART:WIDTH? query returns the current UART width setting.

Return Format <width><NL>

<width> ::= {5 | 6 | 7 | 8 | 9}

- See Also**
- "[Introduction to :TRIGger Commands](#)" on page 454
 - "[:TRIGger:MODE](#)" on page 460
 - "[:TRIGger:UART:TYPE](#)" on page 566

:TRIGger:USB Commands

Table 85 :TRIGger:USB Commands Summary

Command	Query	Options and Query Returns
:TRIGger:USB:SOURce:D MINus <source> (see page 569)	:TRIGger:USB:SOURce:D MINus? (see page 569)	<source> ::= {CHANnel<n> EXTernal} for the DSO models <source> ::= {CHANnel<n> DIGital0,..,DIGital15} for the MSO models <n> ::= 1-2 or 1-4 in NR1 format
:TRIGger:USB:SOURce:D PLus <source> (see page 570)	:TRIGger:USB:SOURce:D PLus? (see page 570)	<source> ::= {CHANnel<n> EXTernal} for the DSO models <source> ::= {CHANnel<n> DIGital0,..,DIGital15} for the MSO models <n> ::= 1-2 or 1-4 in NR1 format
:TRIGger:USB:SPEEd <value> (see page 571)	:TRIGger:USB:SPEEd? (see page 571)	<value> ::= {LOW FULL}
:TRIGger:USB:TRIGger <value> (see page 572)	:TRIGger:USB:TRIGger? (see page 572)	<value> ::= {SOP EOP ENTersuspend EXITsuspend RESet}

:TRIGger:USB:SOURce:DMINus

N (see [page 740](#))

Command Syntax :TRIGger:USB:SOURce:DMINus <source>

<source> ::= {CHANnel<n> | EXTernal} for the DSO models

<source> ::= {CHANnel<n> | DIGital0,...,DIGital15} for the MSO models

<n> ::= {1 | 2 | 3 | 4} for the four channel oscilloscope models

<n> ::= {1 | 2} for the two channel oscilloscope models

The :TRIGger:USB:SOURce:DMINus command sets the source for the USB D- signal.

Query Syntax :TRIGger:USB:SOURce:DMINus?

The :TRIGger:USB:SOURce:DMINus? query returns the current source for the USB D- signal.

Return Format <source><NL>

- See Also**
- ["Introduction to :TRIGger Commands"](#) on page 454
 - [":TRIGger:MODE"](#) on page 460
 - [":TRIGger:USB:SOURce:DPLus"](#) on page 570
 - [":TRIGger:USB:TRIGger"](#) on page 572

:TRIGger:USB:SOURce:DPLus

N (see [page 740](#))

Command Syntax :TRIGger:USB:SOURce:DPLus <source>

<source> ::= {CHANnel<n> | EXTernal} for the DSO models

<source> ::= {CHANnel<n> | DIGital0,...,DIGital15} for the MSO models

<n> ::= {1 | 2 | 3 | 4} for the four channel oscilloscope models

<n> ::= {1 | 2} for the two channel oscilloscope models

The :TRIGger:USB:SOURce:DPLus command sets the source for the USB D+ signal.

Query Syntax :TRIGger:USB:SOURce:DPLus?

The :TRIGger:USB:SOURce:DPLus? query returns the current source for the USB D+ signal.

Return Format <source><NL>

- See Also**
- ["Introduction to :TRIGger Commands"](#) on page 454
 - [":TRIGger:MODE"](#) on page 460
 - [":TRIGger:USB:SOURce:DMINus"](#) on page 569
 - [":TRIGger:USB:TRIGger"](#) on page 572

:TRIGger:USB:SPEEd

N (see [page 740](#))

Command Syntax :TRIGger:USB:SPEEd <value>
 <value> ::= {LOW | FULL}

The :TRIGger:USB:SPEEd command sets the expected USB signal speed to be Low Speed (1.5 Mb/s) or Full Speed (12 Mb/s).

Query Syntax :TRIGger:USB:SPEEd?

The :TRIGger:USB:SPEEd? query returns the current speed value for the USB signal.

Return Format <value><NL>

- See Also**
- ["Introduction to :TRIGger Commands"](#) on page 454
 - [":TRIGger:MODE"](#) on page 460
 - [":TRIGger:USB:SOURce:DMINus"](#) on page 569
 - [":TRIGger:USB:SOURce:DPLus"](#) on page 570
 - [":TRIGger:USB:TRIGger"](#) on page 572

:TRIGger:USB:TRIGger

N (see [page 740](#))

Command Syntax :TRIGger:USB:TRIGger <value>

<value> ::= {SOP | EOP | ENTersuspend | EXITsuspend | RESet}

The :TRIGger:USB:TRIGger command sets where the USB trigger will occur:

- SOP – Start of packet.
- EOP – End of packet.
- ENTersuspend – Enter suspend state.
- EXITsuspend – Exit suspend state.
- RESet – Reset complete.

Query Syntax :TRIGger:USB:TRIGger?

The :TRIGger:USB:TRIGger? query returns the current USB trigger value.

Return Format <value><NL>

<value> ::= {SOP | EOP | ENTersuspend | EXITsuspend | RESet}

- See Also**
- ["Introduction to :TRIGger Commands"](#) on page 454
 - [":TRIGger:MODE"](#) on page 460
 - [":TRIGger:USB:SPEed"](#) on page 571

:WAVeform Commands

Provide access to waveform data. See "Introduction to :WAVeform Commands" on page 575.

Table 86 :WAVeform Commands Summary

Command	Query	Options and Query Returns
:WAVeform:BYTeorder <value> (see page 581)	:WAVeform:BYTeorder? (see page 581)	<value> ::= {LSBFirst MSBFirst}
n/a	:WAVeform:COUNT? (see page 582)	<count> ::= an integer from 1 to 65536 in NR1 format
n/a	:WAVeform:DATA? (see page 583)	<binary block length bytes>, <binary data> For example, to transmit 1000 bytes of data, the syntax would be: #800001000<1000 bytes of data><NL> 8 is the number of digits that follow 00001000 is the number of bytes to be transmitted <1000 bytes of data> is the actual data
:WAVeform:FORMat <value> (see page 585)	:WAVeform:FORMat? (see page 585)	<value> ::= {WORD BYTE ASCII}
:WAVeform:POINTs <# points> (see page 586)	:WAVeform:POINTs? (see page 586)	<# points> ::= {100 250 500 1000 <points_mode>} if waveform points mode is NORMAl <# points> ::= {100 250 500 1000 2000 ... 8000000 in 1-2-5 sequence <points_mode>} if waveform points mode is MAXimum or RAW <points_mode> ::= {NORMAl MAXimum RAW}
:WAVeform:POINTs:MODE <points_mode> (see page 588)	:WAVeform:POINTs:MODE ? (see page 589)	<points_mode> ::= {NORMAl MAXimum RAW}

Table 86 :WAVEform Commands Summary (continued)

Command	Query	Options and Query Returns
n/a	:WAVEform:PREamble? (see page 590)	<p><preamble_block> ::= <format NR1>, <type NR1>,<points NR1>,<count NR1>, <xincrement NR3>, <xorigin NR3>, <xreference NR1>,<yincrement NR3>, <yorigin NR3>, <yreference NR1></p> <p><format> ::= an integer in NR1 format:</p> <ul style="list-style-type: none"> • 0 for BYTE format • 1 for WORD format • 2 for ASCII format <p><type> ::= an integer in NR1 format:</p> <ul style="list-style-type: none"> • 0 for NORMAL type • 1 for PEAK detect type • 2 for AVERAGE type • 3 for HRESolution type <p><count> ::= Average count, or 1 if PEAK detect type or NORMAL; an integer in NR1 format</p>
n/a	:WAVEform:SEGmented:COUNT? (see page 593)	<count> ::= an integer from 2 to 2000 in NR1 format (with Option SGM)
n/a	:WAVEform:SEGmented:TAG? (see page 594)	<time_tag> ::= in NR3 format (with Option SGM)
:WAVEform:SOURce <source> (see page 595)	:WAVEform:SOURce? (see page 595)	<p><source> ::= {CHANnel<n> FUNCTION MATH SBUS} for DSO models</p> <p><source> ::= {CHANnel<n> POD{1 2} BUS{1 2} FUNCTION MATH SBUS} for MSO models</p> <p><n> ::= 1-2 or 1-4 in NR1 format</p>
:WAVEform:SOURce:SUBSource <subsource> (see page 599)	:WAVEform:SOURce:SUBSource? (see page 599)	<subsource> ::= {NONE RX} TX
n/a	:WAVEform:TYPE? (see page 600)	<return_mode> ::= {NORM PEAK AVER HRES}
:WAVEform:UNSigned {{0 OFF} {1 ON}} (see page 601)	:WAVEform:UNSigned? (see page 601)	{0 1}
:WAVEform:VIEW <view> (see page 602)	:WAVEform:VIEW? (see page 602)	<view> ::= {MAIN}

Table 86 :WAVeform Commands Summary (continued)

Command	Query	Options and Query Returns
n/a	:WAVeform:XINCrement? (see page 603)	<return_value> ::= x-increment in the current preamble in NR3 format
n/a	:WAVeform:XORigin? (see page 604)	<return_value> ::= x-origin value in the current preamble in NR3 format
n/a	:WAVeform:XREFerence? (see page 605)	<return_value> ::= 0 (x-reference value in the current preamble in NR1 format)
n/a	:WAVeform:YINCrement? (see page 606)	<return_value> ::= y-increment value in the current preamble in NR3 format
n/a	:WAVeform:YORigin? (see page 607)	<return_value> ::= y-origin in the current preamble in NR3 format
n/a	:WAVeform:YREFerence? (see page 608)	<return_value> ::= y-reference value in the current preamble in NR1 format

Introduction to :WAVeform Commands

The WAVeform subsystem is used to transfer data to a controller from the oscilloscope waveform memories. The queries in this subsystem will only operate when the channel selected by :WAVeform:SOURce is on.

Waveform Data and Preamble

The waveform record is actually contained in two portions: the preamble and waveform data. The waveform record must be read from the oscilloscope by the controller using two separate commands, :WAVeform:DATA (see [page 583](#)) and :WAVeform:PREamble (see [page 590](#)). The waveform data is the actual data acquired for each point in the specified source. The preamble contains the information for interpreting the waveform data, which includes the number of points acquired, the format of acquired data, and the type of acquired data. The preamble also contains the X and Y increments, origins, and references for the acquired data, so that word and byte data can be translated to time and voltage values.

Data Acquisition Types

There are three types of waveform acquisitions that can be selected for analog channels with the :ACquire:TYPE command (see [page 188](#)): NORMal, AVERage, PEAK, and HRESolution. Digital channels are always

acquired using NORMal. When the data is acquired using the :DIGitize command (see [page 142](#)) or :RUN command (see [page 166](#)), the data is placed in the channel buffer of the specified source.

Once you have acquired data with the :DIGitize command, the instrument is stopped. If the instrument is restarted (via the programming interface or the front panel), or if any instrument setting is changed, the data acquired with the :DIGitize command may be overwritten. You should first acquire the data with the :DIGitize command, then immediately read the data with the :WAVEform:DATA? query (see [page 583](#)) before changing any instrument setup.

A waveform record consists of either all of the acquired points or a subset of the acquired points. The number of points acquired may be queried using :ACQUIRE:POINTS? (see [page 180](#)).

Helpful Hints:

The number of points transferred to the computer is controlled using the :WAVEform:POINTS command (see [page 586](#)). If :WAVEform:POINTS MAXimum is specified and the instrument is not running (stopped), all of the points that are displayed are transferred. This can be as many as 4,000,000 in some operating modes or as many as 8,000,000 for a digital channel on the mixed signal oscilloscope. Fewer points may be specified to speed data transfers and minimize controller analysis time. The :WAVEform:POINTS may be varied even after data on a channel is acquired. However, this decimation may result in lost pulses and transitions. The number of points selected for transfer using :WAVEform:POINTS must be an even divisor of 1,000 or be set to MAXimum. :WAVEform:POINTS determines the increment between time buckets that will be transferred. If POINTS = MAXimum, the data cannot be decimated. For example:

- :WAVEform:POINTS 1000 – returns time buckets 0, 1, 2, 3, 4 ,.., 999.
- :WAVEform:POINTS 500 – returns time buckets 0, 2, 4, 6, 8 ,.., 998.
- :WAVEform:POINTS 250 – returns time buckets 0, 4, 8, 12, 16 ,.., 996.
- :WAVEform:POINTS 100 – returns time buckets 0, 10, 20, 30, 40 ,.., 990.

Analog Channel Data

NORMAL Data

Normal data consists of the last data point (hit) in each time bucket. This data is transmitted over the programming interface in a linear fashion starting with time bucket 0 and going through time bucket $n - 1$, where n is the number returned by the :WAVEform:POINTS? query (see [page 586](#)). Only the magnitude values of each data point are transmitted. The first voltage value corresponds to the first time bucket on the left side of the

screen and the last value corresponds to the next-to-last time bucket on the right side of the screen. Time buckets without data return 0. The time values for each data point correspond to the position of the data point in the data array. These time values are not transmitted.

AVERage Data

AVERage data consists of the average of the first *n* hits in a time bucket, where *n* is the value returned by the :ACQUIRE:COUNT query (see [page 177](#)). Time buckets that have fewer than *n* hits return the average of the data they do have. If a time bucket does not have any data in it, it returns 0.

This data is transmitted over the interface linearly, starting with time bucket 0 and proceeding through time bucket *n*-1, where *n* is the number returned by the :WAVEFORM:POINTS? query (see [page 586](#)). The first value corresponds to a point at the left side of the screen and the last value corresponds to one point away from the right side of the screen. The maximum number of points that can be returned in average mode is 1000 unless ACQUIRE:COUNT has been set to 1.

PEAK Data

Peak detect display mode is used to detect glitches for time base settings of 500 us/div and slower. In this mode, the oscilloscope can sample more data than it can store and display. So, when peak detect is turned on, the oscilloscope scans through the extra data, picks up the minimum and maximum for each time bucket, then stores the data in an array. Each time bucket contains two data sample.

The array is transmitted over the interface bus linearly, starting with time bucket 0 proceeding through time bucket *n*-1, where *n* is the number returned by the :WAVEFORM:POINTS? query (see [page 586](#)). In each time bucket, two values are transmitted, first the minimum, followed by the maximum. The first pair of values corresponds to the time bucket at the leftmost side of the screen. The last pair of values corresponds to the time bucket at the far right side of the screen. In :ACQUIRE:TYPE PEAK mode (see [page 188](#)), the value returned by the :WAVEFORM:XINCREMENT query (see [page 603](#)) should be doubled to find the time difference between the min-max pairs.

HRESolution Data

The high resolution (*smoothing*) mode is used to reduce noise at slower sweep speeds where the digitizer samples faster than needed to fill memory for the displayed time range.

Data Conversion

Word or byte data sent from the oscilloscope must be scaled for useful interpretation. The values used to interpret the data are the X and Y references, X and Y origins, and X and Y increments. These values are read from the waveform preamble. Each channel has its own waveform preamble.

In converting a data value to a voltage value, the following formula is used:

$$\text{voltage} = [(\text{data value} - \text{yreference}) * \text{yincrement}] + \text{yorigin}$$

If the :WAVEform:FORMat data format is ASCII (see [page 585](#)), the data values are converted internally and sent as floating point values separated by commas.

In converting a data value to time, the time value of a data point can be determined by the position of the data point. For example, the fourth data point sent with :WAVEform:XORigin = 16 ns, :WAVEform:XREFerence = 0, and :WAVEform:XINCrement = 2 ns, can be calculated using the following formula:

$$\text{time} = [(\text{data point number} - \text{xreference}) * \text{xincrement}] + \text{xorigin}$$

This would result in the following calculation for time bucket 3:

$$\text{time} = [(3 - 0) * 2 \text{ ns}] + 16 \text{ ns} = 22 \text{ ns}$$

In :ACQUIRE:TYPE PEAK mode (see [page 188](#)), because data is acquired in max-min pairs, modify the previous time formula to the following:

$$\text{time} = [(\text{data pair number} - \text{xreference}) * \text{xincrement} * 2] + \text{xorigin}$$

Data Format for Transfer

There are three formats for transferring waveform data over the interface: BYTE, WORD and ASCII (see ":WAVEform:FORMat" on [page 585](#)). BYTE, WORD and ASCII formatted waveform records are transmitted using the arbitrary block program data format specified in IEEE 488.2.

When you use the block data format, the ASCII character string "#8<DD...D>" is sent prior to sending the actual data. The 8 indicates how many Ds follow. The Ds are ASCII numbers that indicate how many data bytes follow.

For example, if 1000 points will be transferred, and the WORD format was specified, the block header "#800001000" would be sent. The 8 indicates that eight length bytes follow, and 00001000 indicates that 1000 binary data bytes follow.

Use the `:WAVEform:UNSIGNED` command (see [page 601](#)) to control whether data values are sent as unsigned or signed integers. This command can be used to match the instrument's internal data type to the data type used by the programming language. This command has no effect if the data format is ASCII.

Data Format for Transfer - ASCII format

The ASCII format (see `:WAVEform:FORMat` on [page 585](#)) provides access to the waveform data as real Y-axis values without using Y origin, Y reference, and Y increment to convert the binary data. Values are transferred as ASCII digits in floating point format separated by commas. In ASCII format, holes are represented by the value $9.9e+37$. The setting of `:WAVEform:BYTeorder` (see [page 581](#)) and `:WAVEform:UNSIGNED` (see [page 601](#)) have no effect when the format is ASCII.

Data Format for Transfer - WORD format

WORD format (see `:WAVEform:FORMat` on [page 585](#)) provides 16-bit access to the waveform data. In the WORD format, the number of data bytes is twice the number of data points. The number of data points is the value returned by the `:WAVEform:POINts?` query (see [page 586](#)). If the data intrinsically has less than 16 bits of resolution, the data is left-shifted to provide 16 bits of resolution and the least significant bits are set to 0. Currently, the greatest intrinsic resolution of any data is 12 bits, so at least the lowest 4 bits of data will be 0. If there is a hole in the data, the hole is represented by a 16 bit value equal to 0.

Use `:WAVEform:BYTeorder` (see [page 581](#)) to determine if the least significant byte or most significant byte is to be transferred first. The `:BYTeorder` command can be used to alter the transmit sequence to match the storage sequence of an integer in the programming language being used.

Data Format for Transfer - BYTE format

The BYTE format (see `:WAVEform:FORMat` on [page 585](#)) allows 8-bit access to the waveform data. If the data intrinsically has more than 8 bits of resolution (averaged data), the data is right-shifted (truncated) to fit into 8 bits. If there is a hole in the data, the hole is represented by a value of 0. The BYTE-formatted data transfers over the programming interface faster than ASCII or WORD-formatted data, because in ASCII format, as many as 13 bytes per point are transferred, in BYTE format one byte per point is transferred, and in WORD format two bytes per point are transferred.

The `:WAVEform:BYTeorder` command (see [page 581](#)) has no effect when the data format is BYTE.

Digital Channel Data (MSO models only)

The waveform record for digital channels is similar to that of analog channels. The main difference is that the data points represent either DIGital0,...,7 (POD1), DIGital8,...,15 (POD2), or any grouping of digital channels (BUS1 or BUS2).

For digital channels, :WAVeform:UNSigned (see [page 601](#)) must be set to ON.

Digital Channel POD Data Format

Data for digital channels is only available in groups of 8 bits (Pod1 = D0 - D7, Pod2 = D8 - D15). The bytes are organized as:

:WAVeform:SOURce	Bit 7	Bit 6	Bit 5	Bit 4	Bit 3	Bit 2	Bit 1	Bit 0
POD1	D7	D6	D5	D4	D3	D2	D1	D0
POD2	D15	D14	D13	D12	D11	D10	D9	D8

If the :WAVeform:FORMat is WORD (see [page 585](#)) is WORD, every other data byte will be 0. The setting of :WAVeform:BYTeorder (see [page 581](#)) controls which byte is 0.

If a digital channel is not displayed, its bit value in the pod data byte is not defined.

Digital Channel BUS Data Format

Digital channel BUS definitions can include any or all of the digital channels. Therefore, data is always returned as 16-bit values. :BUS commands (see [page 190](#)) are used to select the digital channels for a bus.

Reporting the Setup

The following is a sample response from the :WAVeform? query. In this case, the query was issued following a *RST command.

```
:WAV:UNS 1;VIEW MAIN;BYT MSBF;FORM BYTE;POIN +1000;SOUR CHAN1;SOUR:SUBS
NONE
```

:WAVeform:BYTeorder

C (see [page 740](#))

Command Syntax :WAVeform:BYTeorder <value>
 <value> ::= {LSBFirst | MSBFirst}

The :WAVeform:BYTeorder command sets the output sequence of the WORD data. The parameter MSBFirst sets the most significant byte to be transmitted first. The parameter LSBFirst sets the least significant byte to be transmitted first. This command affects the transmitting sequence only when :WAVeform:FORMat WORD is selected. The default setting is LSBFirst.

Query Syntax :WAVeform:BYTeorder?

The :WAVeform:BYTeorder query returns the current output sequence.

Return Format <value><NL>
 <value> ::= {LSBF | MSBF}

- See Also**
- ["Introduction to :WAVeform Commands"](#) on page 575
 - [":WAVeform:DATA"](#) on page 583
 - [":WAVeform:FORMat"](#) on page 585
 - [":WAVeform:PREamble"](#) on page 590

- Example Code**
- ["Example Code"](#) on page 596
 - ["Example Code"](#) on page 591

:WAVeform:COUNT

C (see [page 740](#))

Query Syntax :WAVeform:COUNT?

The :WAVeform:COUNT? query returns the count used to acquire the current waveform. This may differ from current values if the unit has been stopped and its configuration modified. For all acquisition types except average, this value is 1.

Return Format <count_argument><NL>

<count_argument> ::= an integer from 1 to 65536 in NR1 format

- See Also**
- ["Introduction to :WAVeform Commands"](#) on page 575
 - [":ACQuire:COUNT"](#) on page 177
 - [":ACQuire:TYPE"](#) on page 188

:WAVeform:DATA

C (see [page 740](#))

Query Syntax :WAVeform:DATA?

The :WAVeform:DATA query returns the binary block of sampled data points transmitted using the IEEE 488.2 arbitrary block data format. The binary data is formatted according to the settings of the :WAVeform:UNSigned, :WAVeform:BYTeorder, :WAVeform:FORMat, and :WAVeform:SOURce commands. The number of points returned is controlled by the :WAVeform:POINts command.

In BYTE or WORD waveform formats, these data values have special meaning:

- 0x00 or 0x0000 – Hole. Holes are locations where data has not yet been acquired. Holes can be reasonably expected in the equivalent time acquisition mode (especially at slower horizontal sweep speeds when measuring low frequency signals).

Another situation where there can be zeros in the data, incorrectly, is when programming over telnet port 5024. Port 5024 provides a command prompt and is intended for ASCII transfers. Use telnet port 5025 instead.

- 0x01 or 0x0001 – Clipped low. These are locations where the waveform is clipped at the bottom of the oscilloscope display.
- 0xFF or 0xFFFF – Clipped high. These are locations where the waveform is clipped at the top of the oscilloscope display.

Return Format <binary block data><NL>

- See Also**
- "[Introduction to :WAVeform Commands](#)" on page 575
 - "[:WAVeform:UNSigned](#)" on page 601
 - "[:WAVeform:BYTeorder](#)" on page 581
 - "[:WAVeform:FORMat](#)" on page 585
 - "[:WAVeform:POINts](#)" on page 586
 - "[:WAVeform:PREamble](#)" on page 590
 - "[:WAVeform:SOURce](#)" on page 595
 - "[:WAVeform:TYPE](#)" on page 600

Example Code

```
' QUERY_WAVE_DATA - Outputs waveform data that is stored in a buffer.
' Query the oscilloscope for the waveform data.
myScope.WriteString ":WAV:DATA?"

' READ_WAVE_DATA - The wave data consists of two parts: the header,
' and the actual waveform data followed by a new line (NL) character.
' The query data has the following format:
```

5 Commands by Subsystem

```
'
'   <header><waveform_data><NL>
'
' Where:
'   <header> = #800001000 (This is an example header)
' The "#8" may be stripped off of the header and the remaining
' numbers are the size, in bytes, of the waveform data block. The
' size can vary depending on the number of points acquired for the
' waveform. You can then read that number of bytes from the
' oscilloscope and the terminating NL character.
'
Dim lngI As Long
Dim lngDataValue As Long

varQueryResult = myScope.ReadIEEEBlock(BinaryType_UI1)
' Unsigned integer bytes.
For lngI = 0 To UBound(varQueryResult) _
    Step (UBound(varQueryResult) / 20) ' 20 points.
    If intBytesPerData = 2 Then
        lngDataValue = varQueryResult(lngI) * 256 _
            + varQueryResult(lngI + 1) ' 16-bit value.
    Else
        lngDataValue = varQueryResult(lngI) ' 8-bit value.
    End If
    strOutput = strOutput + "Data point " + _
        CStr(lngI / intBytesPerData) + ", " + _
        FormatNumber((lngDataValue - lngYReference) _
            * sngYIncrement + sngYOrigin) + " V, " + _
        FormatNumber(((lngI / intBytesPerData - lngXReference) _
            * sngXIncrement + dblXOrigin) * 1000000) + " us" + vbCrLf
Next lngI
MsgBox "Waveform data:" + vbCrLf + strOutput
```

Example program from the start: ["VISA COM Example in Visual Basic"](#) on page 828

:WAVeform:FORMat

C (see [page 740](#))

Command Syntax :WAVeform:FORMat <value>
 <value> ::= {WORD | BYTE | ASCii}

The :WAVeform:FORMat command sets the data transmission mode for waveform data points. This command controls how the data is formatted when sent from the oscilloscope.

- ASCii formatted data converts the internal integer data values to real Y-axis values. Values are transferred as ASCii digits in floating point notation, separated by commas.

ASCII formatted data is transferred ASCII text.

- WORD formatted data transfers 16-bit data as two bytes. The :WAVeform:BYTeorder command can be used to specify whether the upper or lower byte is transmitted first. The default (no command sent) is that the upper byte transmitted first.
- BYTE formatted data is transferred as 8-bit bytes.

When the :WAVeform:SOURce is the serial decode bus (SBUS), ASCii is the only waveform format allowed.

When the :WAVeform:SOURce is one of the digital channel buses (BUS1 or BUS2), ASCii and WORD are the only waveform formats allowed.

Query Syntax :WAVeform:FORMat?

The :WAVeform:FORMat query returns the current output format for the transfer of waveform data.

Return Format <value><NL>
 <value> ::= {WORD | BYTE | ASC}

- See Also**
- ["Introduction to :WAVeform Commands"](#) on page 575
 - [":WAVeform:BYTeorder"](#) on page 581
 - [":WAVeform:SOURce"](#) on page 595
 - [":WAVeform:DATA"](#) on page 583
 - [":WAVeform:PREamble"](#) on page 590

Example Code • ["Example Code"](#) on page 596

:WAVeform:POINts

C (see [page 740](#))

Command Syntax :WAVeform:POINts <# points>

```
<# points> ::= {100 | 250 | 500 | 1000 | <points mode>}
              if waveform points mode is NORMAl

<# points> ::= {100 | 250 | 500 | 1000 | 2000 ... 8000000
              in 1-2-5 sequence | <points mode>}
              if waveform points mode is MAXimum or RAW

<points mode> ::= {NORMAl | MAXimum | RAW}
```

NOTE

The <points_mode> option is deprecated. Use the :WAVeform:POINts:MODE command instead.

The :WAVeform:POINts command sets the number of waveform points to be transferred with the :WAVeform:DATA? query. This value represents the points contained in the waveform selected with the :WAVeform:SOURce command.

For the analog or digital sources, there are two different records that can be transferred:

- The first is the raw acquisition record. The maximum number of points available in this record is returned by the :ACQUIRE:POINts? query and may be up to 8,000,000. The raw acquisition record can only be transferred when the oscilloscope is not running and can only be retrieved from the analog or digital sources.
- The second is referred to as the *measurement record* and is a 1000 point (maximum) representation of the raw acquisition record. The measurement record can be retrieved at any time, from any source.

See the :WAVeform:POINts:MODE command (see [page 588](#)) for more information on the <points_mode> option.

Only data visible on the display will be returned.

The maximum number of points returned when the waveform source is math or function is 1000.

When the :WAVeform:SOURce is the serial decode bus (SBUS), this command is ignored, and all available serial decode bus data is returned.

Query Syntax :WAVeform:POINts?

The :WAVeform:POINts query returns the number of waveform points to be transferred when using the :WAVeform:DATA? query. Setting the points mode will affect what data is transferred (see the :WAVeform:POINts:MODE command (see [page 588](#)) for more information).

When the :WAVEform:SOURce is the serial decode bus (SBUS), this query returns the number of messages that were decoded.

Return Format

```
<# points><NL>

<# points> ::= {100 | 250 | 500 | 1000 | <maximum # points>}
              if waveform points mode is NORMAl

<# points> ::= {100 | 250 | 500 | 1000 | 2000 ... 8000000
              in 1-2-5 sequence | <maximum # points>}
              if waveform points mode is MAXimum or RAW
```

NOTE

If a full screen of data is not displayed, the number of points returned will not be 1000 or an even divisor of it.

See Also

- ["Introduction to :WAVEform Commands"](#) on page 575
- [":ACQUIRE:POINTS"](#) on page 180
- [":WAVEform:DATA"](#) on page 583
- [":WAVEform:SOURce"](#) on page 595
- [":WAVEform:VIEW"](#) on page 602
- [":WAVEform:PREAmble"](#) on page 590
- [":WAVEform:POINTS:MODE"](#) on page 588

Example Code

```
' WAVE_POINTS - Specifies the number of points to be transferred
' using the ":WAVEFORM:DATA?" query.
myScope.WriteString ":WAVEFORM:POINTS 1000"
```

Example program from the start: ["VISA COM Example in Visual Basic"](#) on page 828

:WAVeform:POINts:MODE

N (see [page 740](#))

Command Syntax :WAVeform:POINts:MODE <points_mode>

<points_mode> ::= {NORMal | MAXimum | RAW}

The :WAVeform:POINts:MODE command sets the data record to be transferred with the :WAVeform:DATA? query.

For the analog or digital sources, there are two different records that can be transferred:

- The first is the raw acquisition record. The maximum number of points available in this record is returned by the :ACQuire:POINts? query. The raw acquisition record can only be transferred when the oscilloscope is not running and can only be retrieved from the analog or digital sources.
- The second is referred to as the *measurement record* and is a 1000 point (maximum) representation of the raw acquisition record. The measurement record can be retrieved at any time, from any source.

If the <points_mode> is NORMal, the measurement record is retrieved.

If the <points_mode> is RAW, the raw acquisition record is used. Under some conditions, such as when the oscilloscope is running, this data record is unavailable.

If the <points_mode> is MAXimum, whichever record contains the maximum amount of points is used. Usually, this is the raw acquisition record. But, if the raw acquisition record is unavailable (for example, when the oscilloscope is running), or if the reconstruction filter (Sin(x)/x interpolation) is in use, the measurement record may have more data. If data is being retrieved as the oscilloscope is stopped and as the data displayed is changing, the data being retrieved can switch between the measurement and raw acquisition records.

**Considerations
for MAXimum or
RAW data
retrieval**

- The instrument must be stopped (see the :STOP command (see [page 170](#)) or the :DIGitize command (see [page 142](#)) in the root subsystem) in order to return more than 1000 points.
- :TIMEbase:MODE must be set to MAIN.
- :ACQuire:TYPE must be set to NORMal, AVERage, or HRESolution. If AVERage, :ACQuire:COUNT must be set to 1 in order to return more than 1000 points.
- MAXimum or RAW will allow up to 8,000,000 points to be returned. The number of points returned will vary as the instrument's configuration is changed. Use the :WAVeform:POINts? MAXimum query to determine the maximum number of points that can be retrieved at the current settings.

Query Syntax :WAVeform:POINts:MODE?

The :WAVeform:POINts:MODE? query returns the current points mode. Setting the points mode will affect what data is transferred. See the discussion above.

Return Format <points_mode><NL>

<points_mode> ::= {NORMal | MAXimum | RAW}

- See Also**
- ["Introduction to :WAVeform Commands"](#) on page 575
 - [":ACQuire:POINts"](#) on page 180
 - [":WAVeform:DATA"](#) on page 583
 - [":WAVeform:VIEW"](#) on page 602
 - [":WAVeform:PREAmble"](#) on page 590
 - [":WAVeform:POINts"](#) on page 586
 - [":TIMEbase:MODE"](#) on page 444
 - [":ACQuire:TYPE"](#) on page 188
 - [":ACQuire:COUNt"](#) on page 177

:WAVeform:PREamble

C (see page 740)

Query Syntax :WAVeform:PREamble?

The :WAVeform:PREamble query requests the preamble information for the selected waveform source. The preamble data contains information concerning the vertical and horizontal scaling of the data of the corresponding channel.

Return Format <preamble_block><NL>

```
<preamble_block> ::= <format 16-bit NR1>,
                    <type 16-bit NR1>,
                    <points 32-bit NR1>,
                    <count 32-bit NR1>,
                    <xincrement 64-bit floating point NR3>,
                    <xorigin 64-bit floating point NR3>,
                    <xreference 32-bit NR1>,
                    <yincrement 32-bit floating point NR3>,
                    <yorigin 32-bit floating point NR3>,
                    <yreference 32-bit NR1>
```

<format> ::= 0 for BYTE format, 1 for WORD format, 4 for ASCII format;
an integer in NR1 format (format set by :WAVeform:FORMat).

<type> ::= 2 for AVERage type, 0 for NORMal type, 1 for PEAK detect
type; an integer in NR1 format (type set by :ACQuire:TYPE).

<count> ::= Average count or 1 if PEAK or NORMal; an integer in NR1
format (count set by :ACQuire:COUNT).

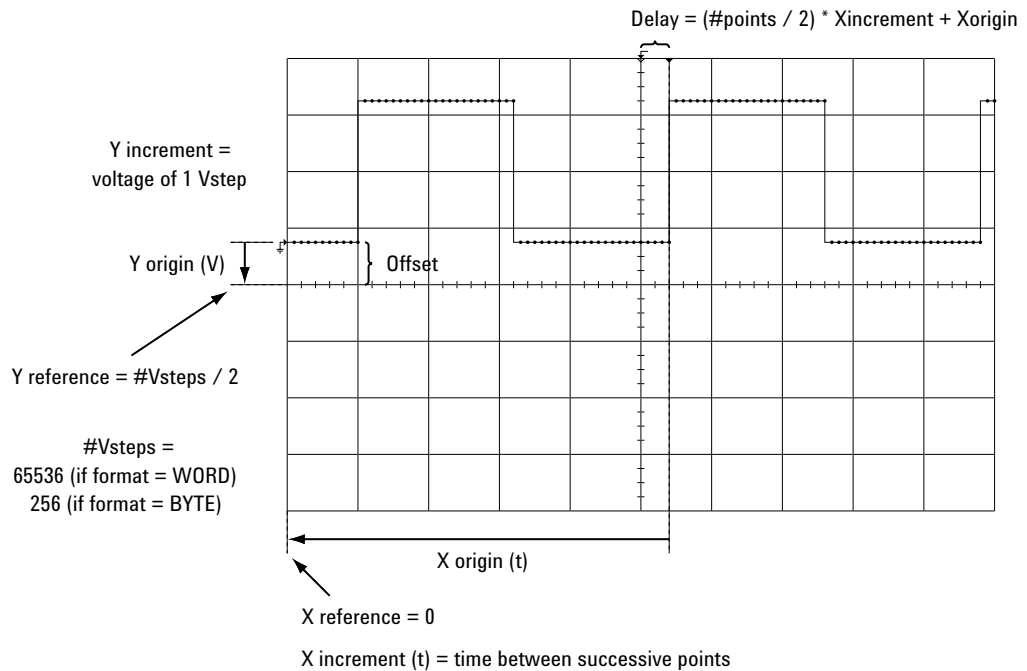

- See Also**
- [":WAVEform COMMANDS"](#) on page 575
 - [":ACQUIRE:COUNT"](#) on page 177
 - [":ACQUIRE:POINTS"](#) on page 180
 - [":ACQUIRE:TYPE"](#) on page 188
 - [":DIGITIZE"](#) on page 142
 - [":WAVEform:COUNT"](#) on page 582
 - [":WAVEform:DATA"](#) on page 583
 - [":WAVEform:FORMat"](#) on page 585
 - [":WAVEform:POINTS"](#) on page 586
 - [":WAVEform:TYPE"](#) on page 600
 - [":WAVEform:XINcrement"](#) on page 603
 - [":WAVEform:XORigin"](#) on page 604
 - [":WAVEform:XREFerence"](#) on page 605
 - [":WAVEform:YINcrement"](#) on page 606
 - [":WAVEform:YORigin"](#) on page 607
 - [":WAVEform:YREFerence"](#) on page 608

Example Code

```
' GET_PREAMBLE - The preamble block contains all of the current
' WAVEFORM settings. It is returned in the form <preamble_block><NL>
' where <preamble_block> is:
'   FORMAT          : int16 - 0 = BYTE, 1 = WORD, 4 = ASCII.
```

5 Commands by Subsystem

```
' TYPE          : int16 - 0 = NORMAL, 1 = PEAK DETECT, 2 = AVERAGE
' POINTS       : int32 - number of data points transferred.
' COUNT        : int32 - 1 and is always 1.
' XINCREMENT   : float64 - time difference between data points.
' XORIGIN      : float64 - always the first data point in memory.
' XREFERENCE   : int32 - specifies the data point associated with
'              x-origin.
' YINCREMENT   : float32 - voltage diff between data points.
' YORIGIN      : float32 - value is the voltage at center screen.
' YREFERENCE   : int32 - specifies the data point where y-origin
'              occurs.
Dim Preamble()
Dim intFormat As Integer
Dim intType As Integer
Dim lngPoints As Long
Dim lngCount As Long
Dim dblXIncrement As Double
Dim dblXOrigin As Double
Dim lngXReference As Long
Dim sngYIncrement As Single
Dim sngYOrigin As Single
Dim lngYReference As Long
Dim strOutput As String

myScope.WriteString ":WAVEFORM:PREAMBLE?" ' Query for the preamble.
Preamble() = myScope.ReadList ' Read preamble information.
intFormat = Preamble(0)
intType = Preamble(1)
lngPoints = Preamble(2)
lngCount = Preamble(3)
dblXIncrement = Preamble(4)
dblXOrigin = Preamble(5)
lngXReference = Preamble(6)
sngYIncrement = Preamble(7)
sngYOrigin = Preamble(8)
lngYReference = Preamble(9)
```

Example program from the start: ["VISA COM Example in Visual Basic"](#) on page 828

:WAVeform:SEGMented:COUNT

N (see [page 740](#))

Query Syntax :WAVeform:SEGMented:COUNT?

NOTE

This command is available when the segmented memory option (Option SGM) is enabled.

The :WAVeform:SEGMented:COUNT query returns the number of memory segments in the acquired data. You can use the :WAVeform:SEGMented:COUNT? query while segments are being acquired (although :DIGitize blocks subsequent queries until the full segmented acquisition is complete).

The segmented memory acquisition mode is enabled with the :ACQUIRE:MODE command. The number of segments to acquire is set using the :ACQUIRE:SEGMented:COUNT command, and data is acquired using the :DIGitize, :SINGLE, or :RUN commands.

Return Format <count> ::= an integer from 2 to 2000 in NR1 format (count set by :ACQUIRE:SEGMented:COUNT).

- See Also**
- [":ACQUIRE:MODE"](#) on page 179
 - [":ACQUIRE:SEGMented:COUNT"](#) on page 183
 - [":DIGitize"](#) on page 142
 - [":SINGLE"](#) on page 168
 - [":RUN"](#) on page 166
 - ["Introduction to :WAVeform Commands"](#) on page 575

Example Code • ["Example Code"](#) on page 184

:WAVeform:SEGmented:TTAG

N (see [page 740](#))

Query Syntax :WAVeform:SEGmented:TTAG?

NOTE

This command is available when the segmented memory option (Option SGM) is enabled.

The :WAVeform:SEGmented:TTAG? query returns the time tag of the currently selected segmented memory index. The index is selected using the :ACQUIRE:SEGmented:INDEX command.

Return Format <time_tag> ::= in NR3 format

- See Also**
- [":ACQUIRE:SEGmented:INDEX"](#) on page 184
 - ["Introduction to :WAVeform Commands"](#) on page 575

Example Code

- ["Example Code"](#) on page 184

:WAVeform:SOURce

C (see [page 740](#))

Command Syntax :WAVeform:SOURce <source>

<source> ::= {CHANnel<n> | FUNCTION | MATH | SBUS} for DSO models

<source> ::= {CHANnel<n> | POD{1 | 2} | BUS{1 | 2} | FUNCTION
| MATH | SBUS} for MSO models

<n> ::= {1 | 2 | 3 | 4} for the four channel oscilloscope models

<n> ::= {1 | 2} for the two channel oscilloscope models

The :WAVeform:SOURce command selects the analog channel, function, digital pod, digital bus, or serial decode bus to be used as the source for the :WAVeform commands.

Function capabilities include add, subtract, multiply; integrate, differentiate, and FFT (Fast Fourier Transform) operations.

When the :WAVeform:SOURce is the serial decode bus (SBUS), ASCii is the only waveform format allowed.

With MSO oscilloscope models, you can choose a POD or BUS as the waveform source. There are some differences between POD and BUS when formatting and getting data from the oscilloscope:

- When POD1 or POD2 is selected as the waveform source, you can choose the BYTE, WORD, or ASCii formats (see [":WAVeform:FORMat"](#) on [page 585](#)).

When the WORD format is chosen, every other data byte will be 0. The setting of :WAVeform:BYTeorder controls which byte is 0.

When the ASCii format is chosen, the :WAVeform:DATA? query returns a string with unsigned decimal values separated by commas.

- When BUS1 or BUS2 is selected as the waveform source, you can choose the WORD or ASCii formats (but not BYTE because bus values are always returned as 16-bit values).

When the ASCii format is chosen, the :WAVeform:DATA? query returns a string with timestamps and hexadecimal bus values, for example:
-5.000000000000e-08,0x1938,-4.990000000000e-08,0xff38,...

Query Syntax :WAVeform:SOURce?

The :WAVeform:SOURce? query returns the currently selected source for the WAVeform commands.

NOTE

MATH is an alias for FUNCTION. The :WAVeform:SOURce? Query returns FUNC if the source is FUNCTION or MATH.

Return Format

```
<source><NL>
<source> ::= {CHAN<n> | FUNC | SBUS} for DSO models
<source> ::= {CHAN<n> | POD{1 | 2} | BUS{1 | 2} | FUNC | SBUS}
              for MSO models
<n> ::= {1 | 2 | 3 | 4} for the four channel oscilloscope models
<n> ::= {1 | 2} for the two channel oscilloscope models
```

- See Also**
- ["Introduction to :WAVEform Commands" on page 575](#)
 - [":DIGitize" on page 142](#)
 - [":WAVEform:FORMat" on page 585](#)
 - [":WAVEform:BYTeorder" on page 581](#)
 - [":WAVEform:DATA" on page 583](#)
 - [":WAVEform:PREamble" on page 590](#)

Example Code

```
' WAVEFORM_DATA - To obtain waveform data, you must specify the
' WAVEFORM parameters for the waveform data prior to sending the
' ":WAVEFORM:DATA?" query. Once these parameters have been sent,
' the waveform data and the preamble can be read.
'
' WAVE_SOURCE - Selects the channel to be used as the source for
' the waveform commands.
myScope.WriteString ":WAVEFORM:SOURCE CHAN1"

' WAVE_POINTS - Specifies the number of points to be transferred
' using the ":WAVEFORM:DATA?" query.
myScope.WriteString ":WAVEFORM:POINTS 1000"

' WAVE_FORMAT - Sets the data transmission mode for the waveform
' data output. This command controls whether data is formatted in
' a word or byte format when sent from the oscilloscope.
Dim lngVSteps As Long
Dim intBytesPerData As Integer

' Data in range 0 to 65535.
myScope.WriteString ":WAVEFORM:FORMAT WORD"
lngVSteps = 65536
intBytesPerData = 2

' Data in range 0 to 255.
myScope.WriteString ":WAVEFORM:FORMAT BYTE"
lngVSteps = 256
intBytesPerData = 1

' GET_PREAMBLE - The preamble block contains all of the current
' WAVEFORM settings. It is returned in the form <preamble_block><NL>
' where <preamble_block> is:
'   FORMAT      : int16 - 0 = BYTE, 1 = WORD, 2 = ASCII.
'   TYPE        : int16 - 0 = NORMAL, 1 = PEAK DETECT, 2 = AVERAGE
'   POINTS      : int32 - number of data points transferred.
'   COUNT       : int32 - 1 and is always 1.
'   XINCREMENT  : float64 - time difference between data points.
```

```

'   XORIGIN      : float64 - always the first data point in memory.
'   XREFERENCE   : int32 - specifies the data point associated with
'                   x-origin.
'   YINCREMENT   : float32 - voltage diff between data points.
'   YORIGIN      : float32 - value is the voltage at center screen.
'   YREFERENCE   : int32 - specifies the data point where y-origin
'                   occurs.
Dim Preamble()
Dim intFormat As Integer
Dim intType As Integer
Dim lngPoints As Long
Dim lngCount As Long
Dim dblXIncrement As Double
Dim dblXOrigin As Double
Dim lngXReference As Long
Dim sngYIncrement As Single
Dim sngYOrigin As Single
Dim lngYReference As Long
Dim strOutput As String

myScope.WriteString ":WAVEFORM:PREAMBLE?" ' Query for the preamble.
Preamble() = myScope.ReadList ' Read preamble information.
intFormat = Preamble(0)
intType = Preamble(1)
lngPoints = Preamble(2)
lngCount = Preamble(3)
dblXIncrement = Preamble(4)
dblXOrigin = Preamble(5)
lngXReference = Preamble(6)
sngYIncrement = Preamble(7)
sngYOrigin = Preamble(8)
lngYReference = Preamble(9)
strOutput = ""
'strOutput = strOutput + "Format = " + CStr(intFormat) + vbCrLf
'strOutput = strOutput + "Type = " + CStr(intType) + vbCrLf
'strOutput = strOutput + "Points = " + CStr(lngPoints) + vbCrLf
'strOutput = strOutput + "Count = " + CStr(lngCount) + vbCrLf
'strOutput = strOutput + "X increment = " + _
'   FormatNumber(dblXIncrement * 1000000) + " us" + vbCrLf
'strOutput = strOutput + "X origin = " + _
'   FormatNumber(dblXOrigin * 1000000) + " us" + vbCrLf
'strOutput = strOutput + "X reference = " + _
'   CStr(lngXReference) + vbCrLf
'strOutput = strOutput + "Y increment = " + _
'   FormatNumber(sngYIncrement * 1000) + " mV" + vbCrLf
'strOutput = strOutput + "Y origin = " + _
'   FormatNumber(sngYOrigin) + " V" + vbCrLf
'strOutput = strOutput + "Y reference = " + _
'   CStr(lngYReference) + vbCrLf
strOutput = strOutput + "Volts/Div = " + _
'   FormatNumber(lngVSteps * sngYIncrement / 8) + _
'   " V" + vbCrLf
strOutput = strOutput + "Offset = " + _
'   FormatNumber((lngVSteps / 2 - lngYReference) * _
'   sngYIncrement + sngYOrigin) + " V" + vbCrLf
strOutput = strOutput + "Sec/Div = " + _
'   FormatNumber(lngPoints * dblXIncrement / 10 * _

```

5 Commands by Subsystem

```
1000000) + " us" + vbCrLf
strOutput = strOutput + "Delay = " + _
    FormatNumber(((lngPoints / 2 - lngXReference) * _
        dblXIncrement + dblXOrigin) * 1000000) + " us" + vbCrLf

' QUERY_WAVE_DATA - Outputs waveform data that is stored in a buffer.

' Query the oscilloscope for the waveform data.
myScope.WriteString ":WAV:DATA?"

' READ_WAVE_DATA - The wave data consists of two parts: the header,
' and the actual waveform data followed by a new line (NL) character.
' The query data has the following format:
'
' <header><waveform_data><NL>
'
' Where:
' <header> = #800001000 (This is an example header)
' The "#8" may be stripped off of the header and the remaining
' numbers are the size, in bytes, of the waveform data block. The
' size can vary depending on the number of points acquired for the
' waveform. You can then read that number of bytes from the
' oscilloscope and the terminating NL character.
'
Dim lngI As Long
Dim lngDataValue As Long

' Unsigned integer bytes.
varQueryResult = myScope.ReadIEEEBlock(BinaryType_UI1)

For lngI = 0 To UBound(varQueryResult) _
    Step (UBound(varQueryResult) / 20) ' 20 points.
    If intBytesPerData = 2 Then
        lngDataValue = varQueryResult(lngI) * 256 _
            + varQueryResult(lngI + 1) ' 16-bit value.
    Else
        lngDataValue = varQueryResult(lngI) ' 8-bit value.
    End If
    strOutput = strOutput + "Data point " + _
        CStr(lngI / intBytesPerData) + ", " + _
        FormatNumber((lngDataValue - lngYReference) _
            * sngYIncrement + sngYOrigin) + " V, " + _
        FormatNumber(((lngI / intBytesPerData - lngXReference) _
            * sngXIncrement + dblXOrigin) * 1000000) + " us" + vbCrLf
Next lngI
MsgBox "Waveform data:" + vbCrLf + strOutput
```

Example program from the start: ["VISA COM Example in Visual Basic"](#) on page 828

:WAVeform:SOURce:SUBSource

C (see [page 740](#))

Command Syntax :WAVeform:SOURce:SUBSource <subsource>

<subsource> ::= {{NONE | RX} | TX}

If the :WAVeform:SOURce is SBUS (serial decode), more than one data set may be available, and this command lets you choose from the available data sets.

Currently, only UART serial decode lets you get "TX" data. The default, NONE, specifies "RX" data. (RX is an alias for NONE.)

If the :WAVeform:SOURce is not SBUS, or the :SBUS:MODE is not UART, the only valid subsource is NONE.

Query Syntax :WAVeform:SOURce:SUBSource?

The :WAVeform:SOURce:SUBSource? query returns the current waveform subsource setting.

Return Format <subsource><NL>

<subsource> ::= {NONE | TX}

- See Also**
- ["Introduction to :WAVeform Commands"](#) on page 575
 - [":WAVeform:SOURce"](#) on page 595

:WAVeform:TYPE

C (see [page 740](#))

Query Syntax :WAVeform:TYPE?

The :WAVeform:TYPE? query returns the acquisition mode associated with the currently selected waveform. The acquisition mode is set by the :ACQUIRE:TYPE command.

Return Format <mode><NL>

<mode> ::= {NORM | PEAK | AVER | HRES}

NOTE

If the :WAVeform:SOURce is POD1, POD2, or SBUS, the type is always NORM.

-
- See Also**
- ["Introduction to :WAVeform Commands"](#) on page 575
 - [":ACQUIRE:TYPE"](#) on page 188
 - [":WAVeform:DATA"](#) on page 583
 - [":WAVeform:PREamble"](#) on page 590
 - [":WAVeform:SOURce"](#) on page 595

:WAVeform:UNSigned

C (see [page 740](#))

Command Syntax :WAVeform:UNSigned <unsigned>
 <unsigned> ::= {{0 | OFF} | {1 | ON}}

The :WAVeform:UNSigned command turns unsigned mode on or off for the currently selected waveform. Use the WAVeform:UNSigned command to control whether data values are sent as unsigned or signed integers. This command can be used to match the instrument's internal data type to the data type used by the programming language. This command has no effect if the data format is ASCII.

If :WAVeform:SOURce is set to POD1 or POD2, WAVeform:UNSigned must be set to ON.

Query Syntax :WAVeform:UNSigned?

The :WAVeform:UNSigned? query returns the status of unsigned mode for the currently selected waveform.

Return Format <unsigned><NL>
 <unsigned> ::= {0 | 1}

- See Also**
- ["Introduction to :WAVeform Commands"](#) on page 575
 - [":WAVeform:SOURce"](#) on page 595

:WAVeform:VIEW

C (see [page 740](#))

Command Syntax :WAVeform:VIEW <view>
<view> ::= {MAIN}

The :WAVeform:VIEW command sets the view setting associated with the currently selected waveform. Currently, the only legal value for the view setting is MAIN.

Query Syntax :WAVeform:VIEW?

The :WAVeform:VIEW? query returns the view setting associated with the currently selected waveform.

Return Format <view><NL>
<view> ::= {MAIN}

- See Also**
- "[Introduction to :WAVeform Commands](#)" on page 575
 - "[:WAVeform:POINTs](#)" on page 586

:WAVeform:XINCrement**C** (see [page 740](#))**Query Syntax** :WAVeform:XINCrement?

The :WAVeform:XINCrement? query returns the x-increment value for the currently specified source. This value is the time difference between consecutive data points in seconds.

Return Format <value><NL>

<value> ::= x-increment in the current preamble in 64-bit floating point NR3 format

- See Also**
- "[Introduction to :WAVeform Commands](#)" on page 575
 - "[:WAVeform:PREamble](#)" on page 590

Example Code

- "[Example Code](#)" on page 591

:WAVeform:XORigin

C (see [page 740](#))

Query Syntax :WAVeform:XORigin?

The :WAVeform:XORigin? query returns the x-origin value for the currently specified source. XORigin is the X-axis value of the data point specified by the :WAVeform:XREFerence value. In this product, that is always the X-axis value of the first data point (XREFerence = 0).

Return Format <value><NL>

<value> ::= x-origin value in the current preamble in 64-bit floating point NR3 format

- See Also**
- ["Introduction to :WAVeform Commands"](#) on page 575
 - [":WAVeform:PREamble"](#) on page 590
 - [":WAVeform:XREFerence"](#) on page 605

- Example Code**
- ["Example Code"](#) on page 591

:WAVeform:XREFerence

C (see [page 740](#))

Query Syntax :WAVeform:XREFerence?

The :WAVeform:XREFerence? query returns the x-reference value for the currently specified source. This value specifies the index of the data point associated with the x-origin data value. In this product, the x-reference point is the first point displayed and XREFerence is always 0.

Return Format <value><NL>

<value> ::= x-reference value = 0 in 32-bit NR1 format

- See Also**
- "[Introduction to :WAVeform Commands](#)" on page 575
 - "[:WAVeform:PREamble](#)" on page 590
 - "[:WAVeform:XORigin](#)" on page 604

Example Code • "[Example Code](#)" on page 591

:WAVeform:YINCrement

C (see [page 740](#))

Query Syntax :WAVeform:YINCrement?

The :WAVeform:YINCrement? query returns the y-increment value in volts for the currently specified source. This value is the voltage difference between consecutive data values. The y-increment for digital waveforms is always "1".

Return Format <value><NL>

<value> ::= y-increment value in the current preamble in 32-bit floating point NR3 format

- See Also**
- ["Introduction to :WAVeform Commands"](#) on page 575
 - [":WAVeform:PREamble"](#) on page 590

- Example Code**
- ["Example Code"](#) on page 591

:WAVeform:YORigin

C (see [page 740](#))

Query Syntax :WAVeform:YORigin?

The :WAVeform:YORigin? query returns the y-origin value for the currently specified source. This value is the Y-axis value of the data value specified by the :WAVeform:YREFerence value. For this product, this is the Y-axis value of the center of the screen.

Return Format <value><NL>

<value> ::= y-origin in the current preamble in 32-bit floating point NR3 format

- See Also**
- "[Introduction to :WAVeform Commands](#)" on [page 575](#)
 - "[:WAVeform:PREamble](#)" on [page 590](#)
 - "[:WAVeform:YREFerence](#)" on [page 608](#)

- Example Code**
- "[Example Code](#)" on [page 591](#)

:WAVeform:YREFerence

C (see [page 740](#))

Query Syntax :WAVeform:YREFerence?

The :WAVeform:YREFerence? query returns the y-reference value for the currently specified source. This value specifies the data point value where the y-origin occurs. In this product, this is the data point value of the center of the screen. It is undefined if the format is ASCii.

Return Format <value><NL>

<value> ::= y-reference value in the current preamble in 32-bit NR1 format

- See Also**
- ["Introduction to :WAVeform Commands"](#) on page 575
 - [":WAVeform:PREamble"](#) on page 590
 - [":WAVeform:YORigin"](#) on page 607

- Example Code**
- ["Example Code"](#) on page 591

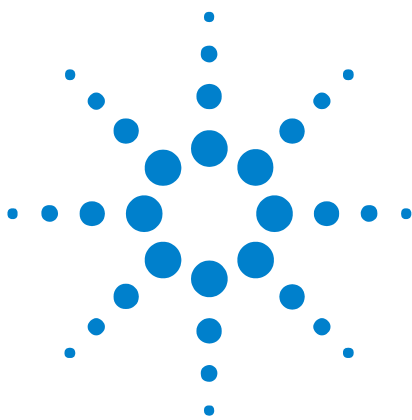

6 Commands A-Z

A	609
B	610
C	611
D	614
E	615
F	616
G	618
H	618
I	619
L	619
M	620
N	623
O	624
P	624
Q	626
R	626
S	627
T	632
U	637
V	637
W	638
X	639
Y	639

- A**
- AALias, `":ACquire:AALias"` on page 175
 - ACKnowledge, `":TRIGger:CAN:ACKnowledge"` on page 691
 - `":ACquire:AALias"` on page 175
 - `":ACquire:COMplete"` on page 176
 - `":ACquire:COUNt"` on page 177
 - `":ACquire:DAALias"` on page 178



- [":ACQUIRE:MODE"](#) on page 179
- [":ACQUIRE:POINTS"](#) on page 180
- [":ACQUIRE:RSIGNAL"](#) on page 181
- [":ACQUIRE:SEGMENTED:ANALYZE"](#) on page 182
- [":ACQUIRE:SEGMENTED:COUNT"](#) on page 183
- [":ACQUIRE:SEGMENTED:INDEX"](#) on page 184
- [":ACQUIRE:SRATE"](#) on page 187
- [":ACQUIRE:TYPE"](#) on page 188
- [":ACTIVITY"](#) on page 134
- ADDRESS Commands:
 - [":SBUS:BUSDOCTOR:ADDRESS"](#) on page 409
 - [":TRIGGER:IIC:PATTERN:ADDRESS"](#) on page 514
- [":AER \(Arm Event Register\)"](#) on page 135
- AMASK Commands:
 - [":MTEST:AMASK:CREATE"](#) on page 351
 - [":MTEST:AMASK:{SAVE | STORE}"](#) on page 680
 - [":MTEST:AMASK:SOURCE"](#) on page 352
 - [":MTEST:AMASK:UNITS"](#) on page 353
 - [":MTEST:AMASK:XDELTA"](#) on page 354
 - [":MTEST:AMASK:YDELTA"](#) on page 355
- ANALYZE, [":ACQUIRE:SEGMENTED:ANALYZE"](#) on page 182
- APRINTER, [":HARDCOPY:APRINTER"](#) on page 275
- AREA Commands:
 - [":HARDCOPY:AREA"](#) on page 274
 - [":SAVE:IMAGE:AREA"](#) on page 394
- ASIZE, [":SBUS:IIC:ASIZE"](#) on page 423
- [":AUTOSCALE"](#) on page 136
 - [":AUTOSCALE:AMODE"](#) on page 138
 - [":AUTOSCALE:CHANNELS"](#) on page 139
- AVERAGE Commands:
 - [":MTEST:AVERAGE"](#) on page 681
 - [":MTEST:AVERAGE:COUNT"](#) on page 682
- B** • BASE Commands:
 - [":SBUS:UART:BASE"](#) on page 427
 - [":TRIGGER:UART:BASE"](#) on page 555

- BAUDrate Commands:
 - [":SBUS:BUSDoctor:BAUDrate"](#) on page 410
 - [":TRIGger:CAN:SIGNal:BAUDrate"](#) on page 472
 - [":TRIGger:LIN:SIGNal:BAUDrate"](#) on page 525
 - [":TRIGger:UART:BAUDrate"](#) on page 556
- BIND, [":MTESt:SCALe:BIND"](#) on page 372
- BIT<m>, [":BUS<n>:BIT<m>"](#) on page 192
- BITorder, [":TRIGger:UART:BITorder"](#) on page 557
- BITS, [":BUS<n>:BITS"](#) on page 193
- [":BLANK"](#) on page 140
- BURSt, [":TRIGger:UART:BURSt"](#) on page 558
- [":BUS<n>:BIT<m>"](#) on page 192
- [":BUS<n>:BITS"](#) on page 193
- [":BUS<n>:CLEar"](#) on page 195
- [":BUS<n>:DISPlay"](#) on page 196
- [":BUS<n>:LABel"](#) on page 197
- [":BUS<n>:MASK"](#) on page 198
- BUSDoctor Commands:
 - [":SBUS:BUSDoctor:ADDResS"](#) on page 409
 - [":SBUS:BUSDoctor:BAUDrate"](#) on page 410
 - [":SBUS:BUSDoctor:CHANnel"](#) on page 411
 - [":SBUS:BUSDoctor:MODE"](#) on page 412
- BWLimit Commands:
 - [":CHANnel<n>:BWLimit"](#) on page 212
 - [":EXTernal:BWLimit"](#) on page 247
- BYTeorder, [":WAVEform:BYTeorder"](#) on page 581
- C**
 - [":CALibrate:DATE"](#) on page 201
 - [":CALibrate:LABel"](#) on page 202
 - [":CALibrate:OUTPut"](#) on page 203
 - [":CALibrate:STARt"](#) on page 204
 - [":CALibrate:STATus"](#) on page 205
 - [":CALibrate:SWITCh"](#) on page 206
 - [":CALibrate:TEMPerature"](#) on page 207
 - [":CALibrate:TIME"](#) on page 208
 - CAN Commands:

- [":SBUS:CAN:COUNt:ERRor"](#) on page 413
- [":SBUS:CAN:COUNt:OVERload"](#) on page 414
- [":SBUS:CAN:COUNt:RESet"](#) on page 415
- [":SBUS:CAN:COUNt:TOTal"](#) on page 416
- [":SBUS:CAN:COUNt:UTILization"](#) on page 417
- [":TRIGger:CAN Commands"](#) on page 465
- [CBASe, ":TRIGger:FLEXray:TIME:CBASe"](#) on page 499
- [CCBASe, ":TRIGger:FLEXray:FRAME:CCBase"](#) on page 495
- [CCRepetition, ":TRIGger:FLEXray:FRAME:CCRepetition"](#) on page 496
- [CRepetition, ":TRIGger:FLEXray:TIME:CREPetition"](#) on page 500
- [":CDISplay"](#) on page 141
- [CENTer, ":FUNCTion:CENTer"](#) on page 258
- [CHANnel, ":SBUS:BUSDoctor:CHANnel"](#) on page 411
- [":CHANnel:ACTivity"](#) on page 646
- [":CHANnel:LABEL"](#) on page 647
- [":CHANnel:THReshold"](#) on page 648
- [":CHANnel2:SKEW"](#) on page 649
- [":CHANnel<n>:BWLimit"](#) on page 212
- [":CHANnel<n>:COUPling"](#) on page 213
- [":CHANnel<n>:DISPlay"](#) on page 214
- [":CHANnel<n>:IMPedance"](#) on page 215
- [":CHANnel<n>:INPut"](#) on page 650
- [":CHANnel<n>:INVert"](#) on page 216
- [":CHANnel<n>:LABel"](#) on page 217
- [":CHANnel<n>:OFFSet"](#) on page 218
- [":CHANnel<n>:PMODE"](#) on page 651
- [":CHANnel<n>:PROBe"](#) on page 219
- [":CHANnel<n>:PROBe.ID"](#) on page 220
- [":CHANnel<n>:PROBe:SKEW"](#) on page 221
- [":CHANnel<n>:PROBe:STYPe"](#) on page 222
- [":CHANnel<n>:PROTection"](#) on page 223
- [":CHANnel<n>:RANGe"](#) on page 224
- [":CHANnel<n>:SCALe"](#) on page 225
- [":CHANnel<n>:UNITs"](#) on page 226
- [":CHANnel<n>:VERNier"](#) on page 227

- **CLear Commands:**
 - [":BUS<n>:CLEar"](#) on page 195
 - [":DISPlay:CLEar"](#) on page 237
 - [":MEASure:CLEar"](#) on page 302
- **CLOCK Commands:**
 - [":TRIGger:IIC\[:SOURce\]:CLOCK"](#) on page 517
 - [":TRIGger:SPI:CLOCK:SLOPe"](#) on page 539
 - [":TRIGger:SPI:CLOCK:TIMEout"](#) on page 540
 - [":TRIGger:SPI:SOURce:CLOCK"](#) on page 544
- ["*CLS \(Clear Status\)"](#) on page 109
- **COMplete**, [":ACQuire:COMplete"](#) on page 176
- **CONDition**, [":HWERegister:CONDition \(Hardware Event Condition Register\)"](#) on page 146
- **CONNect**, [":DISPlay:CONNect"](#) on page 652
- **COUNT Commands:**
 - [":ACQuire:COUNT"](#) on page 177
 - [":ACQuire:SEGmented:COUNT"](#) on page 183
 - [":MTESt:AVERage:COUNT"](#) on page 682
 - [":MTESt:COUNT:FWAVeforms"](#) on page 356
 - [":MTESt:COUNT:RESet"](#) on page 357
 - [":MTESt:COUNT:TIME"](#) on page 358
 - [":MTESt:COUNT:WAVeforms"](#) on page 359
 - [":SBUS:CAN:COUNT:ERRor"](#) on page 413
 - [":SBUS:CAN:COUNT:OVERload"](#) on page 414
 - [":SBUS:CAN:COUNT:RESet"](#) on page 415
 - [":SBUS:CAN:COUNT:TOTal"](#) on page 416
 - [":SBUS:CAN:COUNT:UTILization"](#) on page 417
 - [":SBUS:FLEXray:COUNT:NULL"](#) on page 419
 - [":SBUS:FLEXray:COUNT:RESet"](#) on page 420
 - [":SBUS:FLEXray:COUNT:SYNC"](#) on page 421
 - [":SBUS:FLEXray:COUNT:TOTal"](#) on page 422
 - [":SBUS:UART:COUNT:ERRor"](#) on page 428
 - [":SBUS:UART:COUNT:RESet"](#) on page 429
 - [":SBUS:UART:COUNT:RXFRames"](#) on page 430
 - [":SBUS:UART:COUNT:TXFRames"](#) on page 431

- ":TRIGger:EBURst:COUNt" on page 483
- ":WAVeform:COUNt" on page 582
- ":WAVeform:SEGMENTed:COUNt" on page 593
- COUNter, ":MEASure:COUNter" on page 303
- COUPLing Commands:
 - ":CHANnel<n>:COUPLing" on page 213
 - ":TRIGger[:EDGE]:COUPLing" on page 487
- CREate, ":MTEST:AMASK:CREate" on page 351
- D**
 - DAALias, ":ACQuire:DAALias" on page 178
 - DATA Commands:
 - ":DISPlay:DATA" on page 238
 - ":MTEST:DATA" on page 360
 - ":TRIGger:CAN:PATtern:DATA" on page 467
 - ":TRIGger:CAN:PATtern:DATA:LENGth" on page 468
 - ":TRIGger:IIC:PATtern:DATA" on page 515
 - ":TRIGger:IIC:PATtern:DATA2" on page 516
 - ":TRIGger:IIC[:SOURce]:DATA" on page 518
 - ":TRIGger:SPI:PATtern:DATA" on page 542
 - ":TRIGger:SPI:SOURce:DATA" on page 545
 - ":TRIGger:UART:DATA" on page 559
 - ":WAVeform:DATA" on page 583
 - DATE Commands:
 - ":CALibrate:DATE" on page 201
 - ":SYSTem:DATE" on page 434
 - DEFine, ":MEASure:DEFine" on page 304
 - DEFinition Commands:
 - ":TRIGger:CAN:SIGNal:DEFinition" on page 692
 - ":TRIGger:LIN:SIGNal:DEFinition" on page 693
 - DELay Commands:
 - ":MEASure:DELay" on page 307
 - ":TIMEbase:DELay" on page 690
 - DELete, ":MTEST:DELete" on page 361
 - DESTination, ":HARDcopy:DESTination" on page 659
 - DEVice, ":HARDcopy:DEVice" on page 660
 - ":DIGital<n>:DISPlay" on page 230

- ":DIGital<n>:LABel" on page 231
- ":DIGital<n>:POSition" on page 232
- ":DIGital<n>:SIZE" on page 233
- ":DIGital<n>:THReshold" on page 234
- ":DIGitize" on page 142
- DISPlay Commands:
 - ":BUS<n>:DISPlay" on page 196
 - ":CHANnel<n>:DISPlay" on page 214
 - ":DIGital<n>:DISPlay" on page 230
 - ":FUNction:DISPlay" on page 259
 - ":POD<n>:DISPlay" on page 380
 - ":SBUS:DISPlay" on page 418
- ":DISPlay:CLEar" on page 237
- ":DISPlay:CONNect" on page 652
- ":DISPlay:DATA" on page 238
- ":DISPlay:LABel" on page 240
- ":DISPlay:LABList" on page 241
- ":DISPlay:ORDer" on page 653
- ":DISPlay:PERsistence" on page 242
- ":DISPlay:SOURce" on page 243
- ":DISPlay:VECTors" on page 244
- DMINus, ":TRIGger:USB:SOURce:DMINus" on page 569
- DPLus, ":TRIGger:USB:SOURce:DPLus" on page 570
- DSP, ":SYSTem:DSP" on page 435
- DURation, ":TRIGger:DURation Commands" on page 476
- DUTYcycle, ":MEASure:DUTYcycle" on page 309
- E**
 - EBURst, ":TRIGger:EBURst Commands" on page 482
 - EDGE, ":TRIGger[:EDGE] Commands" on page 486
 - ENABLE":MTEST:ENABLE" on page 362
 - ":ERASE" on page 654
 - ERRor Commands:
 - ":SBUS:CAN:COUNT:ERRor" on page 413
 - ":SBUS:UART:COUNT:ERRor" on page 428
 - ":SYSTem:ERRor" on page 436
 - ":TRIGger:FLEXray:ERRor:TYPE" on page 493

- ["*ESE \(Standard Event Status Enable\)"](#) on page 110
 - ["*ESR \(Standard Event Status Register\)"](#) on page 112
 - EVENT Commands:
 - [":HWERegister\[:EVENT\] \(Hardware Event Event Register\)"](#) on page 148
 - [":MTERegister\[:EVENT\] \(Mask Test Event Event Register\)"](#) on page 153
 - [":EXTernal:BWLimit"](#) on page 247
 - [":EXTernal:IMPedance"](#) on page 248
 - [":EXTernal:INPut"](#) on page 655
 - [":EXTernal:PMODE"](#) on page 656
 - [":EXTernal:PROBE"](#) on page 249
 - [":EXTernal:PROBE:ID"](#) on page 250
 - [":EXTernal:PROBE:STYPe"](#) on page 251
 - [":EXTernal:PROTection"](#) on page 252
 - [":EXTernal:RANGe"](#) on page 253
 - [":EXTernal:UNITs"](#) on page 254
- F**
- FACTion Commands:
 - [":MTESt:RMODE:FACTion:PRINT"](#) on page 366
 - [":MTESt:RMODE:FACTion:SAVE"](#) on page 367
 - [":MTESt:RMODE:FACTion:STOP"](#) on page 368
 - FACTors Commands:
 - [":HARDcopy:FACTors"](#) on page 276
 - [":SAVE:IMAGE:FACTors"](#) on page 395
 - FALLtime, [":MEASure:FALLtime"](#) on page 310
 - FFEed, [":HARDcopy:FFEed"](#) on page 277
 - FILEname Commands:
 - [":HARDcopy:FILEname"](#) on page 661
 - [":RECall:FILEname"](#) on page 385
 - [":SAVE:FILEname"](#) on page 392
 - FIND, [":TRIGger:SEQuence:FIND"](#) on page 533
 - FLEXray Commands:
 - [":SBUS:FLEXray:COUNt:NULL"](#) on page 419
 - [":SBUS:FLEXray:COUNt:RESet"](#) on page 420
 - [":SBUS:FLEXray:COUNt:SYNC"](#) on page 421
 - [":SBUS:FLEXray:COUNt:TOTal"](#) on page 422

- ":TRIGger:FLEXray:ERRor:TYPE" on page 493
- ":TRIGger:FLEXray:FRAMe:CCBase" on page 495
- ":TRIGger:FLEXray:FRAMe:CCRepetition" on page 496
- ":TRIGger:FLEXray:FRAMe:ID" on page 497
- ":TRIGger:FLEXray:FRAMe:TYPE" on page 498
- ":TRIGger:FLEXray:TIME:CBASe" on page 499
- ":TRIGger:FLEXray:TIME:CREPetition" on page 500
- ":TRIGger:FLEXray:TIME:SEGment" on page 501
- ":TRIGger:FLEXray:TIME:SLOT" on page 502
- ":TRIGger:FLEXray:TRIGger" on page 503
- **FORMat Commands:**
 - ":HARDcopy:FORMat" on page 662
 - ":SAVE:IMAGe:FORMat" on page 396
 - ":SAVE:WAVeform:FORMat" on page 403
 - ":WAVeform:FORMat" on page 585
- **FRAMe Commands:**
 - ":TRIGger:FLEXray:FRAMe:CCBase" on page 495
 - ":TRIGger:FLEXray:FRAMe:CCRepetition" on page 496
 - ":TRIGger:FLEXray:FRAMe:ID" on page 497
 - ":TRIGger:FLEXray:FRAMe:TYPE" on page 498
 - ":TRIGger:SPI:SOURce:FRAMe" on page 546
- **FRAMing Commands:**
 - ":SBUS:UART:FRAMing" on page 432
 - ":TRIGger:SPI:FRAMing" on page 541
- **FREQuency, ":MEASure:FREQuency" on page 311**
- ":FUNCTion:CENTer" on page 258
- ":FUNCTion:DISPlay" on page 259
- ":FUNCTion:GOFT:OPERation" on page 260
- ":FUNCTion:GOFT:SOURce1" on page 261
- ":FUNCTion:GOFT:SOURce2" on page 262
- ":FUNCTion:OFFSet" on page 263
- ":FUNCTion:OPERation" on page 264
- ":FUNCTion:RANGe" on page 265
- ":FUNCTion:REFerence" on page 266
- ":FUNCTion:SCALE" on page 267

- [":FUNCTION:SOURce"](#) on page 657
 - [":FUNCTION:SOURce1"](#) on page 268
 - [":FUNCTION:SOURce2"](#) on page 269
 - [":FUNCTION:SPAN"](#) on page 270
 - [":FUNCTION:VIEW"](#) on page 658
 - [":FUNCTION:WINDow"](#) on page 271
 - FWAVEforms, [":MTESt:COUNt:FWAVEforms"](#) on page 356
- G**
- GLITCh (Pulse Width), [":TRIGger:GLITCh Commands"](#) on page 504
 - GOFT Commands:
 - [":FUNCTION:GOFT:OPERation"](#) on page 260
 - [":FUNCTION:GOFT:SOURce1"](#) on page 261
 - [":FUNCTION:GOFT:SOURce2"](#) on page 262
 - GRAYscale, [":HARDcopy:GRAYscale"](#) on page 663
 - GREaterthan Commands:
 - [":TRIGger:DURation:GREaterthan"](#) on page 477
 - [":TRIGger:GLITCh:GREaterthan"](#) on page 506
- H**
- [":HARDcopy:AREA"](#) on page 274
 - [":HARDcopy:APRinter"](#) on page 275
 - [":HARDcopy:DESTination"](#) on page 659
 - [":HARDcopy:DEVice"](#) on page 660
 - [":HARDcopy:FACTors"](#) on page 276
 - [":HARDcopy:FFEed"](#) on page 277
 - [":HARDcopy:FILEname"](#) on page 661
 - [":HARDcopy:FORMat"](#) on page 662
 - [":HARDcopy:GRAYscale"](#) on page 663
 - [":HARDcopy:IGColors"](#) on page 664
 - [":HARDcopy:INKSaver"](#) on page 278
 - [":HARDcopy:LAYout"](#) on page 279
 - [":HARDcopy:PALette"](#) on page 280
 - [":HARDcopy:PDRiver"](#) on page 665
 - [":HARDcopy:PRINter:LIST"](#) on page 281
 - [":HARDcopy:START"](#) on page 282
 - HFReject, [":TRIGger:HFReject"](#) on page 458
 - HOLDoff, [":TRIGger:HOLDoff"](#) on page 459

- ":HWEenable (Hardware Event Enable Register)" on page 144
 - ":HWERegister:CONDition (Hardware Event Condition Register)" on page 146
 - ":HWERegister[:EVENT] (Hardware Event Event Register)" on page 148
- I**
- ID Commands:
 - ":TRIGger:CAN:PATtern:ID" on page 469
 - ":TRIGger:CAN:PATtern:ID:MODE" on page 470
 - ":TRIGger:FLEXray:FRAMe:ID" on page 497
 - IDLE Commands:
 - ":TRIGger:EBURst:IDLE" on page 484
 - ":TRIGger:UART:IDLE" on page 560
 - "*IDN (Identification Number)" on page 114
 - IIC Commands:
 - ":SBUS:IIC:ASIZE" on page 423
 - ":TRIGger:IIC Commands" on page 513
 - IGColors Commands:
 - ":HARDcopy:IGColors" on page 664
 - ":SAVE:IMAGe:INKSaver" on page 397
 - IMAGe Commands:
 - ":RECall:IMAGe[:STARt]" on page 386
 - ":SAVE:IMAGe:AREA" on page 394
 - ":SAVE:IMAGe:FACTors" on page 395
 - ":SAVE:IMAGe:FORMat" on page 396
 - ":SAVE:IMAGe:INKSaver" on page 397
 - ":SAVE:IMAGe:PALette" on page 398
 - ":SAVE:IMAGe[:STARt]" on page 393
 - IMPedance Commands:
 - ":CHANnel<n>:IMPedance" on page 215
 - ":EXTernal:IMPedance" on page 248
 - INCRement, ":MEASure:STATistics:INCRement" on page 328
 - INDEx, ":ACQuire:SEGmented:INDEx" on page 184
 - INKSaver, ":HARDcopy:INKSaver" on page 278
 - INVErt, ":CHANnel<n>:INVErt" on page 216
- L**
- LABEL Commands:
 - ":BUS<n>:LABel" on page 197

- [":CALibrate:LABel"](#) on page 202
 - [":CHANnel:LABel"](#) on page 647
 - [":CHANnel<n>:LABel"](#) on page 217
 - [":DIGital<n>:LABel"](#) on page 231
 - [":DISPlay:LABel"](#) on page 240
 - LABList, [":DISPlay:LABList"](#) on page 241
 - LAYout, [":HARDcopy:LAYout"](#) on page 279
 - LENGth Commands:
 - [":SAVE:WAVeform:LENGth"](#) on page 404
 - [":TRIGger:CAN:PATtern:DATA:LENGth"](#) on page 468
 - LESSthan Commands:
 - [":TRIGger:DURation:LESSthan"](#) on page 478
 - [":TRIGger:GLITch:LESSthan"](#) on page 507
 - LEVel Commands:
 - [":TRIGger\[:EDGE\]:LEVel"](#) on page 488
 - [":TRIGger:GLITch:LEVel"](#) on page 508
 - LIN Commands:
 - [":SBUS:LIN:PARity"](#) on page 424
 - [":TRIGger:LIN Commands"](#) on page 522
 - LINE, [":TRIGger:TV:LINE"](#) on page 548
 - LIST, [":HARDcopy:PRINter:LIST"](#) on page 281
 - LOAD, [":MTESt:LOAD"](#) on page 683
 - LOCK Commands:
 - [":MTESt:LOCK"](#) on page 363
 - [":SYSTem:LOCK"](#) on page 437
 - [":SYSTem:PROTection:LOCK"](#) on page 438
 - LOWer, [":MEASure:LOWer"](#) on page 666
 - ["*LRN \(Learn Device Setup\)"](#) on page 115
- M**
- [":MARKer:MODE"](#) on page 285
 - [":MARKer:X1Position"](#) on page 286
 - [":MARKer:X1Y1source"](#) on page 287
 - [":MARKer:X2Position"](#) on page 288
 - [":MARKer:X2Y2source"](#) on page 289
 - [":MARKer:XDELta"](#) on page 290
 - [":MARKer:Y1Position"](#) on page 291

- [":MARKer:Y2Position"](#) on page 292
- [":MARKer:YDELta"](#) on page 293
- MASK Commands:
 - [":BUS<n>:MASK"](#) on page 198
 - [":RECall:MASK\[:STARt\]"](#) on page 387
 - [":SAVE:MASK\[:STARt\]"](#) on page 399
- [":MEASure:CLEAr"](#) on page 302
- [":MEASure:COUNter"](#) on page 303
- [":MEASure:DEFine"](#) on page 304
- [":MEASure:DELay"](#) on page 307
- [":MEASure:DUTYcycle"](#) on page 309
- [":MEASure:FALLtime"](#) on page 310
- [":MEASure:FREQuency"](#) on page 311
- [":MEASure:LOWer"](#) on page 666
- [":MEASure:NWIDth"](#) on page 312
- [":MEASure:OVERshoot"](#) on page 313
- [":MEASure:PERiod"](#) on page 315
- [":MEASure:PHASe"](#) on page 316
- [":MEASure:PREShoot"](#) on page 317
- [":MEASure:PWIDth"](#) on page 318
- [":MEASure:RESults"](#) on page 319
- [":MEASure:RISetime"](#) on page 322
- [":MEASure:SCRatch"](#) on page 667
- [":MEASure:SDEVIation"](#) on page 323
- [":MEASure:SHOW"](#) on page 324
- [":MEASure:SOURce"](#) on page 325
- [":MEASure:STATistics"](#) on page 327
- [":MEASure:STATistics:INCRement"](#) on page 328
- [":MEASure:STATistics:RESet"](#) on page 329
- [":MEASure:TDELta"](#) on page 668
- [":MEASure:TEDGE"](#) on page 330
- [":MEASure:THResholds"](#) on page 669
- [":MEASure:TMAX"](#) on page 670
- [":MEASure:TMIN"](#) on page 671
- [":MEASure:TSTARt"](#) on page 672

- [":MEASure:TSTOp"](#) on page 673
- [":MEASure:TVALue"](#) on page 332
- [":MEASure:TVOLt"](#) on page 674
- [":MEASure:UPPer"](#) on page 676
- [":MEASure:VAMPLitude"](#) on page 334
- [":MEASure:VAverage"](#) on page 335
- [":MEASure:VBASe"](#) on page 336
- [":MEASure:VDELta"](#) on page 677
- [":MEASure:VMAX"](#) on page 337
- [":MEASure:VMIN"](#) on page 338
- [":MEASure:VPP"](#) on page 339
- [":MEASure:VRATio"](#) on page 340
- [":MEASure:VRMS"](#) on page 341
- [":MEASure:VSTArt"](#) on page 678
- [":MEASure:VSTOp"](#) on page 679
- [":MEASure:VTIME"](#) on page 342
- [":MEASure:VTOp"](#) on page 343
- [":MEASure:XMAX"](#) on page 344
- [":MEASure:XMIN"](#) on page 345
- [":MERGe"](#) on page 150
- **MODE Commands:**
 - [":ACquire:MODE"](#) on page 179
 - [":MARKer:MODE"](#) on page 285
 - [":SBUS:BUSDoctor:MODE"](#) on page 412
 - [":SBUS:MODE"](#) on page 425
 - [":TIMEbase:MODE"](#) on page 444
 - [":TRIGger:CAN:PATtern:ID:MODE"](#) on page 470
 - [":TRIGger:MODE"](#) on page 460
 - [":TRIGger:TV:MODE"](#) on page 549
 - [":WAVeform:POINts:MODE"](#) on page 588
- [":MTEenable \(Mask Test Event Enable Register\)"](#) on page 151
- [":MTERegister\[:EVENT\] \(Mask Test Event Event Register\)"](#) on page 153
- [":MTESt:AMASk:CREate"](#) on page 351
- [":MTESt:AMASk:{SAVE | STORE}"](#) on page 680
- [":MTESt:AMASk:SOURce"](#) on page 352

- ":MTEST:AMASK:UNITS" on page 353
 - ":MTEST:AMASK:XDELta" on page 354
 - ":MTEST:AMASK:YDELta" on page 355
 - ":MTEST:AVERage" on page 681
 - ":MTEST:AVERage:COUNT" on page 682
 - ":MTEST:COUNT:FWAVEforms" on page 356
 - ":MTEST:COUNT:RESet" on page 357
 - ":MTEST:COUNT:TIME" on page 358
 - ":MTEST:COUNT:WAVEforms" on page 359
 - ":MTEST:DATA" on page 360
 - ":MTEST:DELeTe" on page 361
 - ":MTEST:ENABle" on page 362
 - ":MTEST:LOAD" on page 683
 - ":MTEST:LOCK" on page 363
 - ":MTEST:OUTPut" on page 364
 - ":MTEST:RMODE" on page 365
 - ":MTEST:RMODE:FACTION:PRINt" on page 366
 - ":MTEST:RMODE:FACTION:SAVE" on page 367
 - ":MTEST:RMODE:FACTION:STOP" on page 368
 - ":MTEST:RMODE:SIGMa" on page 369
 - ":MTEST:RMODE:TIME" on page 370
 - ":MTEST:RMODE:WAVEforms" on page 371
 - ":MTEST:RUMode" on page 684
 - ":MTEST:RUMode:SOFailure" on page 685
 - ":MTEST:SCALE:BIND" on page 372
 - ":MTEST:SCALE:X1" on page 373
 - ":MTEST:SCALE:XDELta" on page 374
 - ":MTEST:SCALE:Y1" on page 375
 - ":MTEST:SCALE:Y2" on page 376
 - ":MTEST:SOURce" on page 377
 - ":MTEST:{STARt | STOP}" on page 686
 - ":MTEST:TITLe" on page 378
 - ":MTEST:TRIGger:SOURce" on page 687
- N**
- NREJect, ":TRIGger:NREJect" on page 461
 - NULL, ":SBUS:FLEXray:COUNT:NULL" on page 419

- NWIDth, ":MEASure:NWIDth" on page 312
- O**
 - OFFSet Commands:
 - ":CHANnel<n>:OFFSet" on page 218
 - ":FUNcTion:OFFSet" on page 263
 - "*OPC (Operation Complete)" on page 116
 - ":OPEE (Operation Status Enable Register)" on page 155
 - OPERation Commands:
 - ":FUNcTion:GOFT:OPERation" on page 260
 - ":FUNcTion:OPERation" on page 264
 - ":OPERegister:CONDition (Operation Status Condition Register)" on page 157
 - ":OPERegister[:EVENT] (Operation Status Event Register)" on page 159
 - "*OPT (Option Identification)" on page 117
 - ORDER, ":DISPlay:ORDER" on page 653
 - OUTPut Commands:
 - ":CALibrate:OUTPut" on page 203
 - ":MTESt:OUTPut" on page 364
 - OVERload, ":SBUS:CAN:COUNT:OVERload" on page 414
 - OVERshoot, ":MEASure:OVERshoot" on page 313
 - ":OVLenable (Overload Event Enable Register)" on page 161
 - ":OVLRegister (Overload Event Register)" on page 163
- P**
 - PALette Commands:
 - ":HARDcopy:PALette" on page 280
 - ":SAVE:IMAGe:PALette" on page 398
 - PARity Commands:
 - ":SBUS:LIN:PARity" on page 424
 - ":TRIGger:UART:PARity" on page 561
 - PATTern Commands:
 - ":TRIGger:CAN:PATTern:DATA" on page 467
 - ":TRIGger:CAN:PATTern:DATA:LENGth" on page 468
 - ":TRIGger:CAN:PATTern:ID" on page 469
 - ":TRIGger:CAN:PATTern:ID:MODE" on page 470
 - ":TRIGger:DURation:PATTern" on page 479
 - ":TRIGger:IIC:PATTern:ADDReSS" on page 514
 - ":TRIGger:IIC:PATTern:DATA" on page 515

- ":TRIGger:IIC:PATtern:DATA2" on page 516
- ":TRIGger:PATtern" on page 462
- ":TRIGger:SEquence:PATtern" on page 534
- ":TRIGger:SPI:PATtern:DATA" on page 542
- ":TRIGger:SPI:PATtern:WIDTh" on page 543
- PDRiver, ":HARDcopy:PDRiver" on page 665
- PERiod, ":MEASure:PERiod" on page 315
- PERsistence, ":DISPlay:PERsistence" on page 242
- PHASe, ":MEASure:PHASe" on page 316
- PMODE, ":CHANnel<n>:PMODE" on page 651
- ":POD<n>:DISPlay" on page 380
- ":POD<n>:SIZE" on page 381
- ":POD<n>:THReshold" on page 382
- POINTs Commands:
 - ":ACQuire:POINTs" on page 180
 - ":WAVeform:POINTs" on page 586
 - ":WAVeform:POINTs:MODE" on page 588
- POLarity Commands:
 - ":TRIGger:GLITCh:POLarity" on page 509
 - ":TRIGger:TV:POLarity" on page 550
 - ":TRIGger:UART:POLarity" on page 562
- POSition Commands:
 - ":DIGital<n>:POSition" on page 232
 - ":TIMebase:POSition" on page 445
 - ":TIMebase:WINDow:POSition" on page 451
- PREamble, ":WAVeform:PREamble" on page 590
- PREShoot, ":MEASure:PREShoot" on page 317
- PRINT, ":MTESt:RMODE:FACTion:PRINT" on page 366
- ":PRINT" on page 165
- ":PRINT?" on page 688
- PRINter, ":HARDcopy:PRINter:LIST" on page 281
- PROBe Commands:
 - ":CHANnel<n>:PROBe" on page 219
 - ":EXTernal:PROBe" on page 249
- PROTection Commands:

- ":CHANnel<n>:PROTection" on page 223
- ":EXTeRnal:PROTection" on page 252
- ":SYSTem:PROTection:LOCK" on page 438
- Pulse Width (GLITch), ":TRIGger:GLITch Commands" on page 504
- PWD Commands:
 - ":RECall:PWD" on page 388
 - ":SAVE:PWD" on page 400
- PWIDth, ":MEASure:PWIDth" on page 318
- Q**
 - QUALifier Commands:
 - ":TRIGger:DURation:QUALifier" on page 480
 - ":TRIGger:GLITch:QUALifier" on page 510
 - ":TRIGger:IIC:TRIGger:QUALifier" on page 519
 - ":TRIGger:UART:QUALifier" on page 563
- R**
 - RANGe Commands:
 - ":CHANnel<n>:RANGe" on page 224
 - ":EXTeRnal:RANGe" on page 253
 - ":FUNCTion:RANGe" on page 265
 - ":TIMebase:RANGe" on page 446
 - ":TIMebase:WINDow:RANGe" on page 452
 - ":TRIGger:DURation:RANGe" on page 481
 - ":TRIGger:GLITch:RANGe" on page 511
 - "*RCL (Recall)" on page 119
 - ":RECall:FILEname" on page 385
 - ":RECall:IMAGe[:STARt]" on page 386
 - ":RECall:MASK[:STARt]" on page 387
 - ":RECall:PWD" on page 388
 - ":RECall:SETup[:STARt]" on page 389
 - REFClock, ":TIMebase:REFClock" on page 447
 - REFerence Commands:
 - ":FUNCTion:REFerence" on page 266
 - ":TIMebase:REFerence" on page 448
 - REJect, ":TRIGger[:EDGE]:REJect" on page 489
 - RESet Commands:
 - ":MEASure:STATistics:RESet" on page 329

- ":MTESt:COUNT:RESet" on page 357
- ":SBUS:CAN:COUNT:RESet" on page 415
- ":SBUS:FLEXray:COUNT:RESet" on page 420
- ":SBUS:UART:COUNT:RESet" on page 429
- ":TRIGger:SEQuence:RESet" on page 535
- RESults, ":MEASure:RESults" on page 319
- RISetime, ":MEASure:RISetime" on page 322
- RMODE Commands:
 - ":MTESt:RMODE" on page 365
 - ":MTESt:RMODE:FACTion:PRINT" on page 366
 - ":MTESt:RMODE:FACTion:SAVE" on page 367
 - ":MTESt:RMODE:FACTion:STOP" on page 368
 - ":MTESt:RMODE:SIGMa" on page 369
 - ":MTESt:RMODE:TIME" on page 370
 - ":MTESt:RMODE:WAVEforms" on page 371
- "Root (:): Commands" on page 131
- RSIGnal, ":ACQuire:RSIGnal" on page 181
- "*RST (Reset)" on page 120
- RUMode Commands:
 - ":MTESt:RUMode" on page 684
 - ":MTESt:RUMode:SOFailure" on page 685
- ":RUN" on page 166
- RX, ":TRIGger:UART:SOURce:RX" on page 564
- RXFRames, ":SBUS:UART:COUNT:RXFRames" on page 430
- S**
 - SAMPlEpoint Commands:
 - ":TRIGger:CAN:SAMPlEpoint" on page 471
 - ":TRIGger:LIN:SAMPlEpoint" on page 524
 - "*SAV (Save)" on page 123
 - SAVE Commands:
 - ":MTESt:AMASK:{SAVE | STORE}" on page 680
 - ":MTESt:RMODE:FACTion:SAVE" on page 367
 - ":SAVE:FILEname" on page 392
 - ":SAVE:IMAGe:AREA" on page 394
 - ":SAVE:IMAGe:FACTors" on page 395
 - ":SAVE:IMAGe:FORMat" on page 396

- [":SAVE:IMAGe:INKSaver"](#) on page 397
- [":SAVE:IMAGe:PALette"](#) on page 398
- [":SAVE:IMAGe\[:STARt\]"](#) on page 393
- [":SAVE:MASK\[:STARt\]"](#) on page 399
- [":SAVE:PWD"](#) on page 400
- [":SAVE:SETup\[:STARt\]"](#) on page 401
- [":SAVE:WAVeform:FORMat"](#) on page 403
- [":SAVE:WAVeform:LENGth"](#) on page 404
- [":SAVE:WAVeform:SEGMENTed"](#) on page 405
- [":SAVE:WAVeform\[:STARt\]"](#) on page 402
- [":SBUS:BUSDoctor:ADDReSS"](#) on page 409
- [":SBUS:BUSDoctor:BAUDrate"](#) on page 410
- [":SBUS:BUSDoctor:CHANnel"](#) on page 411
- [":SBUS:BUSDoctor:MODE"](#) on page 412
- [":SBUS:CAN:COUNT:ERRor"](#) on page 413
- [":SBUS:CAN:COUNT:OVERload"](#) on page 414
- [":SBUS:CAN:COUNT:RESet"](#) on page 415
- [":SBUS:CAN:COUNT:TOTal"](#) on page 416
- [":SBUS:CAN:COUNT:UTILization"](#) on page 417
- [":SBUS:DISPlay"](#) on page 418
- [":SBUS:FLEXray:COUNT:NULL"](#) on page 419
- [":SBUS:FLEXray:COUNT:RESet"](#) on page 420
- [":SBUS:FLEXray:COUNT:SYNC"](#) on page 421
- [":SBUS:FLEXray:COUNT:TOTal"](#) on page 422
- [":SBUS:IIC:ASIZe"](#) on page 423
- [":SBUS:LIN:PARity"](#) on page 424
- [":SBUS:MODE"](#) on page 425
- [":SBUS:SPI:WIDTh"](#) on page 426
- [":SBUS:UART:BASE"](#) on page 427
- [":SBUS:UART:COUNT:ERRor"](#) on page 428
- [":SBUS:UART:COUNT:RESet"](#) on page 429
- [":SBUS:UART:COUNT:RXFRames"](#) on page 430
- [":SBUS:UART:COUNT:TXFRames"](#) on page 431
- [":SBUS:UART:FRAMing"](#) on page 432
- SCALe Commands:

- ":CHANnel<n>:SCALE" on page 225
- ":FUNction:SCALE" on page 267
- ":MTESt:SCALE:BIND" on page 372
- ":MTESt:SCALE:X1" on page 373
- ":MTESt:SCALE:XDELta" on page 374
- ":MTESt:SCALE:Y1" on page 375
- ":MTESt:SCALE:Y2" on page 376
- ":TIMEbase:SCALE" on page 449
- ":TIMEbase:WINDow:SCALE" on page 453
- SCRatch, ":MEASure:SCRatch" on page 667
- SDEVIation, ":MEASure:SDEVIation" on page 323
- ":SERial" on page 167
- SEGment, ":TRIGger:FLEXray:TIME:SEGment" on page 501
- SEGmented Commands:
 - ":ACquire:SEGmented:ANALyze" on page 182
 - ":ACquire:SEGmented:COUNT" on page 183
 - ":ACquire:SEGmented:INDEX" on page 184
 - ":SAVE:WAVEform:SEGmented" on page 405
 - ":WAVEform:SEGmented:COUNT" on page 593
 - ":WAVEform:SEGmented:TTAG" on page 594
- SETup Commands:
 - ":RECall:SETup[:START]" on page 389
 - ":SAVE:SETup[:START]" on page 401
 - ":SYSTem:SETup" on page 439
- SEQuence, ":TRIGger:SEQuence Commands" on page 530
- SHOW, ":MEASure:SHOW" on page 324
- SLOT, ":TRIGger:FLEXray:TIME:SLOT" on page 502
- SIGMa, ":MTESt:RMODE:SIGMa" on page 369
- SIGNal Commands:
 - ":TRIGger:CAN:SIGNal:BAUDrate" on page 472
 - ":TRIGger:CAN:SIGNal:DEFinition" on page 692
 - ":TRIGger:LIN:SIGNal:BAUDrate" on page 525
 - ":TRIGger:LIN:SIGNal:DEFinition" on page 693
- ":SINGLE" on page 168
- SIZE Commands:

- [":DIGital<n>:SIZE"](#) on page 233
- [":POD<n>:SIZE"](#) on page 381
- SKEW, [":CHANnel<n>:PROBe:SKEW"](#) on page 221
- SLOPe Commands:
 - [":TRIGger:EBURst:SLOPe"](#) on page 485
 - [":TRIGger\[:EDGE\]:SLOPe"](#) on page 490
 - [":TRIGger:SPI:CLOCK:SLOPe"](#) on page 539
- SOFailure, [":MTESt:RUMode:SOFailure"](#) on page 685
- SOURce Commands:
 - [":DISPlay:SOURce"](#) on page 243
 - [":FUNCTion:SOURce"](#) on page 657
 - [":MEASure:SOURce"](#) on page 325
 - [":MTESt:AMASk:SOURce"](#) on page 352
 - [":MTESt:SOURce"](#) on page 377
 - [":MTESt:TRIGger:SOURce"](#) on page 687
 - [":TRIGger:CAN:SOURce"](#) on page 473
 - [":TRIGger:GLITCh:SOURce"](#) on page 512
 - [":TRIGger:IIC\[:SOURce\]:CLOCK"](#) on page 517
 - [":TRIGger:IIC\[:SOURce\]:DATA"](#) on page 518
 - [":TRIGger:LIN:SOURce"](#) on page 526
 - [":TRIGger:SPI:SOURce:CLOCK"](#) on page 544
 - [":TRIGger:SPI:SOURce:DATA"](#) on page 545
 - [":TRIGger:SPI:SOURce:FRAME"](#) on page 546
 - [":TRIGger:TV:SOURce"](#) on page 551
 - [":TRIGger:UART:SOURce:RX"](#) on page 564
 - [":TRIGger:UART:SOURce:TX"](#) on page 565
 - [":TRIGger:USB:SOURce:DMINus"](#) on page 569
 - [":TRIGger:USB:SOURce:DPLus"](#) on page 570
 - [":WAVEform:SOURce"](#) on page 595
 - [":WAVEform:SOURce:SUBSource"](#) on page 599
- SOURce1 Commands:
 - [":FUNCTion:GOFT:SOURce1"](#) on page 261
 - [":FUNCTion:SOURce1"](#) on page 268
- SOURce2 Commands:
 - [":FUNCTion:GOFT:SOURce2"](#) on page 262

- ":FUNction:SOURce2" on page 269
- SPAN, ":FUNction:SPAN" on page 270
- SPEEd, ":TRIGger:USB:SPEEd" on page 571
- SPI Commands:
 - ":SBUS:SPI:WIDTh" on page 426
 - ":TRIGger:SPI Commands" on page 538
- SRATe, ":ACQuire:SRATe" on page 187
- "*SRE (Service Request Enable)" on page 124
- STANdard Commands:
 - ":TRIGger:LIN:STANdard" on page 527
 - ":TRIGger:TV:STANdard" on page 552
- STARt Commands:
 - ":CALibrate:STARt" on page 204
 - ":HARDcopy:STARt" on page 282
 - ":MTESt:{STARt | STOP}" on page 686
 - ":RECall:IMAGe[:STARt]" on page 386
 - ":RECall:MASK[:STARt]" on page 387
 - ":RECall:SETup[:STARt]" on page 389
 - ":SAVE:IMAGe[:STARt]" on page 393
 - ":SAVE:MASK[:STARt]" on page 399
 - ":SAVE:SETup[:STARt]" on page 401
 - ":SAVE:WAVEform[:STARt]" on page 402
- STATistics Commands:
 - ":MEASure:STATistics" on page 327
 - ":MEASure:STATistics:INCRement" on page 328
 - ":MEASure:STATistics:RESet" on page 329
- STATus Commands:
 - ":CALibrate:STATus" on page 205
 - ":STATus" on page 169
- "*STB (Read Status Byte)" on page 126
- STOP Commands:
 - ":MTESt:RMODE:FACTion:STOP" on page 368
 - ":MTESt:{STARt | STOP}" on page 686
- ":STOP" on page 170
- STORe, ":MTESt:AMASK:{SAVE | STORe}" on page 680

- SUBSource, ":WAVEform:SOURce:SUBSource" on page 599
 - SWEep, ":TRIGger:SWEep" on page 464
 - SWITCh, ":CALibrate:SWITCh" on page 206
 - SYNC, ":SBUS:FLEXray:COUNT:SYNC" on page 421
 - SYNCbreak, ":TRIGger:LIN:SYNCbreak" on page 528
 - ":SYSTem:DATE" on page 434
 - ":SYSTem:DSP" on page 435
 - ":SYSTem:ERRor" on page 436
 - ":SYSTem:LOCK" on page 437
 - ":SYSTem:SETup" on page 439
 - ":SYSTem:TIME" on page 441
- T**
- TDELta, ":MEASure:TDELta" on page 668
 - TEDGe, ":MEASure:TEDGe" on page 330
 - TEMPerature, ":CALibrate:TEMPerature" on page 207
 - ":TER (Trigger Event Register)" on page 171
 - THReshold Commands:
 - ":CHANnel:THReshold" on page 648
 - ":DIGital<n>:THReshold" on page 234
 - ":MEASure:THResholds" on page 669
 - ":POD<n>:THReshold" on page 382
 - ":TRIGger:THReshold" on page 694
 - THResholds, ":MEASure:THResholds" on page 669
 - TIME Commands:
 - ":CALibrate:TIME" on page 208
 - ":MTEST:COUNT:TIME" on page 358
 - ":MTEST:RMODE:TIME" on page 370
 - ":SYSTem:TIME" on page 441
 - ":TRIGger:FLEXray:TIME:CBASE" on page 499
 - ":TRIGger:FLEXray:TIME:CREPetition" on page 500
 - ":TRIGger:FLEXray:TIME:SEGMENT" on page 501
 - ":TRIGger:FLEXray:TIME:SLOT" on page 502
 - ":TIMEbase:DELay" on page 690
 - ":TIMEbase:MODE" on page 444
 - ":TIMEbase:POSition" on page 445
 - ":TIMEbase:RANGE" on page 446

- ":TIMEbase:REFClock" on page 447
- ":TIMEbase:REFErence" on page 448
- ":TIMEbase:SCALE" on page 449
- ":TIMEbase:VERNier" on page 450
- ":TIMEbase:WINDow:POSition" on page 451
- ":TIMEbase:WINDow:RANGE" on page 452
- ":TIMEbase:WINDow:SCALE" on page 453
- TIMEout, ":TRIGger:SPI:CLOCK:TIMEout" on page 540
- TIMer, ":TRIGger:SEQuence:TIMer" on page 536
- TITLe, ":MTESt:TITLe" on page 378
- TMAX, ":MEASure:TMAX" on page 670
- TMIN, ":MEASure:TMIN" on page 671
- TOTAl Commands:
 - ":SBUS:CAN:COUNt:TOTAl" on page 416
 - ":SBUS:FLEXray:COUNt:TOTAl" on page 422
- "*TRG (Trigger)" on page 128
- TRIGger Commands:
 - ":MTESt:TRIGger:SOURce" on page 687
 - ":TRIGger:CAN:TRIGger" on page 474
 - ":TRIGger:FLEXray:TRIGger" on page 503
 - ":TRIGger:IIC:TRIGger:QUALifier" on page 519
 - ":TRIGger:IIC:TRIGger[:TYPE]" on page 520
 - ":TRIGger:LIN:TRIGger" on page 529
 - ":TRIGger:SEQuence:TRIGger" on page 537
 - ":TRIGger:USB:TRIGger" on page 572
- ":TRIGger:HFReject" on page 458
- ":TRIGger:HOLDoff" on page 459
- ":TRIGger:MODE" on page 460
- ":TRIGger:NREJect" on page 461
- ":TRIGger:PATtern" on page 462
- ":TRIGger:SWEep" on page 464
- ":TRIGger:THReshold" on page 694
- ":TRIGger:CAN:ACKnowledge" on page 691
- ":TRIGger:CAN:PATtern:DATA" on page 467
- ":TRIGger:CAN:PATtern:DATA:LENGth" on page 468

- [":TRIGger:CAN:PATtern:ID"](#) on page 469
- [":TRIGger:CAN:PATtern:ID:MODE"](#) on page 470
- [":TRIGger:CAN:SAMPlepoint"](#) on page 471
- [":TRIGger:CAN:SIGNal:BAUDrate"](#) on page 472
- [":TRIGger:CAN:SIGNal:DEFinition"](#) on page 692
- [":TRIGger:CAN:SOURce"](#) on page 473
- [":TRIGger:CAN:TRIGger"](#) on page 474
- [":TRIGger:DURation:GREaterthan"](#) on page 477
- [":TRIGger:DURation:LESSthan"](#) on page 478
- [":TRIGger:DURation:PATtern"](#) on page 479
- [":TRIGger:DURation:QUALifier"](#) on page 480
- [":TRIGger:DURation:RANGe"](#) on page 481
- [":TRIGger\[:EDGE\]:COUPling"](#) on page 487
- [":TRIGger\[:EDGE\]:LEVel"](#) on page 488
- [":TRIGger\[:EDGE\]:REJect"](#) on page 489
- [":TRIGger\[:EDGE\]:SLOPe"](#) on page 490
- [":TRIGger\[:EDGE\]:SOURce"](#) on page 491
- [":TRIGger:FLEXray:ERRor:TYPE"](#) on page 493
- [":TRIGger:FLEXray:FRAMe:CCBase"](#) on page 495
- [":TRIGger:FLEXray:FRAMe:CCRepetition"](#) on page 496
- [":TRIGger:FLEXray:FRAMe:ID"](#) on page 497
- [":TRIGger:FLEXray:FRAMe:TYPE"](#) on page 498
- [":TRIGger:FLEXray:TIME:CBASe"](#) on page 499
- [":TRIGger:FLEXray:TIME:CREPetition"](#) on page 500
- [":TRIGger:FLEXray:TIME:SEGMENT"](#) on page 501
- [":TRIGger:FLEXray:TIME:SLOT"](#) on page 502
- [":TRIGger:FLEXray:TRIGger"](#) on page 503
- [":TRIGger:GLITch:GREaterthan"](#) on page 506
- [":TRIGger:GLITch:LESSthan"](#) on page 507
- [":TRIGger:GLITch:LEVel"](#) on page 508
- [":TRIGger:GLITch:POLarity"](#) on page 509
- [":TRIGger:GLITch:QUALifier"](#) on page 510
- [":TRIGger:GLITch:RANGe"](#) on page 511
- [":TRIGger:GLITch:SOURce"](#) on page 512
- [":TRIGger:HFReject"](#) on page 458

- [":TRIGger:HOLDoff"](#) on page 459
- [":TRIGger:IIC:PATtern:ADDResS"](#) on page 514
- [":TRIGger:IIC:PATtern:DATA"](#) on page 515
- [":TRIGger:IIC:PATtern:DATA2"](#) on page 516
- [":TRIGger:IIC\[:SOURce\]:CLOCK"](#) on page 517
- [":TRIGger:IIC\[:SOURce\]:DATA"](#) on page 518
- [":TRIGger:IIC:TRIGger:QUALifier"](#) on page 519
- [":TRIGger:IIC:TRIGger\[:TYPE\]"](#) on page 520
- [":TRIGger:LIN:SIGNal:BAUDrate"](#) on page 525
- [":TRIGger:LIN:SIGNal:DEFinition"](#) on page 693
- [":TRIGger:LIN:SOURce"](#) on page 526
- [":TRIGger:LIN:TRIGger"](#) on page 529
- [":TRIGger:MODE"](#) on page 460
- [":TRIGger:NREJect"](#) on page 461
- [":TRIGger:PATtern"](#) on page 462
- [":TRIGger:SEQuence:COUNT"](#) on page 531
- [":TRIGger:SEQuence:EDGE"](#) on page 532
- [":TRIGger:SEQuence:FIND"](#) on page 533
- [":TRIGger:SEQuence:PATtern"](#) on page 534
- [":TRIGger:SEQuence:RESet"](#) on page 535
- [":TRIGger:SEQuence:TIMer"](#) on page 536
- [":TRIGger:SEQuence:TRIGger"](#) on page 537
- [":TRIGger:SPI:CLOCK:SLOPe"](#) on page 539
- [":TRIGger:SPI:CLOCK:TIMEout"](#) on page 540
- [":TRIGger:SPI:FRAMing"](#) on page 541
- [":TRIGger:SPI:PATtern:DATA"](#) on page 542
- [":TRIGger:SPI:PATtern:WIDTh"](#) on page 543
- [":TRIGger:SPI:SOURce:CLOCK"](#) on page 544
- [":TRIGger:SPI:SOURce:DATA"](#) on page 545
- [":TRIGger:SPI:SOURce:FRAMe"](#) on page 546
- [":TRIGger:SWEep"](#) on page 464
- [":TRIGger:THReshold"](#) on page 694
- [":TRIGger:TV:LINE"](#) on page 548
- [":TRIGger:TV:MODE"](#) on page 549
- [":TRIGger:TV:POLarity"](#) on page 550

- [":TRIGger:TV:SOURce"](#) on page 551
- [":TRIGger:TV:STANdard"](#) on page 552
- [":TRIGger:TV:TVMoDe"](#) on page 695
- [":TRIGger:UART:BASE"](#) on page 555
- [":TRIGger:UART:BAUDrate"](#) on page 556
- [":TRIGger:UART:BITorder"](#) on page 557
- [":TRIGger:UART:BURSt"](#) on page 558
- [":TRIGger:UART:DATA"](#) on page 559
- [":TRIGger:UART:IDLE"](#) on page 560
- [":TRIGger:UART:PARity"](#) on page 561
- [":TRIGger:UART:POLarity"](#) on page 562
- [":TRIGger:UART:QUALifier"](#) on page 563
- [":TRIGger:UART:SOURce:RX"](#) on page 564
- [":TRIGger:UART:SOURce:TX"](#) on page 565
- [":TRIGger:UART:TYPE"](#) on page 566
- [":TRIGger:UART:WIDTh"](#) on page 567
- [":TRIGger:USB:SOURce:DMINus"](#) on page 569
- [":TRIGger:USB:SOURce:DPLus"](#) on page 570
- [":TRIGger:USB:SPEed"](#) on page 571
- [":TRIGger:USB:TRIGger"](#) on page 572
- ["*TST \(Self Test\)"](#) on page 129
- TSTArt, [":MEASure:TSTArt"](#) on page 672
- TSTOp, [":MEASure:TSTOp"](#) on page 673
- TTAG, [":WAVEform:SEGmented:TTAG"](#) on page 594
- TV, [":TRIGger:TV Commands"](#) on page 547
- TVALue, [":MEASure:TVALue"](#) on page 332
- TVOLt, [":MEASure:TVOLt"](#) on page 674
- TX, [":TRIGger:UART:SOURce:TX"](#) on page 565
- TXFRames, [":SBUS:UART:COUNt:TXFRames"](#) on page 431
- TYPE Commands:
 - [":ACQuire:TYPE"](#) on page 188
 - [":WAVEform:TYPE"](#) on page 600
 - [":TRIGger:FLEXray:ERRor:TYPE"](#) on page 493
 - [":TRIGger:FLEXray:FRAMe:TYPE"](#) on page 498
 - [":TRIGger:IIC:TRIGger\[:TYPE\]"](#) on page 520

- ":TRIGger:UART:TYPE" on page 566
- U**
 - UART Commands:
 - ":SBUS:UART:BASE" on page 427
 - ":SBUS:UART:COUNt:ERRor" on page 428
 - ":SBUS:UART:COUNt:RESet" on page 429
 - ":SBUS:UART:COUNt:RXFRames" on page 430
 - ":SBUS:UART:COUNt:TXFRames" on page 431
 - ":SBUS:UART:FRAMing" on page 432
 - ":TRIGger:UART:BASE" on page 555
 - ":TRIGger:UART:BAUDrate" on page 556
 - ":TRIGger:UART:BITorder" on page 557
 - ":TRIGger:UART:BURSt" on page 558
 - ":TRIGger:UART:DATA" on page 559
 - ":TRIGger:UART:IDLE" on page 560
 - ":TRIGger:UART:PARity" on page 561
 - ":TRIGger:UART:POLarity" on page 562
 - ":TRIGger:UART:QUALifier" on page 563
 - ":TRIGger:UART:SOURce:RX" on page 564
 - ":TRIGger:UART:SOURce:TX" on page 565
 - ":TRIGger:UART:TYPE" on page 566
 - ":TRIGger:UART:WIDTh" on page 567
 - UNITs Commands:
 - ":CHANnel<n>:UNITs" on page 226
 - ":EXtErnal:UNITs" on page 254
 - ":MTESt:AMASk:UNITs" on page 353
 - UNSigned, ":WAVEform:UNSigned" on page 601
 - UPPer, ":MEASure:UPPer" on page 676
 - USB, ":TRIGger:USB Commands" on page 568
 - UTILization, ":SBUS:CAN:COUNt:UTILization" on page 417
- V**
 - VAMplitude, ":MEASure:VAMplitude" on page 334
 - VAVerage, ":MEASure:VAVerage" on page 335
 - VBASe, ":MEASure:VBASe" on page 336
 - VDELta, ":MEASure:VDELta" on page 677
 - VECTors, ":DISPlay:VECTors" on page 244

- VERNier, ":CHANnel<n>:VERNier" on page 227
 - ":VIEW" on page 172
 - VMAX, ":MEASure:VMAX" on page 337
 - VMIN, ":MEASure:VMIN" on page 338
 - VPP, ":MEASure:VPP" on page 339
 - VRATio, ":MEASure:VRATio" on page 340
 - VRMS, ":MEASure:VRMS" on page 341
 - VSTArt, ":MEASure:VSTArt" on page 678
 - VSTOp, ":MEASure:VSTOp" on page 679
 - VTIMe, ":MEASure:VTIMe" on page 342
 - VTOP, ":MEASure:VTOP" on page 343
- W**
- "*WAI (Wait To Continue)" on page 130
 - WAVEform Commands:
 - ":SAVE:WAVEform:FORMat" on page 403
 - ":SAVE:WAVEform:LENGth" on page 404
 - ":SAVE:WAVEform[:STArt]" on page 402
 - ":WAVEform:BYTeorder" on page 581
 - ":WAVEform:COUNT" on page 582
 - ":WAVEform:DATA" on page 583
 - ":WAVEform:FORMat" on page 585
 - ":WAVEform:POINts" on page 586
 - ":WAVEform:POINts:MODE" on page 588
 - ":WAVEform:PREAmble" on page 590
 - ":WAVEform:SEGmented:COUNT" on page 593
 - ":WAVEform:SEGmented:TTAG" on page 594
 - ":WAVEform:SOURce" on page 595
 - ":WAVEform:SOURce:SUBSource" on page 599
 - ":WAVEform:TYPE" on page 600
 - ":WAVEform:UNSigned" on page 601
 - ":WAVEform:VIEW" on page 602
 - ":WAVEform:XINcrement" on page 603
 - ":WAVEform:XORigin" on page 604
 - ":WAVEform:XREFerence" on page 605
 - ":WAVEform:YINcrement" on page 606
 - ":WAVEform:YORigin" on page 607

- [":WAVEform:YREFerence"](#) on page 608
 - WAVEforms Commands:
 - [":MTESt:COUNt:WAVEforms"](#) on page 359
 - [":MTESt:RMODe:WAVEforms"](#) on page 371
 - WIDTH Commands:
 - [":SBUS:SPI:WIDTh"](#) on page 426
 - [":TRIGger:SPI:PATtern:WIDTh"](#) on page 543
 - [":TRIGger:UART:WIDTh"](#) on page 567
 - WINDOW, [":FUNcTION:WINDow"](#) on page 271
- X**
- X1, [":MTESt:SCALe:X1"](#) on page 373
 - X1Position, [":MARKer:X1Position"](#) on page 286
 - X1Y1source, [":MARKer:X1Y1source"](#) on page 287
 - X2Position, [":MARKer:X2Position"](#) on page 288
 - X2Y2source, [":MARKer:X2Y2source"](#) on page 289
 - XDELta Commands:
 - [":MARKer:XDELta"](#) on page 290
 - [":MTESt:AMASk:XDELta"](#) on page 354
 - [":MTESt:SCALe:XDELta"](#) on page 374
 - XINCrement, [":WAVEform:XINCrement"](#) on page 603
 - XMAX, [":MEASure:XMAX"](#) on page 344
 - XMIN, [":MEASure:XMIN"](#) on page 345
 - XORigin, [":WAVEform:XORigin"](#) on page 604
 - XREFerence, [":WAVEform:XREFerence"](#) on page 605
- Y**
- Y1, [":MTESt:SCALe:Y1"](#) on page 375
 - Y1Position, [":MARKer:Y1Position"](#) on page 291
 - Y2, [":MTESt:SCALe:Y2"](#) on page 376
 - Y2Position, [":MARKer:Y2Position"](#) on page 292
 - YDELta Commands:
 - [":MARKer:YDELta"](#) on page 293
 - [":MTESt:AMASk:YDELta"](#) on page 355
 - YINCrement, [":WAVEform:YINCrement"](#) on page 606
 - YORigin, [":WAVEform:YORigin"](#) on page 607
 - YREFerence, [":WAVEform:YREFerence"](#) on page 608

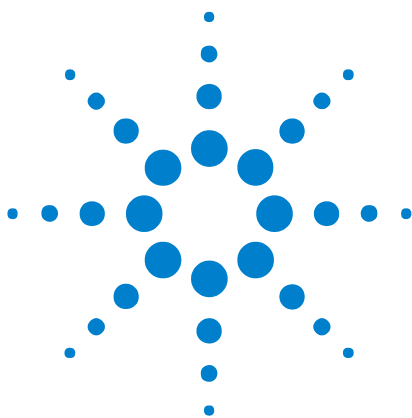

7 Obsolete and Discontinued Commands

Obsolete commands are older forms of commands that are provided to reduce customer rework for existing systems and programs (see "Obsolete Commands" on page 740).

Obsolete Command	Current Command Equivalent	Behavior Differences
ANALog<n>:BWLimit	:CHANnel<n>:BWLimit (see page 212)	
ANALog<n>:COUPling	:CHANnel<n>:COUPling (see page 213)	
ANALog<n>:INVert	:CHANnel<n>:INVert (see page 216)	
ANALog<n>:LABel	:CHANnel<n>:LABel (see page 217)	
ANALog<n>:OFFSet	:CHANnel<n>:OFFSet (see page 218)	
ANALog<n>:PROBe	:CHANnel<n>:PROBe (see page 219)	
ANALog<n>:PMODE	none	
ANALog<n>:RANGe	:CHANnel<n>:RANGe (see page 224)	
:CHANnel:ACTivity (see page 646)	:ACTivity (see page 134)	
:CHANnel:LABel (see page 647)	:CHANnel<n>:LABel (see page 217) or :DIGital<n>:LABel (see page 231)	use CHANnel<n>:LABel for analog channels and use DIGital<n>:LABel for digital channels
:CHANnel:THReshold (see page 648)	:POD<n>:THReshold (see page 382) or :DIGital<n>:THReshold (see page 234)	
:CHANnel2:SKEW (see page 649)	:CHANnel<n>:PROBe:SKEW (see page 221)	



7 Obsolete and Discontinued Commands

Obsolete Command	Current Command Equivalent	Behavior Differences
:CHANnel<n>:INPut (see page 650)	:CHANnel<n>:IMPedance (see page 215)	
:CHANnel<n>:PMODE (see page 651)	none	
:DISPlay:CONNect (see page 652)	:DISPlay:VECTors (see page 244)	
:DISPlay:ORDer (see page 653)	none	
:ERASe (see page 654)	:CDISplay (see page 141)	
:EXTernal:INPut (see page 655)	:EXTernal:IMPedance (see page 248)	
:EXTernal:PMODE (see page 656)	none	
FUNcTion1, FUNcTion2	:FUNcTion Commands (see page 255)	ADD not included
:FUNcTion:SOURce (see page 657)	:FUNcTion:SOURce1 (see page 268)	Obsolete command has ADD, SUBTRact, and MULTIPly parameters; current command has GOFT parameter.
:FUNcTion:VIEW (see page 658)	:FUNcTion:DISPlay (see page 259)	
:HARDcopy:DESTination (see page 659)	:HARDcopy:FILEname (see page 661)	
:HARDcopy:DEVice (see page 660)	:HARDcopy:FORMat (see page 662)	PLOTter, THINKjet not supported; TIF, BMP, CSV, SEIko added
:HARDcopy:FILEname (see page 661)	:RECall:FILEname (see page 385) :SAVE:FILEname (see page 385)	
:HARDcopy:FORMat (see page 662)	:HARDcopy:APRinter (see page 275) :SAVE:IMAGe:FORMat (see page 396) :SAVE:WAVEform:FORMat (see page 403)	
:HARDcopy:GRAYscale (see page 663)	:HARDcopy:PALette (see page 280)	
:HARDcopy:IGColors (see page 664)	:HARDcopy:INKSaver (see page 278)	

Obsolete Command	Current Command Equivalent	Behavior Differences
:HARDcopy:PDRiver (see page 665)	:HARDcopy:APRinter (see page 275)	
:MEASure:LOWer (see page 666)	:MEASure:DEFine:THResholds (see page 304)	MEASure:DEFine:THResholds can define absolute values or percentage
:MEASure:SCRatch (see page 667)	:MEASure:CLEar (see page 302)	
:MEASure:TDELta (see page 668)	:MARKer:XDELta (see page 290)	
:MEASure:THResholds (see page 669)	:MEASure:DEFine:THResholds (see page 304)	MEASure:DEFine:THResholds can define absolute values or percentage
:MEASure:TMAX (see page 670)	:MEASure:XMAX (see page 344)	
:MEASure:TMIN (see page 671)	:MEASure:XMIN (see page 345)	
:MEASure:TSTArt (see page 672)	:MARKer:X1Position (see page 286)	
:MEASure:TSTOp (see page 673)	:MARKer:X2Position (see page 288)	
:MEASure:TVOLt (see page 674)	:MEASure:TVALue (see page 332)	TVALue measures additional values such as db, Vs, etc.
:MEASure:UPPer (see page 676)	:MEASure:DEFine:THResholds (see page 304)	MEASure:DEFine:THResholds can define absolute values or percentage
:MEASure:VDELta (see page 677)	:MARKer:YDELta (see page 293)	
:MEASure:VSTArt (see page 678)	:MARKer:Y1Position (see page 291)	
:MEASure:VSTOp (see page 679)	:MARKer:Y2Position (see page 292)	
:MTESt:AMASK:{SAVE STORE} (see page 680)	:SAVE:MASK[:STArt] (see page 399)	
:MTESt:AVERAge (see page 681)	:ACQuire:TYPE AVERAge (see page 188)	
:MTESt:AVERAge:COUNt (see page 682)	:ACQuire:COUNt (see page 177)	
:MTESt:LOAD (see page 683)	:RECall:MASK[:STArt] (see page 387)	

7 Obsolete and Discontinued Commands

Obsolete Command	Current Command Equivalent	Behavior Differences
:MTESt:RUMode (see page 684)	:MTESt:RMODe (see page 365)	
:MTESt:RUMode:SOFailure (see page 685)	:MTESt:RMODe:FACTion:STOP (see page 368)	
:MTESt:{START STOP} (see page 686)	:RUN (see page 166) or :STOP (see page 170)	
:MTESt:TRIGger:SOURce (see page 687)	:TRIGger Commands (see page 454)	There are various commands for setting the source with different types of triggers.
:PRINt? (see page 688)	:DISPlay:DATA? (see page 238)	
:TIMebase:DELaY (see page 690)	:TIMebase:POSition (see page 445) or :TIMebase:WINDow:POSition (see page 451)	TIMebase:POSition is position value of main time base; TIMebase:WINDow:POSition is position value of zoomed (delayed) time base window.
:TRIGger:CAN:ACKnowledge (see page 691)	none	
:TRIGger:CAN:SIGNal:DEFinition (see page 692)	none	
:TRIGger:LIN:SIGNal:DEFinition (see page 693)	none	
:TRIGger:THReshold (see page 694)	:POD<n>:THReshold (see page 382) or :DIGital<n>:THReshold (see page 234)	
:TRIGger:TV:TVMode (see page 695)	:TRIGger:TV:MODE (see page 549)	

Discontinued Commands

Discontinued commands are commands that were used by previous oscilloscopes, but are not supported by the InfiniiVision 7000 Series oscilloscopes. Listed below are the Discontinued commands and the nearest equivalent command available (if any).

Discontinued Command	Current Command Equivalent	Comments
ASTore	:DISPlay:PERsistence INFinite (see page 242)	
CHANnel:MATH	:FUNctioN:OPERation (see page 264)	ADD not included

Discontinued Command	Current Command Equivalent	Comments
CHANnel<n>:PROTECT	:CHANnel<n>:PROTECTION (see page 223)	Previous form of this command was used to enable/disable 50Ω protection. The new command resets a tripped protect and the query returns the status of TRIPed or NORMal.
DISPlay:INVerse	none	
DISPlay:COLumn	none	
DISPlay:GRID	none	
DISPlay:LINE	none	
DISPlay:PIXel	none	
DISPlay:POSition	none	
DISPlay:ROW	none	
DISPlay:TEXT	none	
FUNction:MOVE	none	
FUNction:PEAKs	none	
HARDcopy:ADDRes	none	Only parallel printer port is supported. GPIB printing not supported
MASK	none	All commands discontinued, feature not available
SYSTem:KEY	none	
TEST:ALL	*TST (Self Test) (see page 129)	
TRACE subsystem	none	All commands discontinued, feature not available
TRIGger:ADVanced subsystem		Use new GLITCh, PATtern, or TV trigger modes
TRIGger:TV:FIEld	:TRIGger:TV:MODE (see page 549)	
TRIGger:TV:TVHFrej		
TRIGger:TV:VIR	none	
VAUToscale	none	

Discontinued Parameters Some previous oscilloscope queries returned control setting values of OFF and ON. The InfiniiVision 7000 Series oscilloscopes only return the enumerated values 0 (for off) and 1 (for on).

:CHANnel:ACTivity

O (see [page 740](#))

Command Syntax :CHANnel:ACTivity

The :CHANnel:ACTivity command clears the cumulative edge variables for the next activity query.

NOTE

The :CHANnel:ACTivity command is an obsolete command provided for compatibility to previous oscilloscopes. Use the :ACTivity command (see [page 134](#)) instead.

Query Syntax :CHANnel:ACTivity?

The :CHANnel:ACTivity? query returns the active edges since the last clear, and returns the current logic levels.

Return Format <edges>, <levels><NL>

<edges> ::= presence of edges (32-bit integer in NR1 format).

<levels> ::= logical highs or lows (32-bit integer in NR1 format).

NOTE

A bit equal to zero indicates that no edges were detected at the specified threshold since the last clear on that channel. Edges may have occurred that were not detected because of the threshold setting.

A bit equal to one indicates that edges have been detected at the specified threshold since the last clear on that channel.

:CHANnel:LABel

O (see [page 740](#))

Command Syntax :CHANnel:LABel <source_text><string>
 <source_text> ::= {CHANnel1 | CHANnel2 | DIGital0,...,DIGital15}
 <string> ::= quoted ASCII string

The :CHANnel:LABel command sets the source text to the string that follows. Setting a channel will also result in the name being added to the label list.

NOTE

The :CHANnel:LABel command is an obsolete command provided for compatibility to previous oscilloscopes. Use the :CHANnel<n>:LABel command (see [page 217](#)) or :DIGital<n>:LABel command (see [page 231](#)) for the InfiniiVision 7000 Series oscilloscopes.

Query Syntax :CHANnel:LABel?

The :CHANnel:LABel? query returns the label associated with a particular analog channel.

Return Format <string><NL>
 <string> ::= quoted ASCII string

:CHANnel:THReshold

O (see [page 740](#))

Command Syntax :CHANnel:THReshold <channel group>, <threshold type> [, <value>]
 <channel group> ::= {POD1 | POD2}
 <threshold type> ::= {CMOS | ECL | TTL | USERdef}
 <value> ::= voltage for USERdef in NR3 format [volt_type]
 [volt_type] ::= {V | mV (-3) | uV (-6)}

The :CHANnel:THReshold command sets the threshold for a group of channels. The threshold is either set to a predefined value or to a user-defined value. For the predefined value, the voltage parameter is ignored.

NOTE

The :CHANnel:THReshold command is an obsolete command provided for compatibility to previous oscilloscopes. Use the :POD<n>:THReshold command (see [page 382](#)) or :DIGital<n>:THReshold command (see [page 234](#)) for the InfiniiVision 7000 Series oscilloscopes.

Query Syntax :CHANnel:THReshold? <channel group>

The :CHANnel:THReshold? query returns the voltage and threshold text for a specific group of channels.

Return Format <threshold type> [, <value>]<NL>
 <threshold type> ::= {CMOS | ECL | TTL | USERdef}
 <value> ::= voltage for USERdef (float 32 NR3)

NOTE

- CMOS = 2.5V
- TTL = 1.5V
- ECL = -1.3V
- USERdef ::= -6.0V to 6.0V

:CHANnel2:SKEW

O (see [page 740](#))

Command Syntax :CHANnel2:SKEW <skew value>
 <skew value> ::= skew time in NR3 format
 <skew value> ::= -100 ns to +100 ns

The :CHANnel2:SKEW command sets the skew between channels 1 and 2. The maximum skew is +/- 100 ns. You can use the oscilloscope's analog probe skew control to remove cable delay errors between channel 1 and channel 2.

NOTE The :CHANnel2:SKEW command is an obsolete command provided for compatibility to previous oscilloscopes. Use the :CHANnel<n>:PROBe:SKEW command (see [page 221](#)) instead.

NOTE This command is only valid for the two channel oscilloscope models.

Query Syntax :CHANnel2:SKEW?

The :CHANnel2:SKEW? query returns the current probe skew setting for the selected channel.

Return Format <skew value><NL>
 <skew value> ::= skew value in NR3 format

See Also • "Introduction to :CHANnel<n> Commands" on page 210

:CHANnel<n>:INPut

O (see [page 740](#))

Command Syntax :CHANnel<n>:INPut <impedance>
<impedance> ::= {ONEMeg | FIFTy}
<n> ::= {1 | 2 | 3 | 4} for the four channel oscilloscope models
<n> ::= {1 | 2} for the two channel oscilloscope models

The :CHANnel<n>:INPut command selects the input impedance setting for the specified channel. The legal values for this command are ONEMeg (1 M Ω) and FIFTy (50 Ω).

NOTE

The :CHANnel<n>:INPut command is an obsolete command provided for compatibility to previous oscilloscopes. Use the :CHANnel<n>:IMPedance command (see [page 215](#)) instead.

Query Syntax :CHANnel<n>:INPut?

The :CHANnel<n>:INPut? query returns the current input impedance setting for the specified channel.

Return Format <impedance value><NL>
<impedance value> ::= {ONEM | FIFT}

:CHANnel<n>:PMODE

O (see [page 740](#))

Command Syntax :CHANnel<n>:PMODE <pmode value>
 <pmode value> ::= {AUTO | MANual}
 <n> ::= {1 | 2 | 3 | 4} for the four channel oscilloscope models
 <n> ::= {1 | 2} for the two channel oscilloscope models

The probe sense mode is controlled internally and cannot be set. If a probe with sense is connected to the specified channel, auto sensing is enabled; otherwise, the mode is manual.

If the PMODE sent matches the oscilloscope's setting, the command will be accepted. Otherwise, a setting conflict error is generated.

NOTE

The :CHANnel<n>:PMODE command is an obsolete command provided for compatibility to previous oscilloscopes.

Query Syntax :CHANnel<n>:PMODE?

The :CHANnel<n>:PMODE? query returns AUT if an autosense probe is attached and MAN otherwise.

Return Format <pmode value><NL>
 <pmode value> ::= {AUT | MAN}

:DISPlay:CONNect

O (see [page 740](#))

Command Syntax :DISPlay:CONNect <connect>
<connect> ::= {{ 1 | ON} | {0 | OFF}}

The :DISPlay:CONNect command turns vectors on and off. When vectors are turned on, the oscilloscope displays lines connecting sampled data points. When vectors are turned off, only the sampled data is displayed.

NOTE

The :DISPlay:CONNect command is an obsolete command provided for compatibility to previous oscilloscopes. Use the :DISPlay:VECTors command (see [page 244](#)) instead.

Query Syntax :DISPlay:CONNect?

The :DISPlay:CONNect? query returns the current state of the vectors setting.

Return Format <connect><NL>
<connect> ::= {1 | 0}

See Also • [":DISPlay:VECTors"](#) on page 244

:DISPlay:ORDer

O (see [page 740](#))

Query Syntax :DISPlay:ORDer?

The :DISPlay:ORDer? query returns a list of digital channel numbers in screen order, from top to bottom, separated by commas. Busing is displayed as digital channels with no separator. For example, in the following list, the bus consists of digital channels 4 and 5: DIG1, DIG4 DIG5, DIG7.

NOTE

The :DISPlay:ORDer command is an obsolete command provided for compatibility to previous oscilloscopes. This command is only available on the MSO models.

Return Format

```
<order><NL>
<order> ::= Unquoted ASCII string
```

NOTE

A return value is included for each digital channel. A return value of NONE indicates that a channel is turned off.

See Also • [":DIGital<n>:POSition"](#) on page 232

Example Code

```
' DISP_ORDER - Set the order the channels are displayed on the
' analyzer. You can enter between 1 and 32 channels at one time.
' If you leave out channels, they will not be displayed.

' Display ONLY channel 0 and channel 10 in that order.
myScope.WriteString ":DISPLAY:ORDER 0,10"
```

Example program from the start: ["VISA COM Example in Visual Basic"](#) on page 828

:ERASe

O (see [page 740](#))

Command Syntax :ERASe

The :ERASe command erases the screen.

NOTE

The :ERASe command is an obsolete command provided for compatibility to previous oscilloscopes. Use the :CDISplay command (see [page 141](#)) instead.

:EXternal:INPut

O (see [page 740](#))

Command Syntax :EXternal:INPut <impedance>

<impedance> ::= {ONEMeg | FIFTy}

The :EXternal:IMPedance command selects the input impedance setting for the external trigger. The legal values for this command are ONEMeg (1 M Ω) and FIFTy (50 Ω).

NOTE

The :EXternal:INPut command is an obsolete command provided for compatibility to previous oscilloscopes. Use the :EXternal:IMPedance command (see [page 248](#)) instead.

Query Syntax :EXternal:INPut?

The :EXternal:INPut? query returns the current input impedance setting for the external trigger.

Return Format <impedance value><NL>

<impedance value> ::= {ONEM | FIFT}

- See Also**
- "[Introduction to :EXternal Trigger Commands](#)" on page 245
 - "[Introduction to :TRIGger Commands](#)" on page 454
 - "[:CHANnel<n>:IMPedance](#)" on page 215

:EXternal:PMODE

O (see [page 740](#))

Command Syntax :EXternal:PMODE <pmode value>

<pmode value> ::= {AUTO | MANual}

The probe sense mode is controlled internally and cannot be set. If a probe with sense is connected to the specified channel, auto sensing is enabled; otherwise, the mode is manual.

If the pmode sent matches the oscilloscope's setting, the command will be accepted. Otherwise, a setting conflict error is generated.

NOTE

The :EXternal:PMODE command is an obsolete command provided for compatibility to previous oscilloscopes.

Query Syntax :EXternal:PMODE?

The :EXternal:PMODE? query returns AUT if an autosense probe is attached and MAN otherwise.

Return Format <pmode value><NL>

<pmode value> ::= {AUT | MAN}

:FUNCTION:SOURce

O (see [page 740](#))

Command Syntax :FUNCTION:SOURce <value>
 <value> ::= {CHANnel<n> | ADD | SUBTract | MULTiply}
 <n> ::= {1 | 2 | 3 | 4} for the four channel oscilloscope models
 <n> ::= {1 | 2} for the two channel oscilloscope models

The :FUNCTION:SOURce command is only used when an FFT (Fast Fourier Transform), DIFF, or INT operation is selected (see the:FUNCTION:OPERation command for more information about selecting an operation). The :FUNCTION:SOURce command selects the source for function operations. Choose CHANnel<n>, or ADD, SUBT, or MULT to specify the desired source for function DIFFerentiate, INTegrate, and FFT operations specified by the :FUNCTION:OPERation command.

NOTE

The :FUNCTION:SOURce command is an obsolete command provided for compatibility to previous oscilloscopes. Use the :FUNCTION:SOURce1 command (see [page 268](#)) instead.

Query Syntax :FUNCTION:SOURce?

The :FUNCTION:SOURce? query returns the current source for function operations.

Return Format <value><NL>
 <value> ::= {CHAN<n> | ADD | SUBT | MULT}
 <n> ::= {1 | 2 | 3 | 4} for the four channel oscilloscope models
 <n> ::= {1 | 2} for the two channel oscilloscope models

- See Also**
- ["Introduction to :FUNCTION Commands"](#) on page 257
 - [":FUNCTION:OPERation"](#) on page 264

:FUNCTION:VIEW

O (see [page 740](#))

Command Syntax :FUNCTION:VIEW <view>
<view> ::= {{1 | ON} | {0 | OFF}}

The :FUNCTION:VIEW command turns the selected function on or off. When ON is selected, the function performs as specified using the other FUNCTION commands. When OFF is selected, function is neither calculated nor displayed.

NOTE

The :FUNCTION:VIEW command is provided for backward compatibility to previous oscilloscopes. Use the :FUNCTION:DISPLAY command (see [page 259](#)) instead.

Query Syntax :FUNCTION:VIEW?

The :FUNCTION:VIEW? query returns the current state of the selected function.

Return Format <view><NL>
<view> ::= {1 | 0}

:HARDcopy:DESTination

O (see [page 740](#))

Command Syntax :HARDcopy:DESTination <destination>
 <destination> ::= {CENTronics | FLOppy}

The :HARDcopy:DESTination command sets the hardcopy destination.

NOTE

The :HARDcopy:DESTination command is an obsolete command provided for compatibility to previous oscilloscopes. Use the :HARDcopy:FILEname command (see [page 661](#)) instead.

Query Syntax :HARDcopy:DESTination?

The :HARDcopy:DESTination? query returns the selected hardcopy destination.

Return Format <destination><NL>
 <destination> ::= {CENT | FLOP}

- See Also**
- ["Introduction to :HARDcopy Commands"](#) on page 273
 - [":HARDcopy:FORMat"](#) on page 662

:HARDcopy:DEVICE

O (see [page 740](#))

Command Syntax :HARDcopy:DEVICE <device>
<device> ::= {TIFF | GIF | BMP | LASerjet | EPSON | DESKjet
| BWDeskJet | SEIKo}

The HARDcopy:DEVICE command sets the hardcopy device type.

NOTE

BWDeskJet option refers to the monochrome Deskjet printer.

NOTE

The :HARDcopy:DEVICE command is an obsolete command provided for compatibility to previous oscilloscopes. Use the :HARDcopy:FORMat command (see [page 662](#)) instead.

Query Syntax :HARDcopy:DEVICE?

The :HARDcopy:DEVICE? query returns the selected hardcopy device type.

Return Format <device><NL>
<device> ::= {TIFF | GIF | BMP | LAS | EPS | DESK | BWD | SEIK}

:HARDcopy:FILENAME

O (see [page 740](#))

Command Syntax :HARDcopy:FILENAME <string>
 <string> ::= quoted ASCII string

The HARDcopy:FILENAME command sets the output filename for those print formats whose output is a file.

NOTE

The :HARDcopy:FILENAME command is an obsolete command provided for compatibility to previous oscilloscopes. Use the :SAVE:FILENAME command (see [page 392](#)) and :RECall:FILENAME command (see [page 385](#)) instead.

Query Syntax :HARDcopy:FILENAME?

The :HARDcopy:FILENAME? query returns the current hardcopy output filename.

Return Format <string><NL>
 <string> ::= quoted ASCII string

- See Also**
- "[Introduction to :HARDcopy Commands](#)" on page 273
 - "[:HARDcopy:FORMat](#)" on page 662

:HARDcopy:FORMat

O (see [page 740](#))

Command Syntax :HARDcopy:FORMat <format>

```
<format> ::= {BMP[24bit] | BMP8bit | PNG | CSV | ASCiixy | BINary
             | PRINter0 | PRINter1}
```

The HARDcopy:FORMat command sets the hardcopy format type.

PRINter0 and PRINter1 are only valid when printers are connected to the oscilloscope's USB ports. (The first printer connected/identified is PRINter0 and the second is PRINter1.)

NOTE

The :HARDcopy:FORMat command is an obsolete command provided for compatibility to previous oscilloscopes. Use the :SAVE:IMAGE:FORMat (see [page 396](#)), :SAVE:WAVEform:FORMat (see [page 403](#)), and :HARDcopy:APRinter (see [page 275](#)) commands instead.

Query Syntax :HARDcopy:FORMat?

The :HARDcopy:FORMat? query returns the selected hardcopy format type.

Return Format <format><NL>

```
<format> ::= {BMP | BMP8 | PNG | CSV | ASC | BIN | PRIN0 | PRIN1}
```

See Also • ["Introduction to :HARDcopy Commands"](#) on [page 273](#)

:HARDcopy:GRAYscale

O (see [page 740](#))

Command Syntax :HARDcopy:GRAYscale <gray>
 <gray> ::= {{OFF | 0} | {ON | 1}}

The :HARDcopy:GRAYscale command controls whether grayscaling is performed in the hardcopy dump.

NOTE

The :HARDcopy:GRAYscale command is an obsolete command provided for compatibility to previous oscilloscopes. Use the :HARDcopy:PALETTE command (see [page 280](#)) instead. (":HARDcopy:GRAYscale ON" is the same as ":HARDcopy:PALETTE GRAYscale" and ":HARDcopy:GRAYscale OFF" is the same as ":HARDcopy:PALETTE COLor".)

Query Syntax :HARDcopy:GRAYscale?

The :HARDcopy:GRAYscale? query returns a flag indicating whether grayscaling is performed in the hardcopy dump.

Return Format <gray><NL>
 <gray> ::= {0 | 1}

See Also • ["Introduction to :HARDcopy Commands"](#) on page 273

:HARDcopy:IGColors

O (see [page 740](#))

Command Syntax :HARDcopy:IGColors <value>
<value> ::= {{OFF | 0} | {ON | 1}}

The HARDcopy:IGColors command controls whether the graticule colors are inverted or not.

NOTE

The :HARDcopy:IGColors command is an obsolete command provided for compatibility to previous oscilloscopes. Use the :HARDcopy:INKSaver (see [page 278](#)) command instead.

Query Syntax :HARDcopy:IGColors?

The :HARDcopy:IGColors? query returns a flag indicating whether graticule colors are inverted or not.

Return Format <value><NL>
<value> ::= {0 | 1}

See Also • ["Introduction to :HARDcopy Commands"](#) on page 273

:HARDcopy:PDRiver

O (see [page 740](#))

Command Syntax :HARDcopy:PDRiver <driver>

```
<driver> ::= {AP2Xxx | AP21xx | {AP2560 | AP25} | {DJ350 | DJ35} |
             DJ6xx | {DJ630 | DJ63} | DJ6Special | DJ6Photo |
             DJ8Special | DJ8xx | DJ9Vip | OJPRokx50 | DJ9xx | GVIP |
             DJ55xx | {PS470 | PS47} {PS100 | PS10} | CLASer |
             MLASer | LJFastraster | POSTscript}
```

The HARDcopy:PDRiver command sets the hardcopy printer driver used for the selected printer.

If the correct driver for the selected printer can be identified, it will be selected and cannot be changed.

NOTE

The :HARDcopy:PDRiver command is an obsolete command provided for compatibility to previous oscilloscopes. Use the :HARDcopy:APRinter (see [page 275](#)) command instead.

Query Syntax :HARDcopy:PDRiver?

The :HARDcopy:PDRiver? query returns the selected hardcopy printer driver.

Return Format <driver><NL>

```
<driver> ::= {AP2X | AP21 | AP25 | DJ35 | DJ6 | DJ63 | DJ6S | DJ6P |
             DJ8S | DJ8 | DJ9V | OJPR | DJ9 | GVIP | DJ55 | PS10 |
             PS47 | CLAS | MLAS | LJF | POST}
```

- See Also**
- "[Introduction to :HARDcopy Commands](#)" on page 273
 - "[:HARDcopy:FORMat](#)" on page 662

:MEASure:LOWer

O (see [page 740](#))

Command Syntax :MEASure:LOWer <voltage>

The :MEASure:LOWer command sets the lower measurement threshold value. This value and the UPPER value represent absolute values when the thresholds are ABSolute and percentage when the thresholds are PERCent as defined by the :MEASure:DEFine THResholds command.

NOTE

The :MEASure:LOWer command is obsolete and is provided for backward compatibility to previous oscilloscopes. Use the :MEASure:DEFine THResholds command (see [page 304](#)) instead.

Query Syntax :MEASure:LOWer?

The :MEASure:LOWer? query returns the current lower threshold level.

Return Format <voltage><NL>

<voltage> ::= the user-defined lower threshold in volts in NR3 format

- See Also**
- "[Introduction to :MEASure Commands](#)" on page 300
 - "[:MEASure:THResholds](#)" on page 669
 - "[:MEASure:UPPer](#)" on page 676

:MEASure:SCRatch

O (see [page 740](#))

Command Syntax :MEASure:SCRatch

The :MEASure:SCRatch command clears all selected measurements and markers from the screen.

NOTE

The :MEASure:SCRatch command is obsolete and is provided for backward compatibility to previous oscilloscopes. Use the :MEASure:CLEar command (see [page 302](#)) instead.

:MEASure:TDELta

O (see [page 740](#))

Query Syntax :MEASure:TDELta?

The :MEASure:TDELta? query returns the time difference between the Tstop marker (X2 cursor) and the Tstart marker (X1 cursor).

$Tdelta = Tstop - Tstart$

Tstart is the time at the start marker (X1 cursor) and Tstop is the time at the stop marker (X2 cursor). No measurement is made when the :MEASure:TDELta? query is received by the oscilloscope. The delta time value that is output is the current value. This is the same value as the front-panel cursors delta X value.

NOTE

The :MEASure:TDELta command is an obsolete command provided for compatibility to previous oscilloscopes. Use the :MARKer:XDELta command (see [page 290](#)) instead.

Return Format <value><NL>

<value> ::= time difference between start and stop markers in NR3 format

- See Also**
- "[Introduction to :MARKer Commands](#)" on page 284
 - "[Introduction to :MEASure Commands](#)" on page 300
 - "[:MARKer:X1Position](#)" on page 286
 - "[:MARKer:X2Position](#)" on page 288
 - "[:MARKer:XDELta](#)" on page 290
 - "[:MEASure:TSTArt](#)" on page 672
 - "[:MEASure:TSTOp](#)" on page 673

:MEASure:THResholds

O (see [page 740](#))

Command Syntax :MEASure:THResholds {T1090 | T2080 | VOLTage}

The :MEASure:THResholds command selects the thresholds used when making time measurements.

NOTE

The :MEASure:THResholds command is obsolete and is provided for backward compatibility to previous oscilloscopes. Use the :MEASure:DEFine THResholds command (see [page 304](#)) instead.

Query Syntax :MEASure:THResholds?

The :MEASure:THResholds? query returns the current thresholds selected when making time measurements.

Return Format {T1090 | T2080 | VOLTage}<NL>

{T1090} uses the 10% and 90% levels of the selected waveform.

{T2080} uses the 20% and 80% levels of the selected waveform.

{VOLTage} uses the upper and lower voltage thresholds set by the UPPER and LOWER commands on the selected waveform.

- See Also**
- ["Introduction to :MEASure Commands"](#) on page 300
 - [":MEASure:LOWer"](#) on page 666
 - [":MEASure:UPPer"](#) on page 676

:MEASure:TMAX

O (see [page 740](#))

Command Syntax :MEASure:TMAX [<source>]

<source> ::= {CHANnel<n> | FUNCTION | MATH}

<n> ::= {1 | 2 | 3 | 4} for the four channel oscilloscope models

<n> ::= {1 | 2} for the two channel oscilloscope models

The :MEASure:TMAX command installs a screen measurement and starts an X-at-Max-Y measurement on the selected waveform. If the optional source is specified, the current source is modified.

NOTE

The :MEASure:TMAX command is obsolete and is provided for backward compatibility to previous oscilloscopes. Use the :MEASure:XMAX command (see [page 344](#)) instead.

Query Syntax :MEASure:TMAX? [<source>]

The :MEASure:TMAX? query returns the horizontal axis value at which the maximum vertical value occurs on the current source. If the optional source is specified, the current source is modified. If all channels are off, the query returns 9.9E+37.

Return Format <value><NL>

<value> ::= time at maximum in NR3 format

- See Also**
- "[Introduction to :MEASure Commands](#)" on page 300
 - "[:MEASure:TMIN](#)" on page 671
 - "[:MEASure:XMAX](#)" on page 344
 - "[:MEASure:XMIN](#)" on page 345

:MEASure:TMIN

O (see [page 740](#))

Command Syntax :MEASure:TMIN [<source>]

<source> ::= {CHANnel<n> | FUNCTION | MATH}

<n> ::= {1 | 2 | 3 | 4} for the four channel oscilloscope models

<n> ::= {1 | 2} for the two channel oscilloscope models

The :MEASure:TMIN command installs a screen measurement and starts an X-at-Min-Y measurement on the selected waveform. If the optional source is specified, the current source is modified.

NOTE

The :MEASure:TMIN command is obsolete and is provided for backward compatibility to previous oscilloscopes. Use the :MEASure:XMIN command (see [page 345](#)) instead.

Query Syntax :MEASure:TMIN? [<source>]

The :MEASure:TMIN? query returns the horizontal axis value at which the minimum vertical value occurs on the current source. If the optional source is specified, the current source is modified. If all channels are off, the query returns 9.9E+37.

Return Format <value><NL>

<value> ::= time at minimum in NR3 format

- See Also**
- ["Introduction to :MEASure Commands"](#) on page 300
 - [":MEASure:TMAX"](#) on page 670
 - [":MEASure:XMAX"](#) on page 344
 - [":MEASure:XMIN"](#) on page 345

:MEASure:TSTArt

O (see [page 740](#))

Command Syntax :MEASure:TSTArt <value> [suffix]
<value> ::= time at the start marker in seconds
[suffix] ::= {s | ms | us | ns | ps}

The :MEASure:TSTArt command moves the start marker (X1 cursor) to the specified time with respect to the trigger time.

NOTE

The short form of this command, TSTA, does not follow the defined Long Form to Short Form Truncation Rules (see [page 742](#)). The normal short form "TST" would be the same for both TSTArt and TSTOp, so sending TST for the TSTArt command produces an error.

NOTE

The :MEASure:TSTArt command is an obsolete command provided for compatibility to previous oscilloscopes. Use the :MARKer:X1Position command (see [page 286](#)) instead.

Query Syntax :MEASure:TSTArt?

The :MEASure:TSTArt? query returns the time at the start marker (X1 cursor).

Return Format <value><NL>
<value> ::= time at the start marker in NR3 format

- See Also**
- "[Introduction to :MARKer Commands](#)" on page 284
 - "[Introduction to :MEASure Commands](#)" on page 300
 - "[:MARKer:X1Position](#)" on page 286
 - "[:MARKer:X2Position](#)" on page 288
 - "[:MARKer:XDELta](#)" on page 290
 - "[:MEASure:TDELta](#)" on page 668
 - "[:MEASure:TSTOP](#)" on page 673

:MEASure:TSTOp

O (see [page 740](#))

Command Syntax :MEASure:TSTOp <value> [suffix]
 <value> ::= time at the stop marker in seconds
 [suffix] ::= {s | ms | us | ns | ps}

The :MEASure:TSTOp command moves the stop marker (X2 cursor) to the specified time with respect to the trigger time.

NOTE

The short form of this command, TSTO, does not follow the defined Long Form to Short Form Truncation Rules (see [page 742](#)). The normal short form "TST" would be the same for both TSTArt and TSTOp, so sending TST for the TSTOp command produces an error.

NOTE

The :MEASure:TSTOp command is an obsolete command provided for compatibility to previous oscilloscopes. Use the :MARKer:X2Position command (see [page 288](#)) instead.

Query Syntax :MEASure:TSTOp?

The :MEASure:TSTOp? query returns the time at the stop marker (X2 cursor).

Return Format <value><NL>
 <value> ::= time at the stop marker in NR3 format

- See Also**
- ["Introduction to :MARKer Commands"](#) on page 284
 - ["Introduction to :MEASure Commands"](#) on page 300
 - [":MARKer:X1Position"](#) on page 286
 - [":MARKer:X2Position"](#) on page 288
 - [":MARKer:XDELta"](#) on page 290
 - [":MEASure:TDELta"](#) on page 668
 - [":MEASure:TSTArt"](#) on page 672

:MEASure:TVOLt

O (see [page 740](#))

Query Syntax :MEASure:TVOLt? <value>, [<slope>]<occurrence>[,<source>]

<value> ::= the voltage level that the waveform must cross.

<slope> ::= direction of the waveform. A rising slope is indicated by a plus sign (+). A falling edge is indicated by a minus sign (-).

<occurrence> ::= the transition to be reported. If the occurrence number is one, the first crossing is reported. If the number is two, the second crossing is reported, etc.

<source> ::= {<digital channels> | CHANnel<n> | FUNction | MATH}

<digital channels> ::= {DIGital0,..,DIGital15} for the MSO models

<n> ::= {1 | 2 | 3 | 4} for the four channel oscilloscope models

<n> ::= {1 | 2} for the two channel oscilloscope models

When the :MEASure:TVOLt? query is sent, the displayed signal is searched for the specified voltage level and transition. The time interval between the trigger event and this defined occurrence is returned as the response to the query.

The specified voltage can be negative or positive. To specify a negative voltage, use a minus sign (-). The sign of the slope selects a rising (+) or falling (-) edge. If no sign is specified for the slope, it is assumed to be the rising edge.

The magnitude of the occurrence defines the occurrence to be reported. For example, +3 returns the time for the third time the waveform crosses the specified voltage level in the positive direction. Once this voltage crossing is found, the oscilloscope reports the time at that crossing in seconds, with the trigger point (time zero) as the reference.

If the specified crossing cannot be found, the oscilloscope reports +9.9E+37. This value is returned if the waveform does not cross the specified voltage, or if the waveform does not cross the specified voltage for the specified number of times in the direction specified.

If the optional source parameter is specified, the current source is modified.

NOTE

The :MEASure:TVOLt command is obsolete and is provided for backward compatibility to previous oscilloscopes. Use the :MEASure:TVALue command (see [page 332](#)) for the InfiniiVision 7000 Series oscilloscopes.

Return Format <value><NL>

```
<value> ::= time in seconds of the specified voltage crossing  
           in NR3 format
```

:MEASure:UPPer

O (see [page 740](#))

Command Syntax :MEASure:UPPer <value>

The :MEASure:UPPer command sets the upper measurement threshold value. This value and the LOWer value represent absolute values when the thresholds are ABSolute and percentage when the thresholds are PERCent as defined by the :MEASure:DEFine THResholds command.

NOTE

The :MEASure:UPPer command is obsolete and is provided for backward compatibility to previous oscilloscopes. Use the :MEASure:DEFine THResholds command (see [page 304](#)) instead.

Query Syntax :MEASure:UPPer?

The :MEASure:UPPer? query returns the current upper threshold level.

Return Format <value><NL>

<value> ::= the user-defined upper threshold in NR3 format

- See Also**
- "[Introduction to :MEASure Commands](#)" on page 300
 - "[:MEASure:LOWer](#)" on page 666
 - "[:MEASure:THResholds](#)" on page 669

:MEASure:VDELta

O (see [page 740](#))

Query Syntax :MEASure:VDELta?

The :MEASure:VDELta? query returns the voltage difference between vertical marker 1 (Y1 cursor) and vertical marker 2 (Y2 cursor). No measurement is made when the :MEASure:VDELta? query is received by the oscilloscope. The delta value that is returned is the current value. This is the same value as the front-panel cursors delta Y value.

VDELta = value at marker 2 - value at marker 1

NOTE

The :MEASure:VDELta command is an obsolete command provided for compatibility to previous oscilloscopes. Use the :MARKer:YDELta command (see [page 293](#)) instead.

Return Format <value><NL>

<value> ::= delta V value in NR1 format

- See Also**
- "[Introduction to :MARKer Commands](#)" on page 284
 - "[Introduction to :MEASure Commands](#)" on page 300
 - "[:MARKer:Y1Position](#)" on page 291
 - "[:MARKer:Y2Position](#)" on page 292
 - "[:MARKer:YDELta](#)" on page 293
 - "[:MEASure:TDELta](#)" on page 668
 - "[:MEASure:TSTArt](#)" on page 672

:MEASure:VSTArt

O (see [page 740](#))

Command Syntax :MEASure:VSTArt <vstart_argument>

<vstart_argument> ::= value for vertical marker 1

The :MEASure:VSTArt command moves the vertical marker (Y1 cursor) to the specified value corresponding to the selected source. The source can be selected by the MARKer:X1Y1source command.

NOTE

The short form of this command, VSTA, does not follow the defined Long Form to Short Form Truncation Rules (see [page 742](#)). The normal short form, VST, would be the same for both VSTArt and VSTOp, so sending VST for the VSTArt command produces an error.

NOTE

The :MEASure:VSTArt command is an obsolete command provided for compatibility to previous oscilloscopes. Use the :MARKer:Y1Position command (see [page 291](#)) instead.

Query Syntax :MEASure:VSTArt?

The :MEASure:VSTArt? query returns the current value of the Y1 cursor.

Return Format <value><NL>

<value> ::= voltage at voltage marker 1 in NR3 format

- See Also**
- "[Introduction to :MARKer Commands](#)" on page 284
 - "[Introduction to :MEASure Commands](#)" on page 300
 - "[:MARKer:Y1Position](#)" on page 291
 - "[:MARKer:Y2Position](#)" on page 292
 - "[:MARKer:YDELta](#)" on page 293
 - "[:MARKer:X1Y1source](#)" on page 287
 - "[:MEASure:SOURce](#)" on page 325
 - "[:MEASure:TDELta](#)" on page 668
 - "[:MEASure:TSTArt](#)" on page 672

:MEASure:VSTOp

O (see [page 740](#))

Command Syntax :MEASure:VSTOp <vstop_argument>
 <vstop_argument> ::= value for Y2 cursor

The :MEASure:VSTOp command moves the vertical marker 2 (Y2 cursor) to the specified value corresponding to the selected source. The source can be selected by the MARKer:X2Y2source command.

NOTE The short form of this command, VSTO, does not follow the defined Long Form to Short Form Truncation Rules (see [page 742](#)). The normal short form, VST, would be the same for both VSTArt and VSTOp, so sending VST for the VSTOp command produces an error.

NOTE The :MEASure:VSTOp command is an obsolete command provided for compatibility to previous oscilloscopes. Use the :MARKer:Y2Position command (see [page 292](#)) instead.

Query Syntax :MEASure:VSTOp?

The :MEASure:VSTOp? query returns the current value of the Y2 cursor.

Return Format <value><NL>
 <value> ::= value of the Y2 cursor in NR3 format

- See Also**
- "[Introduction to :MARKer Commands](#)" on page 284
 - "[Introduction to :MEASure Commands](#)" on page 300
 - "[:MARKer:Y1Position](#)" on page 291
 - "[:MARKer:Y2Position](#)" on page 292
 - "[:MARKer:YDELta](#)" on page 293
 - "[:MARKer:X2Y2source](#)" on page 289
 - "[:MEASure:SOURce](#)" on page 325
 - "[:MEASure:TDELta](#)" on page 668
 - "[:MEASure:TSTArt](#)" on page 672

:MTESt:AMASk:{SAVE | STORe}

O (see [page 740](#))

Command Syntax :MTESt:AMASk:{SAVE | STORe} "<filename>"

The :MTESt:AMASk:SAVE command saves the automask generated mask to a file. If an automask has not been generated, an error occurs.

The <filename> parameter is an MS-DOS compatible name of the file, a maximum of 254 characters long (including the path name, if used). The filename assumes the present working directory if a path does not precede the file name.

NOTE

The :MTESt:AMASk:{SAVE | STORe} command is obsolete and is provided for backward compatibility to previous oscilloscopes. Use the :SAVE:MASK[:STARt] command (see [page 399](#)) instead.

See Also • "Introduction to :MTESt Commands" on page 348

:MTESt:AVERage

O (see [page 740](#))

Command Syntax :MTESt:AVERage <on_off>
 <on_off> ::= {{1 | ON} | {0 | OFF}}

The :MTESt:AVERage command enables or disables averaging. When ON, the oscilloscope acquires multiple data values for each time bucket, and averages them. When OFF, averaging is disabled. To set the number of averages, use the :MTESt:AVERage:COUNT command described next.

NOTE

The :MTESt:AVERage command is obsolete and is provided for backward compatibility to previous oscilloscopes. Use the :ACQuire:TYPE AVERage command (see [page 188](#)) instead.

Query Syntax :MTESt:AVERage?

The :MTESt:AVERage? query returns the current setting for averaging.

Return Format <on_off><NL>
 <on_off> ::= {1 | 0}

- See Also**
- "[Introduction to :MTESt Commands](#)" on page 348
 - "[:MTESt:AVERage:COUNT](#)" on page 682

:MTESt:AVERAge:COUNT

O (see [page 740](#))

Command Syntax :MTESt:AVERAge:COUNT <count>
<count> ::= an integer from 2 to 65536 in NR1 format

The :MTESt:AVERAge:COUNT command sets the number of averages for the waveforms. With the AVERAge acquisition type, the :MTESt:AVERAge:COUNT command specifies the number of data values to be averaged for each time bucket before the acquisition is considered complete for that time bucket.

NOTE

The :MTESt:AVERAge:COUNT command is obsolete and is provided for backward compatibility to previous oscilloscopes. Use the :ACQuire:COUNT command (see [page 177](#)) instead.

Query Syntax :MTESt:AVERAge:COUNT?

The :MTESt:AVERAge:COUNT? query returns the currently selected count value.

Return Format <count><NL>
<count> ::= an integer from 2 to 65536 in NR1 format

- See Also**
- "[Introduction to :MTESt Commands](#)" on page 348
 - "[:MTESt:AVERAge](#)" on page 681

:MTEST:LOAD

O (see [page 740](#))

Command Syntax :MTEST:LOAD "<filename>"

The :MTEST:LOAD command loads the specified mask file.

The <filename> parameter is an MS-DOS compatible name of the file, a maximum of 254 characters long (including the path name, if used).

NOTE

The :MTEST:LOAD command is obsolete and is provided for backward compatibility to previous oscilloscopes. Use the :RECall:MASK[:START] command (see [page 387](#)) instead.

- See Also**
- "Introduction to :MTEST Commands" on page 348
 - ":MTEST:AMASK:{SAVE | STORE}" on page 680

:MTESt:RUMode

O (see [page 740](#))

Command Syntax :MTESt:RUMode {FORever | TIME,<seconds> | {WAVeforms,<wfm_count>}}

<seconds> ::= from 1 to 86400 in NR3 format

<wfm_count> ::= number of waveforms in NR1 format
from 1 to 1,000,000,000

The :MTESt:RUMode command determines the termination conditions for the mask test. The choices are FORever, TIME, or WAVeforms.

- FORever – runs the Mask Test until the test is turned off.
- TIME – sets the amount of time in seconds that a mask test will run before it terminates. The <seconds> parameter is a real number from 1 to 86400 seconds.
- WAVeforms – sets the maximum number of waveforms that are required before the mask test terminates. The <wfm_count> parameter indicates the number of waveforms that are to be acquired; it is an integer from 1 to 1,000,000,000.

NOTE

The :MTESt:RUMode command is obsolete and is provided for backward compatibility to previous oscilloscopes. Use the :MTESt:RMODE command (see [page 365](#)) instead.

Query Syntax :MTESt:RUMode?

The :MTESt:RUMode? query returns the currently selected termination condition and value.

Return Format {FOR | TIME,<seconds> | {WAV,<wfm_count>}}<NL>

<seconds> ::= from 1 to 86400 in NR3 format

<wfm_count> ::= number of waveforms in NR1 format
from 1 to 1,000,000,000

- See Also**
- "[Introduction to :MTESt Commands](#)" on page 348
 - "[:MTESt:RUMode:SOFailure](#)" on page 685

:MTESt:RUMode:SOFailure

O (see [page 740](#))

Command Syntax :MTESt:RUMode:SOFailure <on_off>
 <on_off> ::= {{1 | ON} | {0 | OFF}}

The :MTESt:RUMode:SOFailure command enables or disables the Stop On Failure run until criteria. When a mask test is run and a mask violation is detected, the mask test is stopped and the acquisition system is stopped.

NOTE

The :MTESt:RUMode:SOFailure command is obsolete and is provided for backward compatibility to previous oscilloscopes. Use the :MTESt:RMODE:FACTion:STOP command (see [page 368](#)) instead.

Query Syntax :MTESt:RUMode:SOFailure?

The :MTESt:RUMode:SOFailure? query returns the current state of the Stop on Failure control.

Return Format <on_off><NL>
 <on_off> ::= {1 | 0}

- See Also**
- "[Introduction to :MTESt Commands](#)" on page 348
 - "[:MTESt:RUMode](#)" on page 684

:MTEST:{START | STOP}

O (see [page 740](#))

Command Syntax :MTEST:{START | STOP}

The :MTEST:{START | STOP} command starts or stops the acquisition system.

NOTE

The :MTEST:START and :MTEST:STOP commands are obsolete and are provided for backward compatibility to previous oscilloscopes. Use the :RUN command (see [page 166](#)) and :STOP command (see [page 170](#)) instead.

See Also • "Introduction to :MTEST Commands" on page 348

:MTESt:TRIGger:SOURce

O (see [page 740](#))

Command Syntax :MTESt:TRIGger:SOURce <source>

<source> ::= CHANnel<n>

<n> ::= {1 | 2 | 3 | 4} for the four channel oscilloscope models

<n> ::= {1 | 2} for the two channel oscilloscope models

The :MTESt:TRIGger:SOURce command sets the channel to use as the trigger.

NOTE

The :MTESt:TRIGger:SOURce command is obsolete and is provided for backward compatibility to previous oscilloscopes. Use the trigger source commands (see [page 454](#)) instead.

Query Syntax :MTESt:TRIGger:SOURce?

The :MTESt:TRIGger:SOURce? query returns the currently selected trigger source.

Return Format <source> ::= CHAN<n>

<n> ::= {1 | 2 | 3 | 4} for the four channel oscilloscope models

<n> ::= {1 | 2} for the two channel oscilloscope models

See Also • ["Introduction to :MTESt Commands"](#) on page 348

:PRINt?

O (see [page 740](#))

Query Syntax :PRINt? [<options>]

<options> ::= [<print option>][,...,<print option>]

<print option> ::= {COLor | GRAYscale | BMP8bit | BMP}

The :PRINt? query pulls image data back over the bus for storage.

NOTE

The :PRINT command is an obsolete command provided for compatibility to previous oscilloscopes. Use the :DISPlay:DATA command (see [page 238](#)) instead.

Print Option	:PRINt command	:PRINt? query	Query Default
COLor	Sets palette=COLor		
GRAYscale	Sets palette=GRAYscale		palette=COLor
PRINter0,1	Causes the USB printer #0,1 to be selected as destination (if connected)	Not used	N/A
BMP8bit	Sets print format to 8-bit BMP	Selects 8-bit BMP formatting for query	N/A
BMP	Sets print format to BMP	Selects BMP formatting for query	N/A
FACTors	Selects outputting of additional settings information for :PRINT	Not used	N/A
NOFactors	Deselects outputting of additional settings information for :PRINT	Not used	N/A

Old Print Option:	Is Now:
HIRes	COLor
LORes	GRAYscale
PARallel	PRINter0

Old Print Option:	Is Now:
DISK	invalid
PCL	invalid

NOTE

The PRINT? query is not a core command.

- See Also**
- ["Introduction to Root \(: \) Commands"](#) on page 133
 - ["Introduction to :HARDcopy Commands"](#) on page 273
 - [":HARDcopy:FORMat"](#) on page 662
 - [":HARDcopy:FACTors"](#) on page 276
 - [":HARDcopy:GRAYscale"](#) on page 663
 - [":DISPlay:DATA"](#) on page 238

:TIMEbase:DElay

O (see [page 740](#))

Command Syntax :TIMEbase:DElay <delay_value>

<delay_value> ::= time in seconds from trigger to the delay reference point on the screen.

The valid range for delay settings depends on the time/division setting for the main time base.

The :TIMEbase:DElay command sets the main time base delay. This delay is the time between the trigger event and the delay reference point on the screen. The delay reference point is set with the :TIMEbase:REference command (see [page 448](#)).

NOTE

The :TIMEbase:DElay command is obsolete and is provided for backward compatibility to previous oscilloscopes. Use the :TIMEbase:POsition command (see [page 445](#)) instead.

Query Syntax :TIMEbase:DElay?

The :TIMEbase:DElay query returns the current delay value.

Return Format <delay_value><NL>

<delay_value> ::= time from trigger to display reference in seconds in NR3 format.

Example Code

```
' TIMEBASE_DELAY - Sets the time base delay. This delay
' is the internal time between the trigger event and the
' onscreen delay reference point.

' Set time base delay to 0.0.
myScope.WriteString ":TIMEBASE:DELAY 0.0"
```

Example program from the start: "[VISA COM Example in Visual Basic](#)" on [page 828](#)

:TRIGger:CAN:ACKnowledge

O (see [page 740](#))

Command Syntax :TRIGger:CAN:ACKnowledge <value>
 <value> ::= {0 | OFF}

This command was used with the N2758A CAN trigger module for 54620/54640 Series mixed-signal oscilloscopes. The InfiniiVision 7000 Series oscilloscopes do not support the N2758A CAN trigger module.

Query Syntax :TRIGger:CAN:ACKnowledge?

The :TRIGger:CAN:ACKnowledge? query returns the current CAN acknowledge setting.

Return Format <value><NL>
 <value> ::= 0

- See Also**
- ["Introduction to :TRIGger Commands"](#) on page 454
 - [":TRIGger:MODE"](#) on page 460
 - [":TRIGger:CAN:TRIGger"](#) on page 474

:TRIGger:CAN:SIGNA:l:DEFinition

O (see [page 740](#))

Command Syntax :TRIGger:CAN:SIGNA:l:DEFinition <value>

<value> ::= {CANH | CANL | RX | TX | DIFFerential}

The :TRIGger:CAN:SIGNA:l:DEFinition command sets the CAN signal type when :TRIGger:CAN:TRIGger is set to SOF (start of frame). These signals can be set to:

Dominant high signal:

- CANH – the actual CAN_H differential bus signal.

Dominant low signals:

- CANL – the actual CAN_L differential bus signal.
- RX – the Receive signal from the CAN bus transceiver.
- TX – the Transmit signal to the CAN bus transceiver.
- DIFFerential – the CAN differential bus signal connected to an analog source channel using a differential probe.

NOTE

With InfiniiVision 7000 Series oscilloscope software version 5.00 or greater, this command is available, but the only legal value is DIFF.

Query Syntax :TRIGger:CAN:SIGNA:l:DEFinition?

The :TRIGger:CAN:SIGNA:l:DEFinition? query returns the current CAN signal type.

Return Format <value><NL>

<value> ::= DIFF

- See Also**
- "[Introduction to :TRIGger Commands](#)" on page 454
 - "[:TRIGger:MODE](#)" on page 460
 - "[:TRIGger:CAN:SIGNA:l:BAUDrate](#)" on page 472
 - "[:TRIGger:CAN:SOURce](#)" on page 473
 - "[:TRIGger:CAN:TRIGger](#)" on page 474

:TRIGger:LIN:SIGNal:DEFinition

O (see [page 740](#))

Command Syntax :TRIGger:LIN:SIGNal:DEFinition <value>
 <value> ::= {LIN | RX | TX}

The :TRIGger:LIN:SIGNal:DEFinition command sets the LIN signal type. These signals can be set to:

Dominant low signals:

- LIN – the actual LIN single-end bus signal line.
- RX – the Receive signal from the LIN bus transceiver.
- TX – the Transmit signal to the LIN bus transceiver.

NOTE

With InfiniiVision 7000 Series oscilloscope software version 5.00 or greater, this command is available, but the only legal value is LIN.

Query Syntax :TRIGger:LIN:SIGNal:DEFinition?

The :TRIGger:LIN:SIGNal:DEFinition? query returns the current LIN signal type.

Return Format <value><NL>
 <value> ::= LIN

- See Also**
- ["Introduction to :TRIGger Commands"](#) on page 454
 - [":TRIGger:MODE"](#) on page 460
 - [":TRIGger:LIN:SIGNal:BAUDrate"](#) on page 525
 - [":TRIGger:LIN:SOURce"](#) on page 526

:TRIGger:THReshold

O (see [page 740](#))

Command Syntax :TRIGger:THReshold <channel group>, <threshold type> [, <value>]
 <channel group> ::= {POD1 | POD2}
 <threshold type> ::= {CMOS | ECL | TTL | USERdef}
 <value> ::= voltage for USERdef (floating-point number) [Volt type]
 [Volt type] ::= {V | mV | uV}

The :TRIGger:THReshold command sets the threshold (trigger level) for a pod of 8 digital channels (either digital channels 0 through 7 or 8 through 15). The threshold can be set to a predefined value or to a user-defined value. For the predefined value, the voltage parameter is not required.

NOTE

This command is only available on the MSO models.

NOTE

The :TRIGger:THReshold command is an obsolete command provided for compatibility to previous oscilloscopes. Use the :POD<n>:THReshold command (see [page 382](#)), :DIGital<n>:THReshold command (see [page 234](#)), or :TRIGger[:EDGE]:LEVel command (see [page 488](#)) for the InfiniiVision 7000 Series oscilloscopes.

Query Syntax :TRIGger:THReshold? <channel group>

The :TRIGger:THReshold? query returns the voltage and threshold text for analog channel 1 or 2, or POD1 or POD2.

Return Format <threshold type>[, <value>]<NL>
 <threshold type> ::= {CMOS | ECL | TTL | USER}
 CMOS ::= 2.5V
 TTL ::= 1.5V
 ECL ::= -1.3V
 USERdef ::= range from -8.0V to +8.0V.
 <value> ::= voltage for USERdef (a floating-point number in NR1).

:TRIGger:TV:TVMode

O (see [page 740](#))

Command Syntax :TRIGger:TV:TVMode <mode>

```
<mode> ::= {FIEld1 | FIEld2 | AFIElds | ALINes | LINE | VERTical
           | LFIeld1 | LFIeld2 | LALTernate | LVERTical}
```

The :TRIGger:TV:MODE command selects the TV trigger mode and field. The LVERTical parameter is only available when :TRIGger:TV:STANdard is GENERic. The LALTernate parameter is not available when :TRIGger:TV:STANdard is GENERic (see [page 552](#)).

Old forms for <mode> are accepted:

<mode>	Old Forms Accepted
FIEld1	F1
FIEld2	F2
AFIEld	ALLFields, ALLFLDS
ALINes	ALLLines
LFIeld1	LINEF1, LINEFIELD1
LFIeld2	LINEF2, LINEFIELD2
LALTernate	LINEAlt
LVERTical	LINEVert

NOTE

The :TRIGger:TV:TVMode command is an obsolete command provided for compatibility to previous oscilloscopes. Use the :TRIGger:TV:MODE command (see [page 549](#)) instead.

Query Syntax :TRIGger:TV:TVMode?

The :TRIGger:TV:TVMode? query returns the TV trigger mode.

Return Format <value><NL>

```
<value> ::= {FIE1 | FIE2 | AFI | ALIN | LINE | VERT | LFI1 | LFI2
           | LALT | LVER}
```

7 Obsolete and Discontinued Commands

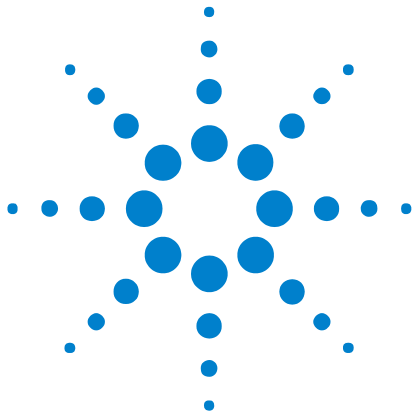

8 Error Messages

-440, Query UNTERMINATED after indefinite response

-430, Query DEADLOCKED

-420, Query UNTERMINATED

-410, Query INTERRUPTED

-400, Query error

-340, Calibration failed

-330, Self-test failed

-321, Out of memory

-320, Storage fault

-315, Configuration memory lost



-314, Save/recall memory lost

-313, Calibration memory lost

-311, Memory error

-310, System error

-300, Device specific error

-278, Macro header not found

-277, Macro redefinition not allowed

-276, Macro recursion error

-273, Illegal macro label

-272, Macro execution error

-258, Media protected

-257, File name error

-256, File name not found

-255, Directory full

-254, Media full

-253, Corrupt media

-252, Missing media

-251, Missing mass storage

-250, Mass storage error

-241, Hardware missing

This message can occur when a feature is unavailable or unlicensed.

For example, serial bus decode commands (which require a four-channel oscilloscope) are unavailable on two-channel oscilloscopes, and some serial bus decode commands are only available on four-channel oscilloscopes when the AMS (automotive serial decode) or LSS (low-speed serial decode) options are licensed.

-240, Hardware error

-231, Data questionable

-230, Data corrupt or stale

-224, Illegal parameter value

-223, Too much data

-222, Data out of range

-221, Settings conflict

-220, Parameter error

-200, Execution error

-183, Invalid inside macro definition

-181, Invalid outside macro definition

-178, Expression data not allowed

-171, Invalid expression

-170, Expression error

-168, Block data not allowed

-161, Invalid block data

-158, String data not allowed

-151, Invalid string data

-150, String data error

-148, Character data not allowed

-138, Suffix not allowed

-134, Suffix too long

-131, Invalid suffix

-128, Numeric data not allowed

-124, Too many digits

-123, Exponent too large

-121, Invalid character in number

-120, Numeric data error

-114, Header suffix out of range

-113, Undefined header

-112, Program mnemonic too long

-109, Missing parameter

-108, Parameter not allowed

-105, GET not allowed

-104, Data type error

-103, Invalid separator

-102, Syntax error

-101, Invalid character

-100, Command error

+10, Software Fault Occurred

+100, File Exists

+101, End-Of-File Found

+102, Read Error

+103, Write Error

+104, Illegal Operation

+105, Print Canceled

+106, Print Initialization Failed

+107, Invalid Trace File

+108, Compression Error

+109, No Data For Operation

+112, Unknown File Type

+113, Directory Not Supported

8 Error Messages

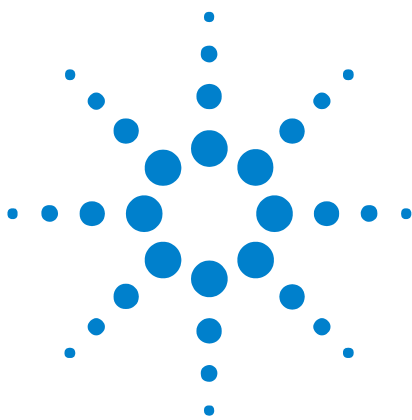

9 Status Reporting

Status Reporting Data Structures	708
Status Byte Register (STB)	711
Service Request Enable Register (SRE)	713
Trigger Event Register (TER)	714
Output Queue	715
Message Queue	716
(Standard) Event Status Register (ESR)	717
(Standard) Event Status Enable Register (ESE)	718
Error Queue	719
Operation Status Event Register (:OPERRegister[:EVENTt])	720
Operation Status Condition Register (:OPERRegister:CONDition)	721
Arm Event Register (AER)	722
Overload Event Register (:OVLRegister)	723
Hardware Event Event Register (:HWERegister[:EVENTt])	724
Hardware Event Condition Register (:HWERegister:CONDition)	725
Mask Test Event Event Register (:MTERegister[:EVENTt])	726
Clearing Registers and Queues	727
Status Reporting Decision Chart	728

IEEE 488.2 defines data structures, commands, and common bit definitions for status reporting (for example, the Status Byte Register and the Standard Event Status Register). There are also instrument-defined structures and bits (for example, the Operation Status Event Register and the Overload Event Register).

An overview of the oscilloscope's status reporting structure is shown in the following block diagram. The status reporting structure allows monitoring specified events in the oscilloscope. The ability to monitor and report these events allows determination of such things as the status of an operation, the availability and reliability of the measured data, and more.



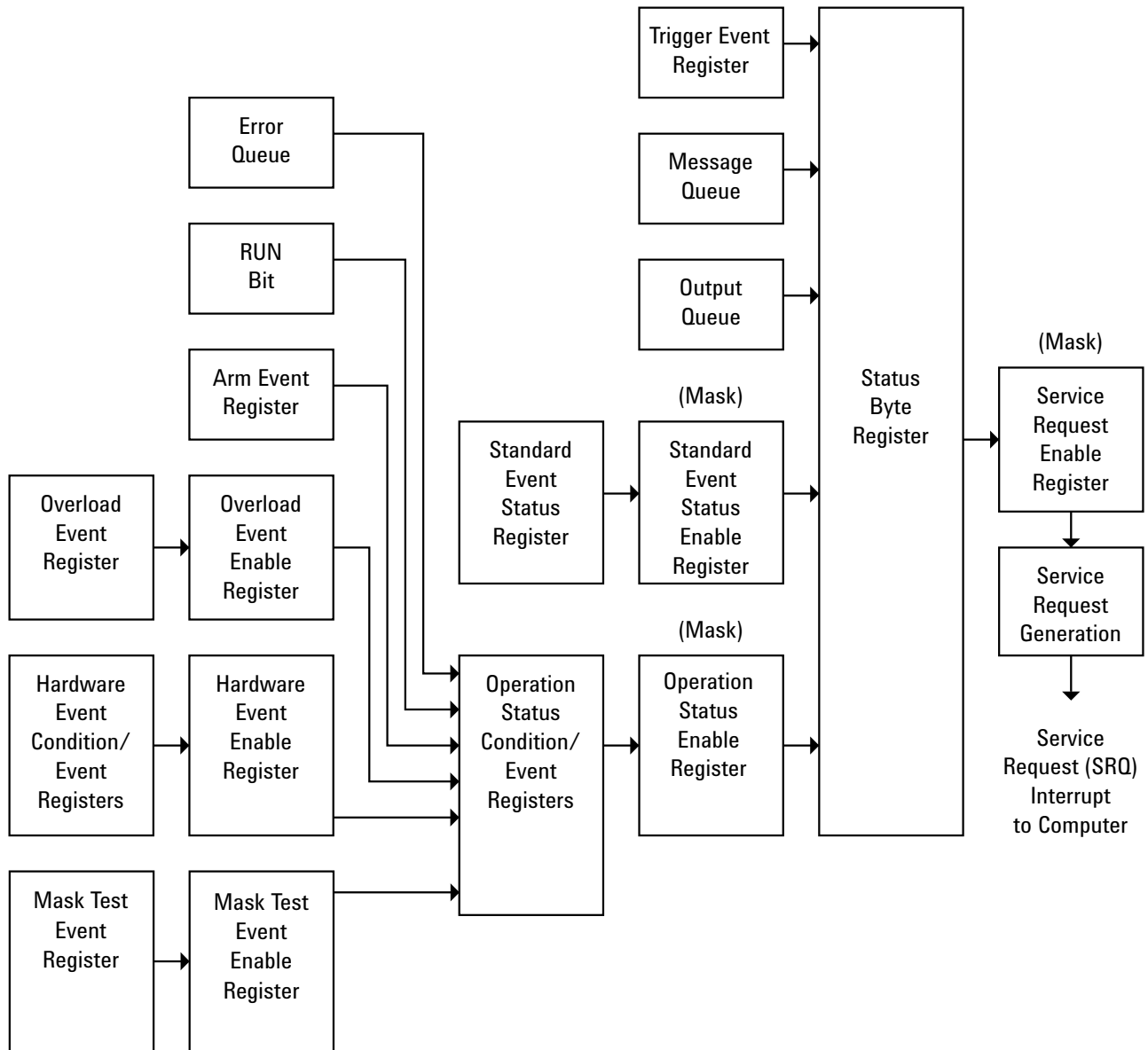

- To monitor an event, first clear the event; then, enable the event. All of the events are cleared when you initialize the instrument.
- To allow a service request (SRQ) interrupt to an external controller, enable at least one bit in the Status Byte Register (by setting, or unmasking, the bit in the Service Request Enable register).

The Status Byte Register, the Standard Event Status Register group, and the Output Queue are defined as the Standard Status Data Structure Model in IEEE 488.2-1987.

The bits in the status byte act as summary bits for the data structures residing behind them. In the case of queues, the summary bit is set if the queue is not empty. For registers, the summary bit is set if any enabled bit in the event register is set. The events are enabled with the corresponding event enable register. Events captured by an event register remain set until the register is read or cleared. Registers are read with their associated commands. The *CLS command clears all event registers and all queues except the output queue. If you send *CLS immediately after a program message terminator, the output queue is also cleared.

Status Reporting Data Structures

The following figure shows how the status register bits are masked and logically OR'ed to generate service requests (SRQ) on particular events.

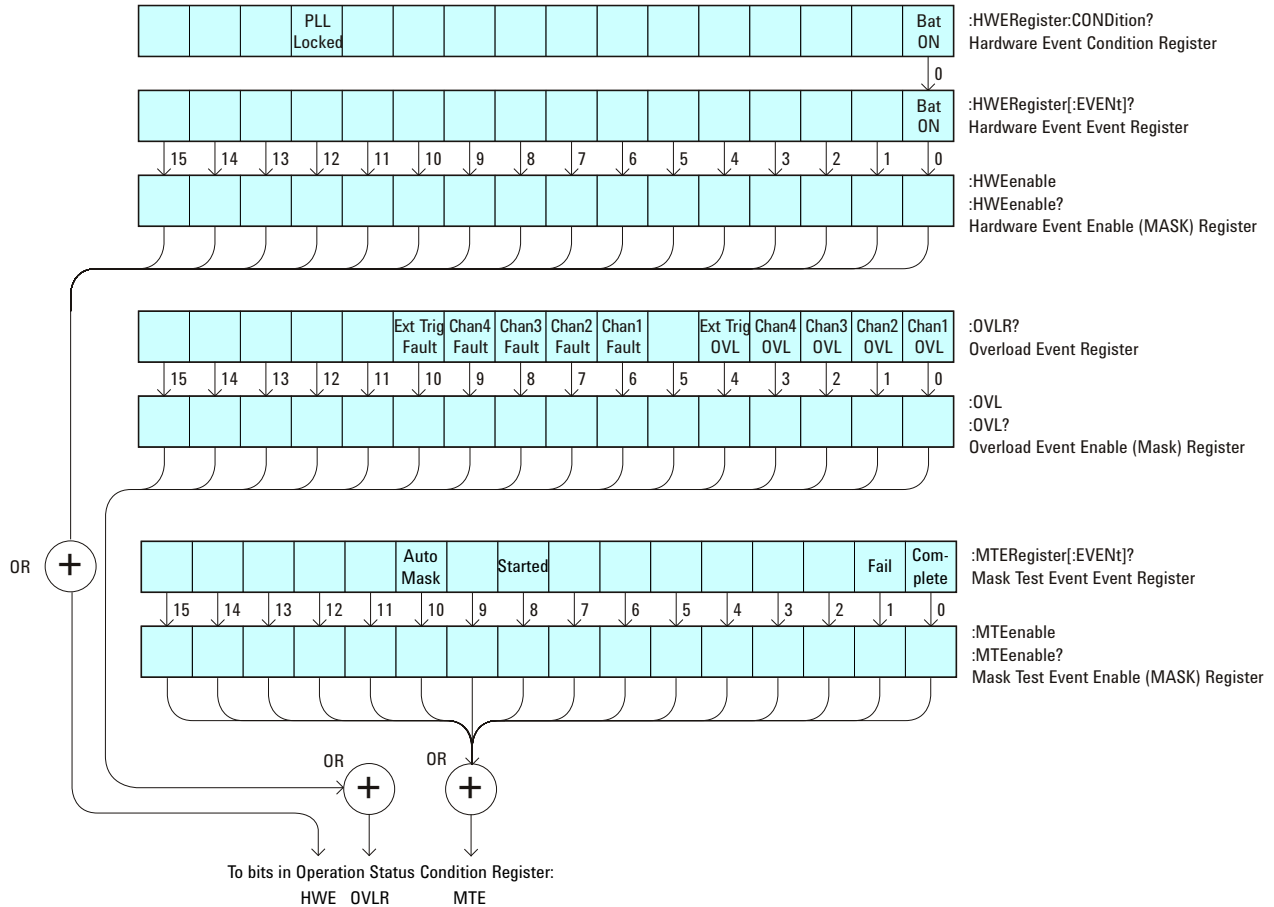

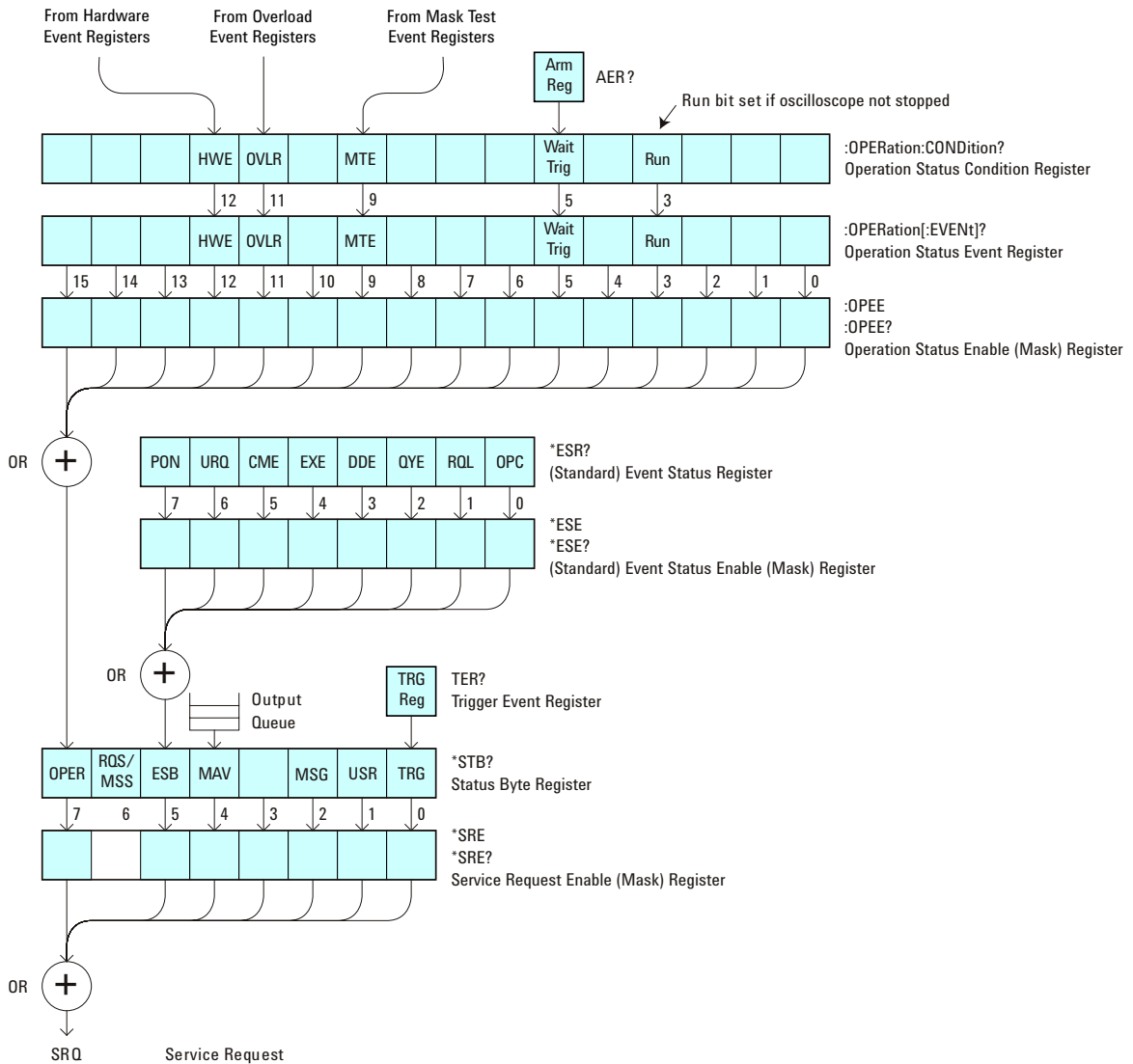

The status register bits are described in more detail in the following tables:

- "Status Byte Register (STB)" on page 126
- "Standard Event Status Register (ESR)" on page 112
- "Operation Status Condition Register" on page 157
- "Operation Status Event Register" on page 159
- "Overload Event Register (OVL)" on page 163
- "Hardware Event Condition Register" on page 146
- "Hardware Event Event Register" on page 148
- "Mask Test Event Event Register" on page 153

The status registers picture above shows how the different status reporting data structures work together. To make it possible for any of the Standard Event Status Register bits to generate a summary bit, the bits must be enabled. These bits are enabled by using the *ESE common command to set the corresponding bit in the Standard Event Status Enable Register.

To generate a service request (SRQ) interrupt to an external controller, at least one bit in the Status Byte Register must be enabled. These bits are enabled by using the *SRE common command to set the corresponding bit in the Service Request Enable Register. These enabled bits can then set RQS and MSS (bit 6) in the Status Byte Register.

Status Byte Register (STB)

The Status Byte Register is the summary-level register in the status reporting structure. It contains summary bits that monitor activity in the other status registers and queues. The Status Byte Register is a live register. That is, its summary bits are set and cleared by the presence and absence of a summary bit from other event registers or queues.

If the Status Byte Register is to be used with the Service Request Enable Register to set bit 6 (RQS/MSS) and to generate an SRQ, at least one of the summary bits must be enabled, then set. Also, event bits in all other status registers must be specifically enabled to generate the summary bit that sets the associated summary bit in the Status Byte Register.

The Status Byte Register can be read using either the *STB? Common Command or the programming interface serial poll command. Both commands return the decimal-weighted sum of all set bits in the register. The difference between the two methods is that the serial poll command reads bit 6 as the Request Service (RQS) bit and clears the bit which clears the SRQ interrupt. The *STB? command reads bit 6 as the Master Summary Status (MSS) and does not clear the bit or have any affect on the SRQ interrupt. The value returned is the total bit weights of all of the bits that are set at the present time.

The use of bit 6 can be confusing. This bit was defined to cover all possible computer interfaces, including a computer that could not do a serial poll. The important point to remember is that, if you are using an SRQ interrupt to an external computer, the serial poll command clears bit 6. Clearing bit 6 allows the oscilloscope to generate another SRQ interrupt when another enabled event occurs.

No other bits in the Status Byte Register are cleared by either the *STB? query or the serial poll, except the Message Available bit (bit 4). If there are no other messages in the Output Queue, bit 4 (MAV) can be cleared as a result of reading the response to the *STB? command.

If bit 4 (weight = 16) and bit 5 (weight = 32) are set, the program prints the sum of the two weights. Since these bits were not enabled to generate an SRQ, bit 6 (weight = 64) is not set.

The following example uses the *STB? query to read the contents of the oscilloscope's Status Byte Register.

```
myScope.WriteString "*STB?"
varQueryResult = myScope.ReadNumber
MsgBox "Status Byte Register, Read: 0x" + Hex(varQueryResult)
```

The next program prints 0xD1 and clears bit 6 (RQS) and bit 4 (MAV) of the Status Byte Register. The difference in the output value between this example and the previous one is the value of bit 6 (weight = 64). Bit 6 is set when the first enabled summary bit is set and is cleared when the Status Byte Register is read by the serial poll command.

Example The following example uses the resource session object's ReadSTB method to read the contents of the oscilloscope's Status Byte Register.

```
varQueryResult = myScope.IO.ReadSTB
MsgBox "Status Byte Register, Serial Poll: 0x" + Hex(varQueryResult)
```

NOTE

Use Serial Polling to Read Status Byte Register. Serial polling is the preferred method to read the contents of the Status Byte Register because it resets bit 6 and allows the next enabled event that occurs to generate a new SRQ interrupt.

Service Request Enable Register (SRE)

Setting the Service Request Enable Register bits enable corresponding bits in the Status Byte Register. These enabled bits can then set RQS and MSS (bit 6) in the Status Byte Register.

Bits are set in the Service Request Enable Register using the *SRE command and the bits that are set are read with the *SRE? query.

Example The following example sets bit 4 (MAV) and bit 5 (ESB) in the Service Request Enable Register.

```
myScope.WriteString "*SRE " + CStr(CInt("&H30"))
```

This example uses the decimal parameter value of 48, the string returned by CStr(CInt("&H30")), to enable the oscilloscope to generate an SRQ interrupt under the following conditions:

- When one or more bytes in the Output Queue set bit 4 (MAV).
- When an enabled event in the Standard Event Status Register generates a summary bit that sets bit 5 (ESB).

Trigger Event Register (TER)

This register sets the TRG bit in the status byte when a trigger event occurs.

The TER event register stays set until it is cleared by reading the register or using the *CLS command. If your application needs to detect multiple triggers, the TER event register must be cleared after each one.

If you are using the Service Request to interrupt a program or controller operation, you must clear the event register each time the trigger bit is set.

Output Queue

The output queue stores the oscilloscope-to-controller responses that are generated by certain instrument commands and queries. The output queue generates the Message Available summary bit when the output queue contains one or more bytes. This summary bit sets the MAV bit (bit 4) in the Status Byte Register.

When using the Agilent VISA COM library, the output queue may be read with the FormattedIO488 object's ReadString, ReadNumber, ReadList, or ReadIEEEBlock methods.

Message Queue

The message queue contains the text of the last message written to the advisory line on the screen of the oscilloscope. The length of the oscilloscope's message queue is 1. Note that messages sent with the :SYSTem:DSP command do not set the MSG status bit in the Status Byte Register.

(Standard) Event Status Register (ESR)

The (Standard) Event Status Register (ESR) monitors the following oscilloscope status events:

- PON - Power On
- URQ - User Request
- CME - Command Error
- EXE - Execution Error
- DDE - Device Dependent Error
- QYE - Query Error
- RQC - Request Control
- OPC - Operation Complete

When one of these events occur, the event sets the corresponding bit in the register. If the bits are enabled in the Standard Event Status Enable Register, the bits set in this register generate a summary bit to set bit 5 (ESB) in the Status Byte Register.

You can read the contents of the Standard Event Status Register and clear the register by sending the *ESR? query. The value returned is the total bit weights of all of the bits that are set at the present time.

Example The following example uses the *ESR query to read the contents of the Standard Event Status Register.

```
myScope.WriteString "*ESR?"
varQueryResult = myScope.ReadNumber
MsgBox "Standard Event Status Register: 0x" + Hex(varQueryResult)
```

If bit 4 (weight = 16) and bit 5 (weight = 32) are set, the program prints the sum of the two weights.

(Standard) Event Status Enable Register (ESE)

To allow any of the (Standard) Event Status Register (ESR) bits to generate a summary bit, you must first enable that bit. Enable the bit by using the *ESE (Event Status Enable) common command to set the corresponding bit in the (Standard) Event Status Enable Register (ESE).

Set bits are read with the *ESE? query.

Example Suppose your application requires an interrupt whenever any type of error occurs. The error related bits in the (Standard) Event Status Register are bits 2 through 5 (hexadecimal value 0x3C). Therefore, you can enable any of these bits to generate the summary bit by sending:

```
myScope.WriteString "*ESE " + CStr(CInt("&H3C"))
```

Whenever an error occurs, it sets one of these bits in the (Standard) Event Status Register. Because all the error related bits are enabled, a summary bit is generated to set bit 5 (ESB) in the Status Byte Register.

If bit 5 (ESB) in the Status Byte Register is enabled (via the *SRE command), an SRQ service request interrupt is sent to the controller PC.

NOTE

Disabled (Standard) Event Status Register bits respond but do not generate a summary bit. (Standard) Event Status Register bits that are not enabled still respond to their corresponding conditions (that is, they are set if the corresponding event occurs). However, because they are not enabled, they do not generate a summary bit to the Status Byte Register.

Error Queue

As errors are detected, they are placed in an error queue. This queue is first in, first out. If the error queue overflows, the last error in the queue is replaced with error 350, Queue overflow. Any time the queue overflows, the least recent errors remain in the queue, and the most recent error is discarded. The length of the oscilloscope's error queue is 30 (29 positions for the error messages, and 1 position for the Queue overflow message).

The error queue is read with the `:SYSTEM:ERROR?` query. Executing this query reads and removes the oldest error from the head of the queue, which opens a position at the tail of the queue for a new error. When all the errors have been read from the queue, subsequent error queries return "0, No error".

The error queue is cleared when:

- the instrument is powered up,
- the instrument receives the `*CLS` common command, or
- the last item is read from the error queue.

Operation Status Event Register (:OPERRegister[:EVENTt])

The Operation Status Event Register register hosts these bits:

Name	Location	Description
RUN bit	bit 3	Is set whenever the instrument goes from a stop state to a single or running state.
WAIT TRIG bit	bit 5	Is set by the Trigger Armed Event Register and indicates that the trigger is armed.
MTE bit	bit 9	Comes from the Mask Test Event Registers.
OVLRL bit	bit 11	Is set whenever a 50Ω input overload occurs.
HWE bit	bit 12	Comes from the Hardware Event Registers.

If any of these bits are set, the OPER bit (bit 7) of the Status Byte Register is set. The Operation Status Event Register is read and cleared with the :OPERRegister[:EVENTt]? query. The register output is enabled or disabled using the mask value supplied with the OPEE command.

Operation Status Condition Register (:OPERegister:CONDition)

The Operation Status Condition Register register hosts these bits:

Name	Location	Description
RUN bit	bit 3	Is set whenever the instrument is not stopped.
WAIT TRIG bit	bit 5	Is set by the Trigger Armed Event Register and indicates that the trigger is armed.
MTE bit	bit 9	Comes from the Mask Test Event Registers.
OVLr bit	bit 11	Is set whenever a 50 Ω input overload occurs.
HWE bit	bit 12	Comes from the Hardware Event Registers.

The :OPERegister:CONDition? query returns the value of the Operation Status Condition Register.

Arm Event Register (AER)

This register sets bit 5 (Wait Trig bit) in the Operation Status Register and the OPER bit (bit 7) in the Status Byte Register when the instrument becomes armed.

The ARM event register stays set until it is cleared by reading the register with the AER? query or using the *CLS command. If your application needs to detect multiple triggers, the ARM event register must be cleared after each one.

If you are using the Service Request to interrupt a program or controller operation when the trigger bit is set, then you must clear the event register after each time it has been set.

Overload Event Register (:OVLRegister)

The Overload Event Register register hosts these bits:

Name	Location	Description
Channel 1 OVL	bit 0	Overload has occurred on Channel 1 input.
Channel 2 OVL	bit 1	Overload has occurred on Channel 2 input.
Channel 3 OVL	bit 2	Overload has occurred on Channel 3 input.
Channel 4 OVL	bit 3	Overload has occurred on Channel 4 input.
External Trigger OVL	bit 4	Overload has occurred on External Trigger input.
Channel 1 Fault	bit 6	Fault has occurred on Channel 1 input.
Channel 2 Fault	bit 7	Fault has occurred on Channel 2 input.
Channel 3 Fault	bit 8	Fault has occurred on Channel 3 input.
Channel 4 Fault	bit 9	Fault has occurred on Channel 4 input.
External Trigger Fault	bit 10	Fault has occurred on External Trigger input.

Hardware Event Register (:HWERegister[:EVENT])

This register hosts the Bat On bit (bit 0).

- The Bat On bit is set whenever the instrument is operating on battery power.

Hardware Event Condition Register (:HWERegister:CONDition)

This register hosts the Bat On bit (bit 0) and the PLL LOCKED bit (bit 12).

- The :HWERegister:CONDition? query returns the value of the Hardware Event Condition Register.
- The PLL LOCKED bit (bit 12) is for internal use and is not intended for general use.
- The Bat On bit is set whenever the instrument is operating on battery power.

Mask Test Event Event Register (:MTERegister[:EVENT])

The Mask Test Event Event Register register hosts these bits:

Name	Location	Description
Complete	bit 0	Is set when the mask test is complete.
Fail	bit 1	Is set when there is a mask test failure.
Started	bit 8	Is set when mask testing is started.
Auto Mask	bit 10	Is set when auto mask creation is completed.

The :MTERegister[:EVENT]? query returns the value of, and clears, the Mask Test Event Event Register.

Clearing Registers and Queues

The *CLS common command clears all event registers and all queues except the output queue. If *CLS is sent immediately after a program message terminator, the output queue is also cleared.

Status Reporting Decision Chart

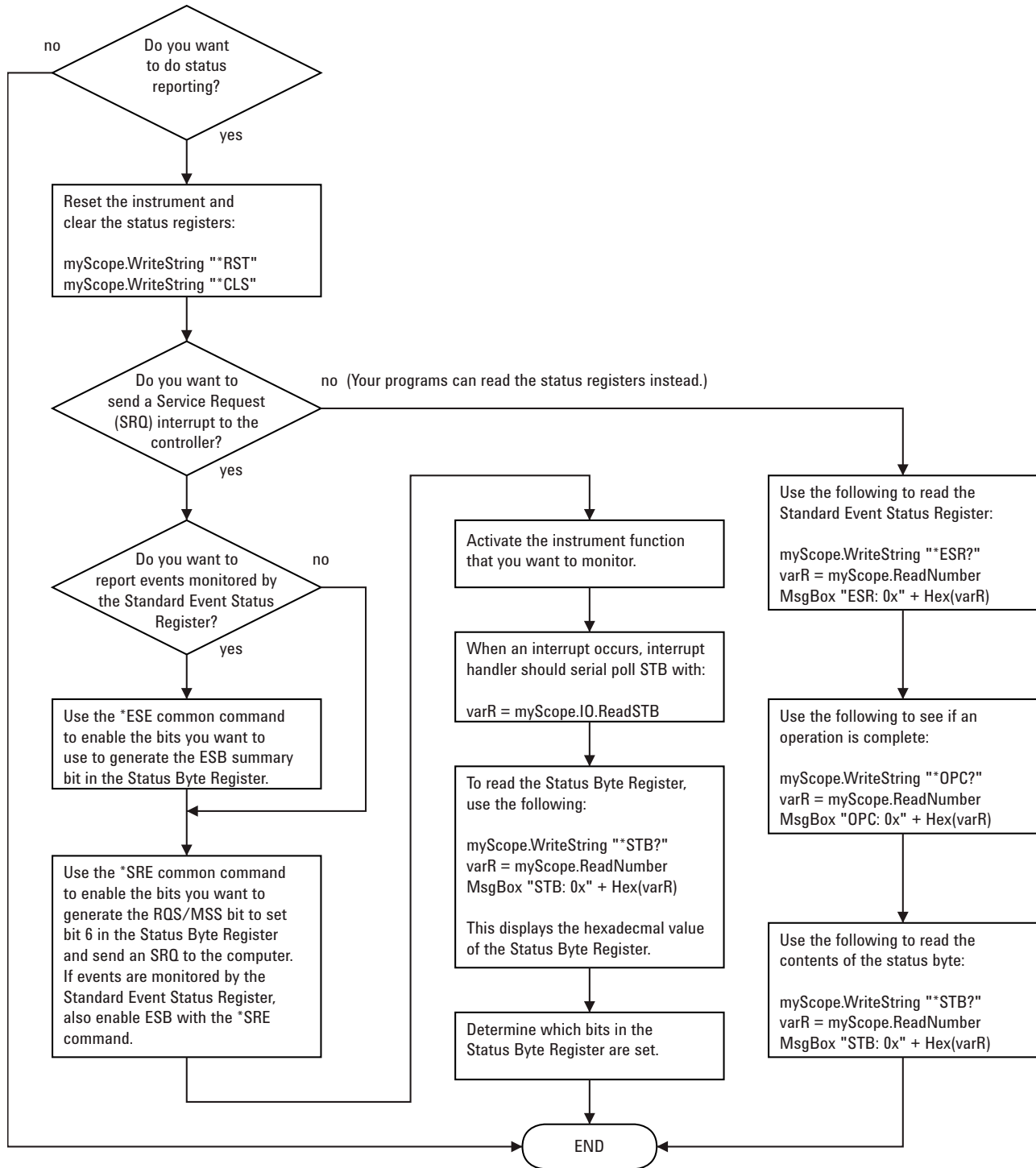

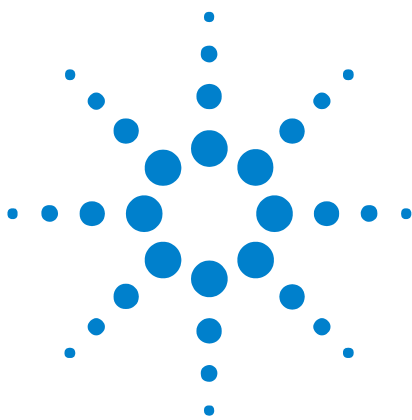

10 Synchronizing Acquisitions

- Synchronization in the Programming Flow [730](#)
- Blocking Synchronization [731](#)
- Polling Synchronization With Timeout [732](#)
- Synchronizing with a Single-Shot Device Under Test (DUT) [734](#)
- Synchronization with an Averaging Acquisition [736](#)

When remotely controlling an oscilloscope with programming commands, it is often necessary to know when the oscilloscope has finished the previous operation and is ready for the next command. The most common example is when an acquisition is started using the `:DIGitize`, `:RUN`, or `:SINGLE` commands. Before a measurement result can be queried, the acquisition must complete. Too often fixed delays are used to accomplish this wait, but fixed delays often use excessive time or the time may not be long enough. A better solution is to use synchronous commands and status to know when the oscilloscope is ready for the next request.



Synchronization in the Programming Flow

Most remote programming follows these three general steps:

- 1 Set up the oscilloscope and device under test (see [page 730](#)).
- 2 Acquire a waveform (see [page 730](#)).
- 3 Retrieve results (see [page 730](#)).

Set Up the Oscilloscope

Before making changes to the oscilloscope setup, it is best to make sure it is stopped using the :STOP command followed by the *OPC? query.

NOTE

It is not necessary to use *OPC?, hard coded waits, or status checking when setting up the oscilloscope. After the oscilloscope is configured, it is ready for an acquisition.

Acquire a Waveform

When acquiring a waveform there are two possible methods used to wait for the acquisition to complete. These methods are blocking and polling. The table below details when each method should be chosen and why.

	Blocking Wait	Polling Wait
Use When	You know the oscilloscope <i>will</i> trigger based on the oscilloscope setup and device under test.	You know the oscilloscope <i>may or may not</i> trigger on the oscilloscope setup and device under test.
Advantages	No need for polling. Fastest method.	Remote interface will not timeout No need for device clear if no trigger.
Disadvantages	Remote interface may timeout. Device clear only way to get control of oscilloscope if there is no trigger.	Slower method. Requires polling loop. Requires known maximum wait time.
Implementation Details	See " Blocking Synchronization " on page 731.	See " Polling Synchronization With Timeout " on page 732.

Retrieve Results

Once the acquisition is complete, it is safe to retrieve measurements and statistics.

Blocking Synchronization

Use the :DIGitize command to start the acquisition. This blocks subsequent queries until the acquisition and processing is complete. For example:

```
'
' Synchronizing acquisition using blocking.
' =====

Option Explicit

Public myMgr As VisaComLib.ResourceManager
Public myScope As VisaComLib.FormattedIO488
Public varQueryResult As Variant
Public strQueryResult As String

Sub Main()

    On Error GoTo VisaComError

    ' Create the VISA COM I/O resource.
    Set myMgr = New VisaComLib.ResourceManager
    Set myScope = New VisaComLib.FormattedIO488
    Set myScope.IO = myMgr.Open("TCPIP0::130.29.69.12::inst0::INSTR")
    myScope.IO.Clear ' Clear the interface.

    ' Set up.
    ' -----
    myScope.WriteString ":TRIGger:MODE EDGE"
    myScope.WriteString ":TRIGger:EDGE:LEVEl 2"
    myScope.WriteString ":TIMEbase:SCALE 5e-8"

    ' Acquire.
    ' -----
    myScope.WriteString ":DIGitize"

    ' Get results.
    ' -----
    myScope.WriteString ":MEASure:RISetime"
    myScope.WriteString ":MEASure:RISetime?"
    varQueryResult = myScope.ReadNumber ' Read risetime.
    Debug.Print "Risetime: " + _
        FormatNumber(varQueryResult * 1000000000, 1) + " ns"

    Exit Sub

VisaComError:
    MsgBox "VISA COM Error:" + vbCrLf + Err.Description

End Sub
```

Polling Synchronization With Timeout

This example requires a timeout value so the operation can abort if an acquisition does not occur within the timeout period:

```
'
' Synchronizing acquisition using polling.
' =====

Option Explicit

Public myMgr As VisaComLib.ResourceManager
Public myScope As VisaComLib.FormattedIO488
Public varQueryResult As Variant
Public strQueryResult As String

Private Declare Sub Sleep Lib "kernel32" (ByVal dwMilliseconds As Long)

Sub Main()

    On Error GoTo VisaComError

    ' Create the VISA COM I/O resource.
    Set myMgr = New VisaComLib.ResourceManager
    Set myScope = New VisaComLib.FormattedIO488
    Set myScope.IO = myMgr.Open("TCPIP0::130.29.69.12::inst0::INSTR")
    myScope.IO.Clear    ' Clear the interface.

    ' Set up.
    ' -----
    ' Set up the trigger and horizontal scale.
    myScope.WriteString ":TRIGger:MODE EDGE"
    myScope.WriteString ":TRIGger:EDGE:LEVel 2"
    myScope.WriteString ":TIMEbase:SCALE 5e-8"

    ' Stop acquisitions and wait for the operation to complete.
    myScope.WriteString ":STOP"
    myScope.WriteString "*OPC?"
    strQueryResult = myScope.ReadString

    ' Acquire.
    ' -----
    ' Start a single acquisition.
    myScope.WriteString ":SINGLE"

    ' Oscilloscope is armed and ready, enable DUT here.
    Debug.Print "Oscilloscope is armed and ready, enable DUT."

    ' Look for RUN bit = stopped (acquisition complete).
    Dim lngTimeout As Long    ' Max millisecs to wait for single-shot.
    Dim lngElapsed As Long
    lngTimeout = 10000    ' 10 seconds.
    lngElapsed = 0

    Do While lngElapsed <= lngTimeout
```

```

myScope.WriteString ":OPERRegister:CONDition?"
varQueryResult = myScope.ReadNumber
' Mask RUN bit (bit 3, &H8).
If (varQueryResult And &H8) = 0 Then
    Exit Do
Else
    Sleep 100 ' Small wait to prevent excessive queries.
    lngElapsed = lngElapsed + 100
End If
Loop

' Get results.
' -----
If lngElapsed < lngTimeout Then
    myScope.WriteString ":MEASure:RISetime"
    myScope.WriteString ":MEASure:RISetime?"
    varQueryResult = myScope.ReadNumber ' Read risetime.
    Debug.Print "Risetime: " + _
        FormatNumber(varQueryResult * 1000000000, 1) + " ns"
Else
    Debug.Print "Timeout waiting for single-shot trigger."
End If

Exit Sub

VisaComError:
    MsgBox "VISA COM Error:" + vbCrLf + Err.Description

End Sub

```

Synchronizing with a Single-Shot Device Under Test (DUT)

The examples in "[Blocking Synchronization](#)" on page 731 and "[Polling Synchronization With Timeout](#)" on page 732 assume the DUT is continually running and therefore the oscilloscope will have more than one opportunity to trigger. With a single shot DUT, there is only one opportunity for the oscilloscope to trigger, so it is necessary for the oscilloscope to be armed and ready before the DUT is enabled.

NOTE

The blocking :DIGitize command cannot be used for a single shot DUT because once the :DIGitize command is issued, the oscilloscope is blocked from any further commands until the acquisition is complete.

This example is the same "[Polling Synchronization With Timeout](#)" on page 732 with the addition of checking for the armed event status.

```
'
' Synchronizing single-shot acquisition using polling.
' =====

Option Explicit

Public myMgr As VisaComLib.ResourceManager
Public myScope As VisaComLib.FormattedIO488
Public varQueryResult As Variant
Public strQueryResult As String

Private Declare Sub Sleep Lib "kernel32" (ByVal dwMilliseconds As Long)

Sub Main()

    On Error GoTo VisaComError

    ' Create the VISA COM I/O resource.
    Set myMgr = New VisaComLib.ResourceManager
    Set myScope = New VisaComLib.FormattedIO488
    Set myScope.IO = myMgr.Open("TCPIP0::130.29.69.12::inst0::INSTR")
    myScope.IO.Clear ' Clear the interface.

    ' Set up.
    ' -----

    ' Set up the trigger and horizontal scale.
    myScope.WriteString ":TRIGger:MODE EDGE"
    myScope.WriteString ":TRIGger:EDGE:LEVel 2"
    myScope.WriteString ":TIMEbase:SCALE 5e-8"

    ' Stop acquisitions and wait for the operation to complete.
    myScope.WriteString ":STOP"
    myScope.WriteString "*OPC?"
    strQueryResult = myScope.ReadString

    ' Acquire.
```

```

' -----
' Start a single acquisition.
myScope.WriteString ":SINGLE"

' Wait until the trigger system is armed.
Do
  Sleep 100 ' Small wait to prevent excessive queries.
  myScope.WriteString ":AER?"
  varQueryResult = myScope.ReadNumber
Loop Until varQueryResult = 1

' Oscilloscope is armed and ready, enable DUT here.
Debug.Print "Oscilloscope is armed and ready, enable DUT."

' Now, look for RUN bit = stopped (acquisition complete).
Dim lngTimeout As Long ' Max millisecs to wait for single-shot.
Dim lngElapsed As Long
lngTimeout = 10000 ' 10 seconds.
lngElapsed = 0

Do While lngElapsed <= lngTimeout
  myScope.WriteString ":OPERRegister:CONdition?"
  varQueryResult = myScope.ReadNumber
  ' Mask RUN bit (bit 3, &H8).
  If (varQueryResult And &H8) = 0 Then
    Exit Do
  Else
    Sleep 100 ' Small wait to prevent excessive queries.
    lngElapsed = lngElapsed + 100
  End If
Loop

' Get results.
' -----
If lngElapsed < lngTimeout Then
  myScope.WriteString ":MEASure:RISetime"
  myScope.WriteString ":MEASure:RISetime?"
  varQueryResult = myScope.ReadNumber ' Read risetime.
  Debug.Print "Risetime: " + _
    FormatNumber(varQueryResult * 1000000000, 1) + " ns"
Else
  Debug.Print "Timeout waiting for single-shot trigger."
End If

Exit Sub

VisaComError:
  MsgBox "VISA COM Error:" + vbCrLf + Err.Description

End Sub

```

Synchronization with an Averaging Acquisition

When averaging, it is necessary to know when the average count has been reached. The :SINGLe command does not average.

If it is known that a trigger will occur, a :DIGitize will acquire the complete number of averages, but if the number of averages is large, a timeout on the connection can occur.

The example below polls during the :DIGitize to prevent a timeout on the connection.

```
'
' Synchronizing in averaging acquisition mode.
' =====

Option Explicit

Public myMgr As VisaComLib.ResourceManager
Public myScope As VisaComLib.FormattedIO488
Public varQueryResult As Variant
Public strQueryResult As String

Private Declare Sub Sleep Lib "kernel32" (ByVal dwMilliseconds As Long)

Sub Main()

    On Error GoTo VisaComError

    ' Create the VISA COM I/O resource.
    Set myMgr = New VisaComLib.ResourceManager
    Set myScope = New VisaComLib.FormattedIO488
    Set myScope.IO = myMgr.Open("TCPIP0::130.29.69.12::inst0::INSTR")
    myScope.IO.Clear ' Clear the interface.
    myScope.IO.Timeout = 5000

    ' Set up.
    ' -----
    ' Set up the trigger and horizontal scale.
    myScope.WriteString ":TRIGger:SWEEp NORMal"
    myScope.WriteString ":TRIGger:MODE EDGE"
    myScope.WriteString ":TRIGger:EDGE:LEVel 2"
    myScope.WriteString ":TIMEbase:SCALE 5e-8"

    ' Stop acquisitions and wait for the operation to complete.
    myScope.WriteString ":STOP"
    myScope.WriteString "*OPC?"
    strQueryResult = myScope.ReadString

    ' Set up average acquisition mode.
    Dim lngAverages As Long
    lngAverages = 256
    myScope.WriteString ":ACquire:COUNT " + CStr(lngAverages)
    myScope.WriteString ":ACquire:TYPE AVERAge"
```



```

' Save *ESE (Standard Event Status Enable register) mask
' (so it can be restored later).
Dim varInitialESE As Variant
myScope.WriteString "*ESE?"
varInitialESE = myScope.ReadNumber

' Set *ESE mask to allow only OPC (Operation Complete) bit.
myScope.WriteString "*ESE " + CStr(CInt("&H01"))

' Acquire using :DIGitize. Set up OPC bit to be set when the
' operation is complete.
' -----
myScope.WriteString ":DIGitize"
myScope.WriteString "*OPC"

' Assume the oscilloscope will trigger, if not put a check here.

' Wait until OPC becomes true (bit 5 of Status Byte register, STB,
' from Standard Event Status register, ESR, is set). STB can be
' read during :DIGitize without generating a timeout.
Do
Sleep 4000 ' Poll more often than the timeout setting.
varQueryResult = myScope.IO.ReadSTB
Loop While (varQueryResult And &H20) = 0

' Clear ESR and restore previously saved *ESE mask.
myScope.WriteString "*ESR?" ' Clear ESR by reading it.
varQueryResult = myScope.ReadNumber
myScope.WriteString "*ESE " + CStr(varInitialESE)

' Get results.
' -----
myScope.WriteString ":WAVEform:COUNT?"
varQueryResult = myScope.ReadNumber
Debug.Print "Averaged waveforms: " + CStr(varQueryResult)

myScope.WriteString ":MEASure:RISetime"
myScope.WriteString ":MEASure:RISetime?"
varQueryResult = myScope.ReadNumber ' Read risetime.
Debug.Print "Risetime: " + _
FormatNumber(varQueryResult * 1000000000, 1) + " ns"

Exit Sub

VisaComError:
MsgBox "VISA COM Error:" + vbCrLf + Err.Description

End Sub

```

10 Synchronizing Acquisitions



11

More About Oscilloscope Commands

- Command Classifications [740](#)
- Valid Command/Query Strings [741](#)
- Query Return Values [761](#)
- All Oscilloscope Commands Are Sequential [762](#)



Command Classifications

To help you use existing programs with your oscilloscope, or use current programs with the next generation of Agilent InfiniiVision oscilloscopes, commands are classified by the following categories:

- ["Core Commands"](#) on page 740
- ["Non-Core Commands"](#) on page 740
- ["Obsolete Commands"](#) on page 740

C Core Commands

Core commands are a common set of commands that provide basic oscilloscope functionality on this oscilloscope and future Agilent InfiniiVision oscilloscopes. Core commands are unlikely to be modified in the future. If you restrict your programs to core commands, the programs should work across product offerings in the future, assuming appropriate programming methods are employed.

N Non-Core Commands

Non-core commands are commands that provide specific features, but are not universal across all Agilent InfiniiVision oscilloscope models. Non-core commands may be modified or deleted in the future. With a command structure as complex as the one for your oscilloscope, some evolution over time is inevitable. Agilent's intent is to continue to expand command subsystems, such as the rich and evolving trigger feature set.

O Obsolete Commands

Obsolete commands are older forms of commands that are provided to reduce customer rework for existing systems and programs. Generally, these commands are mapped onto some of the Core and Non-core commands, but may not strictly have the same behavior as the new command. None of the obsolete commands are guaranteed to remain functional in future products. New systems and programs should use the Core (and Non-core) commands. Obsolete commands are listed in:

- ["Obsolete and Discontinued Commands"](#) on page 641
- As well as: ["Commands A-Z"](#) on page 609

Valid Command/Query Strings

- "Program Message Syntax" on page 741
- "Command Tree" on page 745
- "Duplicate Mnemonics" on page 758
- "Tree Traversal Rules and Multiple Commands" on page 759

Program Message Syntax

To program the instrument remotely, you must understand the command format and structure expected by the instrument. The IEEE 488.2 syntax rules govern how individual elements such as headers, separators, program data, and terminators may be grouped together to form complete instructions. Syntax definitions are also given to show how query responses are formatted. The following figure shows the main syntactical parts of a typical program statement.

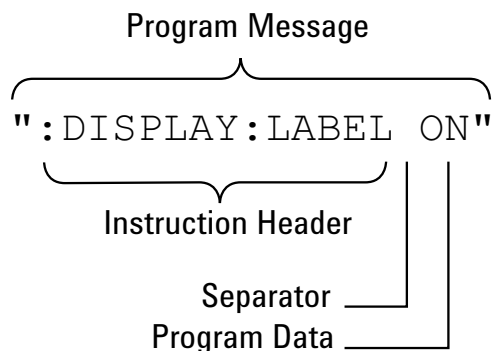

Instructions (both commands and queries) normally appear as a string embedded in a statement of your host language, such as Visual Basic or C/C++. The only time a parameter is not meant to be expressed as a string is when the instruction's syntax definition specifies <block data>, such as <learn string>. There are only a few instructions that use block data.

Program messages can have long or short form commands (and data in some cases – see "Long Form to Short Form Truncation Rules" on page 742), and upper and/or lower case ASCII characters may be used. (Query responses, however, are always returned in upper case.)

Instructions are composed of two main parts:

- The header, which specifies the command or query to be sent.
- The program data, which provide additional information needed to clarify the meaning of the instruction.

Instruction Header The instruction header is one or more mnemonics separated by colons (:) that represent the operation to be performed by the instrument. The "Command Tree" on page 745 illustrates how all the mnemonics can be joined together to form a complete header.

":DISPlay:LABel ON" is a command. Queries are indicated by adding a question mark (?) to the end of the header, for example, ":DISPlay:LABel?". Many instructions can be used as either commands or queries, depending on whether or not you have included the question mark. The command and query forms of an instruction usually have different program data. Many queries do not use any program data.

There are three types of headers:

- "Simple Command Headers" on page 743
- "Compound Command Headers" on page 743
- "Common Command Headers" on page 744

White Space (Separator) White space is used to separate the instruction header from the program data. If the instruction does not require any program data parameters, you do not need to include any white space. White space is defined as one or more space characters. ASCII defines a space to be character 32 (in decimal).

Program Data Program data are used to clarify the meaning of the command or query. They provide necessary information, such as whether a function should be on or off, or which waveform is to be displayed. Each instruction's syntax definition shows the program data, as well as the values they accept. "Program Data Syntax Rules" on page 744 describes all of the general rules about acceptable values.

When there is more than one data parameter, they are separated by commas(.). Spaces can be added around the commas to improve readability.

Program Message Terminator The program instructions within a data message are executed after the program message terminator is received. The terminator may be either an NL (New Line) character, an EOI (End-Or-Identify) asserted in the programming interface, or a combination of the two. Asserting the EOI sets the EOI control line low on the last byte of the data message. The NL character is an ASCII linefeed (decimal 10).

NOTE

New Line Terminator Functions. The NL (New Line) terminator has the same function as an EOS (End Of String) and EOT (End Of Text) terminator.

Long Form to Short Form Truncation Rules

To get the short form of a command/keyword:

- When the command/keyword is longer than four characters, use the first four characters of the command/keyword unless the fourth character is a vowel; when the fourth character is a vowel, use the first three characters of the command/keyword.
- When the command/keyword is four or fewer characters, use all of the characters.

Long Form	Short form
RANGe	RANG
PATTerN	PATT
TIMebase	TIM
DELay	DEL
TYPE	TYPE

In the oscilloscope programmer's documentation, the short form of a command is indicated by uppercase characters.

Programs written in long form are easily read and are almost self-documenting. The short form syntax conserves the amount of controller memory needed for program storage and reduces I/O activity.

Simple Command Headers

Simple command headers contain a single mnemonic. :AUToscale and :DIGitize are examples of simple command headers typically used in the oscilloscope. The syntax is:

```
<program mnemonic><terminator>
```

Simple command headers must occur at the beginning of a program message; if not, they must be preceded by a colon.

When program data must be included with the simple command header (for example, :DIGitize CHANnel1), white space is added to separate the data from the header. The syntax is:

```
<program mnemonic><separator><program data><terminator>
```

Compound Command Headers

Compound command headers are a combination of two or more program mnemonics. The first mnemonic selects the subsystem, and the second mnemonic selects the function within that subsystem. The mnemonics within the compound message are separated by colons. For example, to execute a single function within a subsystem:

```
:<subsystem>:<function><separator><program data><terminator>
```

For example, :CHANnel1:BWLimit ON

Common Command Headers

Common command headers control IEEE 488.2 functions within the instrument (such as clear status). Their syntax is:

```
*<command header><terminator>
```

No space or separator is allowed between the asterisk (*) and the command header. *CLS is an example of a common command header.

Program Data Syntax Rules

Program data is used to convey a parameter information related to the command header. At least one space must separate the command header or query header from the program data.

```
<program mnemonic><separator><data><terminator>
```

When a program mnemonic or query has multiple program data, a comma separates sequential program data.

```
<program mnemonic><separator><data>,<data><terminator>
```

For example, :MEASure:DELay CHANnel1,CHANnel2 has two program data: CHANnel1 and CHANnel2.

Two main types of program data are used in commands: character and numeric.

Character Program Data

Character program data is used to convey parameter information as alpha or alphanumeric strings. For example, the :TIMEbase:MODE command can be set to normal, zoomed (delayed), XY, or ROLL. The character program data in this case may be MAIN, WINDOW, XY, or ROLL. The command :TIMEbase:MODE WINDOW sets the time base mode to zoomed.

The available mnemonics for character program data are always included with the command's syntax definition.

When sending commands, you may either the long form or short form (if one exists). Uppercase and lowercase letters may be mixed freely.

When receiving query responses, uppercase letters are used exclusively.

Numeric Program Data

Some command headers require program data to be expressed numerically. For example, :TIMEbase:RANGE requires the desired full scale range to be expressed numerically.

For numeric program data, you have the option of using exponential notation or using suffix multipliers to indicate the numeric value. The following numbers are all equal:

```
28 = 0.28E2 = 280e-1 = 28000m = 0.028K = 28e-3K.
```

When a syntax definition specifies that a number is an integer, that means that the number should be whole. Any fractional part will be ignored, truncating the number. Numeric data parameters accept fractional values are called real numbers.

All numbers must be strings of ASCII characters. Thus, when sending the number 9, you would send a byte representing the ASCII code for the character 9 (which is 57). A three-digit number like 102 would take up three bytes (ASCII codes 49, 48, and 50). This is handled automatically when you include the entire instruction in a string.

Command Tree

The command tree shows all of the commands and the relationships of the commands to each other. The IEEE 488.2 common commands are not listed as part of the command tree because they do not affect the position of the parser within the tree. When a program message terminator (<NL>, linefeed-ASCII decimal 10) or a leading colon (:) is sent to the instrument, the parser is set to the root of the command tree.

- **:(root)**
 - :ACQuire (see [page 173](#))
 - :AALias (see [page 175](#))
 - :COMPLete (see [page 176](#))
 - :COUNT (see [page 177](#))
 - :DAALias (see [page 178](#))
 - :MODE (see [page 179](#))
 - :POINTs (see [page 180](#))
 - :RSIGnal (see [page 181](#))
 - :SEGMENTed
 - :ANALyze (see [page 182](#))
 - :COUNT (see [page 183](#))
 - :INDEX (see [page 184](#))
 - :SRATE (see [page 187](#))
 - :TYPE (see [page 188](#))
 - :ACTivity (see [page 134](#))
 - :AER (Arm Event Register) (see [page 135](#))
 - :AUToscale (see [page 136](#))
 - :AMODE (see [page 138](#))
 - :CHANnels (see [page 139](#))
 - :BLANK (see [page 140](#))
 - :BUS<n> (see [page 190](#))

- :BIT<m> (see [page 192](#))
- :BITS (see [page 193](#))
- :CLEAr (see [page 195](#))
- :DISPlay (see [page 196](#))
- :LABel (see [page 197](#))
- :MASK (see [page 198](#))
- :CALibrate (see [page 199](#))
 - :DATE (see [page 201](#))
 - :LABel (see [page 202](#))
 - :OUTPut (see [page 203](#))
 - :STARt (see [page 204](#))
 - :STATus (see [page 205](#))
 - :SWITch (see [page 206](#))
 - :TEMPerature (see [page 207](#))
 - :TIME (see [page 208](#))
- :CDISplay (see [page 141](#))
- :CHANnel<n> (see [page 209](#))
 - :BWLimit (see [page 212](#))
 - :COUPling (see [page 213](#))
 - :DISPlay (see [page 214](#))
 - :IMPedance (see [page 215](#))
 - :INVert (see [page 216](#))
 - :LABel (see [page 217](#))
 - :OFFSet (see [page 218](#))
 - :PROBe (see [page 219](#))
 - :ID (see [page 220](#))
 - :SKEW (see [page 221](#))
 - :STYPe (see [page 222](#))
 - :PROTection (see [page 223](#))
 - :RANGe (see [page 224](#))
 - :SCALE (see [page 225](#))
 - :UNITs (see [page 226](#))
 - :VERNier (see [page 227](#))
- :DIGital<n> (see [page 228](#))
 - :DISPlay (see [page 230](#))

- :LABel (see [page 231](#))
- :POSition (see [page 232](#))
- :SIZE (see [page 233](#))
- :THReshold (see [page 234](#))
- :DIGitize (see [page 142](#))
- :DISPlay (see [page 235](#))
 - :CLEar (see [page 237](#))
 - :DATA (see [page 238](#))
 - :LABel (see [page 240](#))
 - :LABList (see [page 241](#))
 - :PERsistence (see [page 242](#))
 - :SOURce (see [page 243](#))
 - :VECTors (see [page 244](#))
- :EXTernal (see [page 245](#))
 - :BWLimit (see [page 247](#))
 - :IMPedance (see [page 248](#))
 - :PROBe (see [page 249](#))
 - :ID (see [page 250](#))
 - :STYPe (see [page 251](#))
 - :PROTection (see [page 252](#))
 - :RANGe (see [page 253](#))
 - :UNITs (see [page 254](#))
- :FUNCTion (see [page 255](#))
 - :CENTer (see [page 258](#))
 - :DISPlay (see [page 259](#))
 - :GOFT
 - :OPERation (see [page 260](#))
 - :SOURce1 (see [page 261](#))
 - :SOURce2 (see [page 262](#))
 - :OFFSet (see [page 263](#))
 - :OPERation (see [page 264](#))
 - :RANGe (see [page 265](#))
 - :REFerence (see [page 266](#))
 - :SCALE (see [page 267](#))
 - :SOURce1 (see [page 268](#))

- :SOURce2 (see [page 269](#))
- :SPAN (see [page 270](#))
- :WINDow (see [page 271](#))
- :HARDcopy (see [page 272](#))
 - :AREA (see [page 274](#))
 - :APRinter (see [page 275](#))
 - :FACTors (see [page 276](#))
 - :FFEed (see [page 277](#))
 - :INKSaver (see [page 278](#))
 - :LAYout (see [page 279](#))
 - :PALette (see [page 280](#))
 - [:PRINter]
 - :LIST (see [page 281](#))
 - [:STARt] (see [page 282](#))
- :HWEenable (Hardware Event Enable Register) (see [page 144](#))
- :HWERegister
 - :CONDition (Hardware Event Condition Register) (see [page 146](#))
 - [:EVENT] (Hardware Event Event Register) (see [page 148](#))
- :MARKer (see [page 283](#))
 - :MODE (see [page 285](#))
 - :X1Position (see [page 286](#))
 - :X1Y1source (see [page 287](#))
 - :X2Position (see [page 288](#))
 - :X2Y2source (see [page 289](#))
 - :XDELta (see [page 290](#))
 - :Y1Position (see [page 291](#))
 - :Y2Position (see [page 292](#))
 - :YDELta (see [page 293](#))
- :MEASure (see [page 294](#))
 - :CLEar (see [page 302](#))
 - :COUNter (see [page 303](#))
 - :DEFine (see [page 304](#))
 - :DELay (see [page 307](#))
 - :DUTYcycle (see [page 309](#))
 - :FALLtime (see [page 310](#))

- :FREQuency (see [page 311](#))
- :NWIDth (see [page 312](#))
- :OVERshoot (see [page 313](#))
- :PERiod (see [page 315](#))
- :PHASe (see [page 316](#))
- :PREShoot (see [page 317](#))
- :PWIDth (see [page 318](#))
- :RISetime (see [page 322](#))
- :RESults (see [page 319](#))
- :SDEViation (see [page 323](#))
- :SHOW (see [page 324](#))
- :SOURce (see [page 325](#))
- :STATistics (see [page 327](#))
 - :INCRement (see [page 328](#))
 - :RESet (see [page 329](#))
- :TEDGe (see [page 330](#))
- :TVALue (see [page 332](#))
- :VAMPLitude (see [page 334](#))
- :VAverage (see [page 335](#))
- :VBASE (see [page 336](#))
- :VMAX (see [page 337](#))
- :VMIN (see [page 338](#))
- :VPP (see [page 339](#))
- :VRATio (see [page 340](#))
- :VRMS (see [page 341](#))
- :VTIME (see [page 342](#))
- :VTOP (see [page 343](#))
- :XMAX (see [page 344](#))
- :XMIN (see [page 345](#))
- :MERGe (see [page 150](#))
- :MTEenable (Mask Test Event Enable Register) (see [page 151](#))
- :MTERegister[:EVENT] (Mask Test Event Event Register) (see [page 153](#))
- :MTEST (see [page 346](#))
 - :AMASK
 - :CREate (see [page 351](#))

- :SOURCe (see [page 352](#))
- :UNITs (see [page 353](#))
- :XDELta (see [page 354](#))
- :YDELta (see [page 355](#))
- :COUNT
 - :FWAVeforms (see [page 356](#))
 - :RESet (see [page 357](#))
 - :TIME (see [page 358](#))
 - :WAVeforms (see [page 359](#))
- :DATA (see [page 360](#))
- :DELeTe (see [page 361](#))
- :ENABle (see [page 362](#))
- :LOCK (see [page 363](#))
- :OUTPut (see [page 364](#))
- :RMODE (see [page 365](#))
 - :FACTION
 - :PRINt (see [page 366](#))
 - :SAVE (see [page 367](#))
 - :STOP (see [page 368](#))
 - :SIGMa (see [page 369](#))
 - :TIME (see [page 370](#))
 - :WAVeforms (see [page 371](#))
- :SCALE
 - :BIND (see [page 372](#))
 - :X1 (see [page 373](#))
 - :XDELta (see [page 374](#))
 - :Y1 (see [page 375](#))
 - :Y2 (see [page 376](#))
- :SOURce (see [page 377](#))
- :TITLe (see [page 378](#))
- :OPEE (Operation Status Enable Register) (see [page 155](#))
- :OPERRegister
 - :CONDition (Operation Status Condition Register) (see [page 157](#))
 - [:EVENT] (Operation Status Event Register) (see [page 159](#))
- :OVLenable (Overload Event Enable Register) (see [page 161](#))

- :OVLRegister (Overload Event Register) (see [page 163](#))
- :POD<n> (see [page 379](#))
 - :DISPlay (see [page 380](#))
 - :SIZE (see [page 381](#))
 - :THReshold (see [page 382](#))
- :RECall
 - :FILename (see [page 385](#))
 - :IMAGe (see [page 386](#))
 - [:START] (see [page 386](#))
 - :MASK (see [page 387](#))
 - [:START] (see [page 387](#))
 - :PWD (see [page 388](#))
 - :SETup (see [page 389](#))
 - [:START] (see [page 389](#))
- :RUN (see [page 166](#))
- :SAVE
 - :FILename (see [page 392](#))
 - :IMAGe (see [page 393](#))
 - [:START] (see [page 393](#))
 - :AREA (see [page 394](#))
 - :FACTors (see [page 395](#))
 - :FORMat (see [page 396](#))
 - :IGColors (see [page 397](#))
 - :PALette (see [page 398](#))
 - :MASK (see [page 399](#))
 - [:START] (see [page 399](#))
 - :PWD (see [page 400](#))
 - :SETup (see [page 401](#))
 - [:START] (see [page 401](#))
 - :WAVeform (see [page 402](#))
 - [:START] (see [page 402](#))
 - :FORMat (see [page 403](#))
 - :LENGth (see [page 404](#))
 - :SEGmented (see [page 405](#))
- :SBUS (see [page 406](#))

11 More About Oscilloscope Commands

- :BUSDoctor
 - :ADDRESS (see [page 409](#))
 - :BAUDrate (see [page 410](#))
 - :CHANnel (see [page 411](#))
 - :MODE (see [page 412](#))
- :CAN
 - :COUNT
 - :ERRor (see [page 413](#))
 - :OVERload (see [page 414](#))
 - :RESet (see [page 415](#))
 - :TOTal (see [page 416](#))
 - :UTILization (see [page 417](#))
- :DISPlay (see [page 418](#))
- :FLEXray
 - :COUNT
 - :NULL? (see [page 419](#))
 - :RESet (see [page 420](#))
 - :SYNC? (see [page 421](#))
 - :TOTal? (see [page 422](#))
- :IIC
 - :WIDTh (see [page 426](#))
- :LIN
 - :PARity (see [page 424](#))
- :MODE (see [page 425](#))
- :SPI
 - :ASIZE (see [page 423](#))
- :UART
 - :BASE (see [page 427](#))
 - :COUNT
 - :ERRor (see [page 428](#))
 - :RESet (see [page 429](#))
 - :RXFRames (see [page 430](#))
 - :TXFRames (see [page 431](#))
 - :FRAMing (see [page 432](#))
- :SERial (see [page 167](#))

- :SINGle (see [page 168](#))
- :STATus (see [page 169](#))
- :STOP (see [page 170](#))
- :SYSTem (see [page 433](#))
 - :DATE (see [page 434](#))
 - :DSP (see [page 435](#))
 - :ERRor (see [page 436](#))
 - :LOCK (see [page 437](#))
 - :PROTection
 - :LOCK (see [page 423](#))
 - :SETup (see [page 439](#))
 - :TIME (see [page 441](#))
- :TER (Trigger Event Register) (see [page 171](#))
- :TIMEbase (see [page 442](#))
 - :MODE (see [page 444](#))
 - :POSition (see [page 445](#))
 - :RANGe (see [page 446](#))
 - :REFClock (see [page 447](#))
 - :REFerence (see [page 448](#))
 - :SCALE (see [page 449](#))
 - :VERNier (see [page 450](#))
 - :WINDow
 - :POSition (see [page 451](#))
 - :RANGe (see [page 452](#))
 - :SCALE (see [page 453](#))
- :TRIGger (see [page 454](#))
 - :HFReject (see [page 458](#))
 - :HOLDoff (see [page 459](#))
 - :MODE (see [page 460](#))
 - :NREJect (see [page 461](#))
 - :PATTern (see [page 462](#))
 - :SWEep (see [page 464](#))
 - :CAN (see [page 465](#))
 - :ACKNowledge (see [page 691](#))
 - :PATTern

- :DATA (see [page 467](#))
 - :LENGth (see [page 468](#))
- :ID (see [page 469](#))
 - :MODE (see [page 470](#))
- :SAMPlepoint (see [page 471](#))
- :SIGNal
 - :BAUDrate (see [page 472](#))
 - :DEFinition (see [page 692](#))
- :SOURce (see [page 473](#))
- :TRIGger (see [page 474](#))
- :DURation (see [page 476](#))
 - :GREaterthan (see [page 477](#))
 - :LESSthan (see [page 478](#))
 - :PATTern (see [page 479](#))
 - :QUALifier (see [page 480](#))
 - :RANGe (see [page 481](#))
- :EBURst (see [page 482](#))
 - :COUNT (see [page 483](#))
 - :IDLE (see [page 484](#))
 - :SLOPe (see [page 485](#))
- [:EDGE] (see [page 486](#))
 - :COUPling (see [page 487](#))
 - :LEVel (see [page 488](#))
 - :REJect (see [page 489](#))
 - :SLOPe (see [page 490](#))
 - :SOURce (see [page 491](#))
- :FLEXray (see [page 492](#))
 - :ERRor
 - :TYPE (see [page 493](#))
 - :FRAMe
 - :CCBase (see [page 495](#))
 - :CCRepetition (see [page 496](#))
 - :ID (see [page 497](#))
 - :TYPE (see [page 498](#))
- :TIME

- :CBASe (see [page 499](#))
- :CREPetition (see [page 500](#))
- :SEGMENT (see [page 501](#))
- :SLOT (see [page 502](#))
- :TRIGger (see [page 503](#))
- :GLITCh (see [page 504](#))
 - :GREaterthan (see [page 506](#))
 - :LESSthan (see [page 507](#))
 - :LEVel (see [page 508](#))
 - :POLarity (see [page 509](#))
 - :QUALifier (see [page 510](#))
 - :RANGe (see [page 511](#))
 - :SOURce (see [page 512](#))
- :HFReject (see [page 458](#))
- :HOLDoff (see [page 459](#))
- :IIC (see [page 513](#))
 - :PATtern
 - :ADDRes (see [page 514](#))
 - :DATA (see [page 515](#))
 - :DATa2 (see [page 516](#))
 - :SOURce
 - :CLOCK (see [page 517](#))
 - :DATA (see [page 518](#))
 - :TRIGger
 - :QUALifier (see [page 519](#))
 - [:TYPE] (see [page 520](#))
- :LIN (see [page 522](#))
 - :ID (see [page 523](#))
 - :SAMPlepoint (see [page 524](#))
 - :SIGNal
 - :BAUDrate (see [page 525](#))
 - :DEFinition (see [page 693](#))
 - :SOURce (see [page 526](#))
 - :STANdard (see [page 527](#))
 - :SYNCbreak (see [page 528](#))

- :TRIGger (see [page 529](#))
- :MODE (see [page 460](#))
- :NREJect (see [page 461](#))
- :PATtern (see [page 462](#))
- :SEQuence (see [page 530](#))
 - :COUNT (see [page 531](#))
 - :EDGE (see [page 532](#))
 - :FIND (see [page 533](#))
 - :PATtern (see [page 534](#))
 - :RESet (see [page 535](#))
 - :TIMer (see [page 536](#))
 - :TRIGger (see [page 537](#))
- :SPI (see [page 538](#))
 - :CLOCK
 - :SLOPe (see [page 539](#))
 - :TIMEout (see [page 540](#))
 - :FRAMing (see [page 541](#))
 - :PATtern
 - :DATA (see [page 542](#))
 - :WIDTh (see [page 543](#))
 - :SOURce
 - :CLOCK (see [page 544](#))
 - :DATA (see [page 545](#))
 - :FRAMe (see [page 546](#))
- :SWEep (see [page 464](#))
- :TV (see [page 547](#))
 - :LINE (see [page 548](#))
 - :MODE (see [page 549](#))
 - :POLarity (see [page 550](#))
 - :SOURce (see [page 551](#))
 - :STANdard (see [page 552](#))
 - :TVMode (see [page 695](#))
- :UART (see [page 553](#))
 - :BASE (see [page 555](#))
 - :BAUDrate (see [page 556](#))

- :BITorder (see [page 557](#))
- :BURSt (see [page 558](#))
- :DATA (see [page 559](#))
- :IDLE (see [page 560](#))
- :PARity (see [page 561](#))
- :QUALifier (see [page 563](#))
- :POLarity (see [page 562](#))
- :SOURce
 - :RX (see [page 564](#))
 - :TX (see [page 565](#))
 - :TYPE (see [page 566](#))
 - :WIDTh (see [page 567](#))
- :USB (see [page 568](#))
 - :SOURce
 - :DMINus (see [page 569](#))
 - :DPLus (see [page 570](#))
 - :SPEed (see [page 571](#))
 - :TRIGger (see [page 572](#))
- :VIEW (see [page 172](#))
- :WAVEform (see [page 573](#))
 - :BYTeorder (see [page 581](#))
 - :COUNT (see [page 582](#))
 - :DATA (see [page 583](#))
 - :FORMat (see [page 585](#))
 - :POINTs (see [page 586](#))
 - :MODE (see [page 588](#))
 - :PREamble (see [page 590](#))
 - :SEGmented
 - :COUNT (see [page 593](#))
 - :TTAG (see [page 594](#))
 - :SOURce (see [page 595](#))
 - :SUBSource (see [page 599](#))
 - :TYPE (see [page 600](#))
 - :UNSigned (see [page 601](#))
 - :VIEW (see [page 602](#))

- :XINCrement (see [page 603](#))
 - :XORigin (see [page 604](#))
 - :XREFerence (see [page 605](#))
 - :YINCrement (see [page 606](#))
 - :YORigin (see [page 607](#))
 - :YREFerence (see [page 608](#))
- Common Commands (IEEE 488.2)**
- *CLS (see [page 109](#))
 - *ESE (see [page 110](#))
 - *ESR (see [page 112](#))
 - *IDN (see [page 114](#))
 - *LRN (see [page 115](#))
 - *OPC (see [page 116](#))
 - *OPT (see [page 117](#))
 - *RCL (see [page 119](#))
 - *RST (see [page 120](#))
 - *SAV (see [page 123](#))
 - *SRE (see [page 124](#))
 - *STB (see [page 126](#))
 - *TRG (see [page 128](#))
 - *TST (see [page 129](#))
 - *WAI (see [page 130](#))

Duplicate Mnemonics

Identical function mnemonics can be used in more than one subsystem. For example, the function mnemonic RANGe may be used to change the vertical range or to change the horizontal range:

```
:CHANnel1:RANGe .4
```

Sets the vertical range of channel 1 to 0.4 volts full scale.

```
:TIMEbase:RANGe 1
```

Sets the horizontal time base to 1 second full scale.

:CHANnel1 and :TIMEbase are subsystem selectors and determine which range is being modified.

Tree Traversal Rules and Multiple Commands

Command headers are created by traversing down the Command Tree (see [page 745](#)). A legal command header would be :TIMEbase:RANGe. This is referred to as a *compound header*. A compound header is a header made of two or more mnemonics separated by colons. The mnemonic created contains no spaces.

The following rules apply to traversing the tree:

- A leading colon (<NL> or EOI true on the last byte) places the parser at the root of the command tree. A leading colon is a colon that is the first character of a program header. Executing a subsystem command lets you access that subsystem until a leading colon or a program message terminator (<NL>) or EOI true is found.
- In the command tree, use the last mnemonic in the compound header as the reference point (for example, RANGe). Then find the last colon above that mnemonic (TIMEbase:). That is the point where the parser resides. Any command below that point can be sent within the current program message without sending the mnemonics which appear above them (for example, POSition).

The output statements in the examples are written using the Agilent VISA COM library in Visual Basic. The quoted string is placed on the bus, followed by a carriage return and linefeed (CRLF).

To execute more than one function within the same subsystem, separate the functions with a semicolon (;):

```
:<subsystem>:<function><separator><data>;<function><separator><data><terminator>
```

For example:

```
myScope.WriteString ":TIMEbase:RANGe 0.5;POSition 0"
```

NOTE

The colon between TIMEbase and RANGe is necessary because TIMEbase:RANGe is a compound command. The semicolon between the RANGe command and the POSition command is the required program message unit separator. The POSition command does not need TIMEbase preceding it because the TIMEbase:RANGe command sets the parser to the TIMEbase node in the tree.

Example 2: Program Message Terminator Sets Parser Back to Root

```
myScope.WriteString ":TIMEbase:REference CENTER;POSition 0.00001"
```

OR

```
myScope.WriteString ":TIMEbase:REference CENTER"  
myScope.WriteString ":TIMEbase:POSition 0.00001"
```

NOTE

In the first line of example 2, the subsystem selector is implied for the POSition command in the compound command. The POSition command must be in the same program message as the REFerence command because the program message terminator places the parser back at the root of the command tree.

A second way to send these commands is by placing TIMEbase: before the POSition command as shown in the second part of example 2. The space after POSition is required.

Example 3: Selecting Multiple Subsystems

You can send multiple program commands and program queries for different subsystems on the same line by separating each command with a semicolon. The colon following the semicolon enables you to enter a new subsystem. For example:

```
<program mnemonic><data>;:<program mnemonic><data><terminator>
```

For example:

```
myScope.WriteString ":TIMEbase:REFerence CENTER;:DISPlay:VECTors ON"
```

NOTE

The leading colon before DISPlay:VECTors ON tells the parser to go back to the root of the command tree. The parser can then see the DISPlay:VECTors ON command. The space between REFerence and CENTER is required; so is the space between VECTors and ON.

Multiple commands may be any combination of compound and simple commands.

Query Return Values

Command headers immediately followed by a question mark (?) are queries. Queries are used to get results of measurements made by the instrument or to find out how the instrument is currently configured.

After receiving a query, the instrument interrogates the requested function and places the answer in its output queue. The answer remains in the output queue until it is read or another command is issued.

When read, the answer is transmitted across the bus to the designated listener (typically a controller). For example, the query :TIMEbase:RANGe? places the current time base setting in the output queue. When using the Agilent VISA COM library in Visual Basic, the controller statements:

```
Dim strQueryResult As String
myScope.WriteString ":TIMEbase:RANGe?"
strQueryResult = myScope.ReadString
```

pass the value across the bus to the controller and place it in the variable strQueryResult.

NOTE

Read Query Results Before Sending Another Command. Sending another command or query before reading the result of a query clears the output buffer (the current response) and places a Query INTERRUPTED error in the error queue.

Infinity Representation The representation of infinity is +9.9E+37. This is also the value returned when a measurement cannot be made.

All Oscilloscope Commands Are Sequential

IEEE 488.2 makes the distinction between sequential and overlapped commands:

- *Sequential commands* finish their task before the execution of the next command starts.
- *Overlapped commands* run concurrently. Commands following an overlapped command may be started before the overlapped command is completed.

All of the oscilloscope commands are sequential.

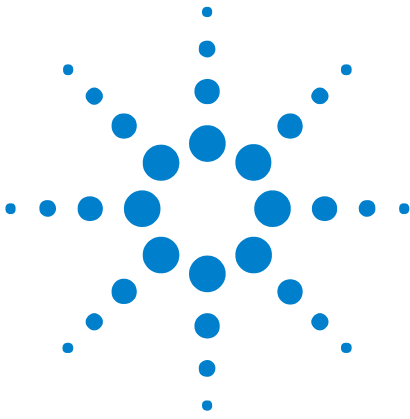

12 Programming Examples

SICL Examples [764](#)

VISA Examples [782](#)

VISA COM Examples [828](#)

Example programs are ASCII text files that can be cut from the help file and pasted into your favorite text editor.



SICL Examples

- "SICL Example in C" on page 764
- "SICL Example in Visual Basic" on page 773

SICL Example in C

To compile and run this example in Microsoft Visual Studio 2005:

- 1 Open Visual Studio.
- 2 Create a new Visual C++, Win32, Win32 Console Application project.
- 3 In the Win32 Application Wizard, click **Next >**. Then, check **Empty project**, and click **Finish**.
- 4 Cut-and-paste the code that follows into a file named "example.c" in the project directory.
- 5 In Visual Studio 2005, right-click the Source Files folder, choose **Add > Add Existing Item...**, select the example.c file, and click **Add**.
- 6 Edit the program to use the SICL address of your oscilloscope.
- 7 Choose **Project > Properties...** In the Property Pages dialog, update these project settings:
 - a Under Configuration Properties, Linker, Input, add "sicl32.lib" to the Additional Dependencies field.
 - b Under Configuration Properties, C/C++, Code Generation, select Multi-threaded DLL for the Runtime Library field.
 - c Click **OK** to close the Property Pages dialog.
- 8 Add the include files and library files search paths:
 - a Choose **Tools > Options...**
 - b In the Options dialog, select **VC++ Directories** under Projects and Solutions.
 - c Show directories for **Include files**, and add the include directory (for example, Program Files\Agilent\ IO Libraries Suite\include).
 - d Show directories for **Library files**, and add the library files directory (for example, Program Files\Agilent\IO Libraries Suite\lib).
 - e Click **OK** to close the Options dialog.
- 9 Build and run the program.

```
/*
 * Agilent SICL Example in C
 * -----
 * This program illustrates most of the commonly-used programming
 * features of your Agilent oscilloscope.
 * This program is to be built as a WIN32 console application.
```

```

* Edit the DEVICE_ADDRESS line to specify the address of the
* applicable device.
*/

#include <stdio.h>           /* For printf(). */
#include "sicl.h"           /* SICL routines. */

/* #define DEVICE_ADDRESS "gpib0,7" */           /* GPIB */
/* #define DEVICE_ADDRESS "lan[a-mso6102-90541]:inst0" */ /* LAN */
#define DEVICE_ADDRESS "usb0[2391::5970::30D3090541::0]" /* USB */

#define WAVE_DATA_SIZE 5000
#define TIMEOUT 5000
#define SETUP_STR_SIZE 3000
#define IMG_SIZE 300000

/* Function prototypes */
void initialize(void);      /* Initialize the oscilloscope. */
void extra(void);          /* Miscellaneous commands not executed,
                           shown for reference purposes. */
void capture(void);        /* Digitize data from oscilloscope. */
void analyze(void);        /* Make some measurements. */
void get_waveform(void);   /* Download waveform data from
                           oscilloscope. */
void save_waveform(void);  /* Save waveform data to a file. */
void retrieve_waveform(void); /* Load waveform data from a file. */

/* Global variables */
INST id;                   /* Device session ID. */
char buf[256] = { 0 };     /* Buffer for IDN string. */

/* Array for waveform data. */
unsigned char waveform_data[WAVE_DATA_SIZE];
double preamble[10];       /* Array for preamble. */

void main(void)
{
    /* Install a default SICL error handler that logs an error message
    * and exits. On Windows 98SE or Windows Me, view messages with
    * the SICL Message Viewer. For Windows 2000 or XP, use the Event
    * Viewer.
    */
    ionerror(I_ERROR_EXIT);

    /* Open a device session using the DEVICE_ADDRESS */
    id = iopen(DEVICE_ADDRESS);

    if (id == 0)
    {
        printf ("Oscilloscope iopen failed!\n");
    }
    else
    {
        printf ("Oscilloscope session initialized!\n");

        /* Set the I/O timeout value for this session to 5 seconds. */
        itimeout(id, TIMEOUT);
    }
}

```

12 Programming Examples

```
        /* Clear the interface. */
        iclear(id);
        iremote(id);
    }

    initialize();

    /* The extras function contains miscellaneous commands that do not
    * need to be executed for the proper operation of this example.
    * The commands in the extras function are shown for reference
    * purposes only.
    */
    /* extra(); */ /* <-- Uncomment to execute the extra function */

    capture();

    analyze();

    /* Close the device session to the instrument. */
    iclose(id);
    printf ("Program execution is complete...\n");

    /* For WIN16 programs, call _siclcleanup before exiting to release
    * resources allocated by SICL for this application. This call is
    * a no-op for WIN32 programs.
    */
    _siclcleanup();
}

/*
 * initialize
 * -----
 * This function initializes both the interface and the oscilloscope
 * to a known state.
 */

void initialize (void)
{
    /* RESET - This command puts the oscilloscope in a known state.
    * Without this command, the oscilloscope settings are unknown.
    * This command is very important for program control.
    *
    * Many of the following initialization commands are initialized
    * by this command. It is not necessary to reinitialize them
    * unless you want to change the default setting.
    */
    fprintf(id, "RST\n");

    /* Write the *IDN? string and send an EOI indicator, then read
    * the response into buf.
    */
    ipromptf(id, "*IDN?\n", "%t", buf);
    printf("%s\n", buf);

    /* AUTOSCALE - This command evaluates all the input signals and
    * sets the correct conditions to display all of the active signals.
    */
}
```

```

    */
    iprintf(id, ":AUTOSCALE\n");

    /* CHANNEL_PROBE - Sets the probe attenuation factor for the
     * selected channel. The probe attenuation factor may be from
     * 0.1 to 1000.
     */
    iprintf(id, ":CHAN1:PROBE 10\n");

    /* CHANNEL_RANGE - Sets the full scale vertical range in volts.
     * The range value is eight times the volts per division.
     */
    iprintf(id, ":CHANNEL1:RANGE 8\n");

    /* TIME_RANGE - Sets the full scale horizontal time in seconds.
     * The range value is ten times the time per division.
     */
    iprintf(id, ":TIM:RANG 2e-3\n");

    /* TIME_REFERENCE - Possible values are LEFT and CENTER:
     * - LEFT sets the display reference one time division from the
     * left.
     * - CENTER sets the display reference to the center of the screen.
     */
    iprintf(id, ":TIMEBASE:REFERENCE CENTER\n");

    /* TRIGGER_SOURCE - Selects the channel that actually produces the
     * TV trigger. Any channel can be selected.
     */
    iprintf(id, ":TRIGGER:TV:SOURCE CHANNEL1\n");

    /* TRIGGER_MODE - Set the trigger mode to, EDGE, GLITCh, PATtern,
     * CAN, DURation, IIC, LIN, SEQuence, SPI, TV, or USB.
     */
    iprintf(id, ":TRIGGER:MODE EDGE\n");

    /* TRIGGER_EDGE_SLOPE - Set the slope of the edge for the trigger
     * to either POSITIVE or NEGATIVE.
     */
    iprintf(id, ":TRIGGER:EDGE:SLOPE POSITIVE\n");
}

/*
 * extra
 * -----
 * The commands in this function are not executed and are shown for
 * reference purposes only. To execute these commands, call this
 * function from main.
 */

void extra (void)
{
    /* RUN_STOP (not executed in this example):
     * - RUN starts the acquisition of data for the active waveform
     * display.
     * - STOP stops the data acquisition and turns off AUTOSTORE.
     */
}

```

12 Programming Examples

```
    iprintf(id, ":RUN\n");
    iprintf(id, ":STOP\n");

    /* VIEW_BLANK (not executed in this example):
     * - VIEW turns on (starts displaying) an active channel or pixel
     *   memory.
     * - BLANK turns off (stops displaying) a specified channel or
     *   pixel memory.
     */
    iprintf(id, ":BLANK CHANNEL1\n");
    iprintf(id, ":VIEW CHANNEL1\n");

    /* TIME_MODE (not executed in this example) - Set the time base
     * mode to MAIN, DELAYED, XY or ROLL.
     */
    iprintf(id, ":TIMEBASE:MODE MAIN\n");
}

/*
 * capture
 * -----
 * This function prepares the scope for data acquisition and then
 * uses the DIGITIZE MACRO to capture some data.
 */

void capture (void)
{
    /* ACQUIRE_TYPE - Sets the acquisition mode. There are three
     * acquisition types NORMAL, PEAK, or AVERAGE.
     */
    iprintf(id, ":ACQUIRE:TYPE NORMAL\n");

    /* ACQUIRE_COMPLETE - Specifies the minimum completion criteria
     * for an acquisition. The parameter determines the percentage
     * of time buckets needed to be "full" before an acquisition is
     * considered to be complete.
     */
    iprintf(id, ":ACQUIRE:COMPLETE 100\n");

    /* DIGITIZE - Used to acquire the waveform data for transfer over
     * the interface. Sending this command causes an acquisition to
     * take place with the resulting data being placed in the buffer.
     */

    /* NOTE! The use of the DIGITIZE command is highly recommended
     * as it will ensure that sufficient data is available for
     * measurement. Keep in mind when the oscilloscope is running,
     * communication with the computer interrupts data acquisition.
     * Setting up the oscilloscope over the bus causes the data
     * buffers to be cleared and internal hardware to be reconfigured.
     * If a measurement is immediately requested there may not have
     * been enough time for the data acquisition process to collect
     * data and the results may not be accurate. An error value of
     * 9.9E+37 may be returned over the bus in this situation.
     */
    iprintf(id, ":DIGITIZE CHAN1\n");
}
```



```

/*
 * analyze
 * -----
 * In this example we will do the following:
 * - Save the system setup to a file for restoration at a later time.
 * - Save the oscilloscope display to a file which can be printed.
 * - Make single channel measurements.
 */

void analyze (void)
{
    double frequency, vpp;          /* Measurements. */
    double vdiv, off, sdiv, delay;  /* Calculated from preamble data. */
    int i;                          /* Loop counter. */
    /* Array for setup string. */
    unsigned char setup_string[SETUP_STR_SIZE];
    int setup_size;
    FILE *fp;
    unsigned char image_data[IMG_SIZE]; /* Array for image data. */
    int img_size;

    /* SAVE_SYSTEM_SETUP - The :SYSTEM:SETUP? query returns a program
     * message that contains the current state of the instrument. Its
     * format is a definite-length binary block, for example,
     * #800002204<setup string><NL>
     * where the setup string is 2204 bytes in length.
     */
    setup_size = SETUP_STR_SIZE;
    /* Query and read setup string. */
    ipromptf(id, ":SYSTEM:SETUP?\n", "%#b\n", &setup_size, setup_string);
    printf("Read setup string query (%d bytes).\n", setup_size);
    /* Write setup string to file. */
    fp = fopen ("c:\\scope\\config\\setup.dat", "wb");
    setup_size = fwrite(setup_string, sizeof(unsigned char), setup_size,
        fp);
    fclose (fp);
    printf("Wrote setup string (%d bytes) to file.\n", setup_size);

    /* RESTORE_SYSTEM_SETUP - Uploads a previously saved setup string
     * to the oscilloscope.
     */
    /* Read setup string from file. */
    fp = fopen ("c:\\scope\\config\\setup.dat", "rb");
    setup_size = fread (setup_string, sizeof(unsigned char),
        SETUP_STR_SIZE, fp);
    fclose (fp);
    printf("Read setup string (%d bytes) from file.\n", setup_size);
    /* Restore setup string. */
    iprintf(id, ":SYSTEM:SETUP #8%08d", setup_size);
    ifwrite(id, setup_string, setup_size, 1, &setup_size);
    printf("Restored setup string (%d bytes).\n", setup_size);

    /* IMAGE_TRANSFER - In this example we will query for the image
     * data with ":DISPLAY:DATA?" to read the data and save the data
     * to the file "image.dat" which you can then send to a printer.
     */
}

```

12 Programming Examples

```
ittimeout(id, 30000);
printf("Transferring image to c:\\scope\\data\\screen.bmp\\n");
img_size = IMG_SIZE;
ipromptf(id, ":DISPLAY:DATA? BMP8bit, SCREEN, COLOR\\n", "%#b\\n",
        &img_size, image_data);
printf("Read display data query (%d bytes).\\n", img_size);
/* Write image data to file. */
fp = fopen ("c:\\scope\\data\\screen.bmp", "wb");
img_size = fwrite(image_data, sizeof(unsigned char), img_size, fp);
fclose (fp);
printf("Wrote image data (%d bytes) to file.\\n", img_size);
ittimeout(id, 5000);

/* MEASURE - The commands in the MEASURE subsystem are used to
 * make measurements on displayed waveforms.
 */

/* Set source to measure. */
iprintf(id, ":MEASURE:SOURCE CHANNEL1\\n");

/* Query for frequency. */
ipromptf(id, ":MEASURE:FREQUENCY?\\n", "%lf", &frequency);
printf("The frequency is: %.4f kHz\\n", frequency / 1000);

/* Query for peak to peak voltage. */
ipromptf(id, ":MEASURE:VPP?\\n", "%lf", &vpp);
printf("The peak to peak voltage is: %.2f V\\n", vpp);

/* WAVEFORM_DATA - Get waveform data from oscilloscope.
 */
get_waveform();

/* Make some calculations from the preamble data. */
vdiv = 32 * preamble [7];
off = preamble [8];
sdiv = preamble [2] * preamble [4] / 10;
delay = (preamble [2] / 2) * preamble [4] + preamble [5];

/* Print them out... */
printf ("Scope Settings for Channel 1:\\n");
printf ("Volts per Division = %f\\n", vdiv);
printf ("Offset = %f\\n", off);
printf ("Seconds per Division = %f\\n", sdiv);
printf ("Delay = %f\\n", delay);

/* print out the waveform voltage at selected points */
for (i = 0; i < 1000; i = i + 50)
    printf ("Data Point %4d = %6.2f Volts at %10f Seconds\\n", i,
        ((float)waveform_data[i] - preamble[9]) * preamble[7] +
        preamble[8],
        ((float)i - preamble[6]) * preamble[4] + preamble[5]);

save_waveform();          /* Save waveform data to disk. */
retrieve_waveform();     /* Load waveform data from disk. */
}

/*
```

```

* get_waveform
* -----
* This function transfers the data displayed on the oscilloscope to
* the computer for storage, plotting, or further analysis.
*/

void get_waveform (void)
{
    int waveform_size;

    /* WAVEFORM_DATA - To obtain waveform data, you must specify the
    * WAVEFORM parameters for the waveform data prior to sending the
    * ":WAVEFORM:DATA?" query.
    *
    * Once these parameters have been sent, the ":WAVEFORM:PREAMBLE?"
    * query provides information concerning the vertical and horizontal
    * scaling of the waveform data.
    *
    * With the preamble information you can then use the
    * ":WAVEFORM:DATA?" query and read the data block in the
    * correct format.
    */

    /* WAVE_FORMAT - Sets the data transmission mode for waveform data
    * output. This command controls how the data is formatted when
    * sent from the oscilloscope and can be set to WORD or BYTE format.
    */

    /* Set waveform format to BYTE. */
    fprintf(id, ":WAVEFORM:FORMAT BYTE\n");

    /* WAVE_POINTS - Sets the number of points to be transferred.
    * The number of time points available is returned by the
    * "ACQUIRE:POINTS?" query. This can be set to any binary
    * fraction of the total time points available.
    */
    fprintf(id, ":WAVEFORM:POINTS 1000\n");

    /* GET_PREAMBLE - The preamble contains all of the current WAVEFORM
    * settings returned in the form <preamble block><NL> where the
    * <preamble block> is:
    *   FORMAT      : int16 - 0 = BYTE, 1 = WORD, 2 = ASCII.
    *   TYPE        : int16 - 0 = NORMAL, 1 = PEAK DETECT, 2 = AVERAGE.
    *   POINTS      : int32 - number of data points transferred.
    *   COUNT       : int32 - 1 and is always 1.
    *   XINCREMENT  : float64 - time difference between data points.
    *   XORIGIN     : float64 - always the first data point in memory.
    *   XREFERENCE  : int32 - specifies the data point associated
    *                       with the x-origin.
    *   YINCREMENT  : float32 - voltage difference between data points.
    *   YORIGIN     : float32 - value of the voltage at center screen.
    *   YREFERENCE  : int32 - data point where y-origin occurs.
    */
    printf("Reading preamble\n");
    ipromptf(id, ":WAVEFORM:PREAMBLE?\n", "%,10lf\n", preamble);
    /*
    printf("Preamble FORMAT: %e\n", preamble[0]);

```

```

printf("Preamble TYPE: %e\n", preamble[1]);
printf("Preamble POINTS: %e\n", preamble[2]);
printf("Preamble COUNT: %e\n", preamble[3]);
printf("Preamble XINCREMENT: %e\n", preamble[4]);
printf("Preamble XORIGIN: %e\n", preamble[5]);
printf("Preamble XREFERENCE: %e\n", preamble[6]);
printf("Preamble YINCREMENT: %e\n", preamble[7]);
printf("Preamble YORIGIN: %e\n", preamble[8]);
printf("Preamble YREFERENCE: %e\n", preamble[9]);
*/

/* QUERY_WAVE_DATA - Outputs waveform records to the controller
 * over the interface that is stored in a buffer previously
 * specified with the ":WAVEFORM:SOURCE" command.
 */
iprintf(id, ":WAVEFORM:DATA?\n"); /* Query waveform data. */

/* READ_WAVE_DATA - The wave data consists of two parts: the header,
 * and the actual waveform data followed by an New Line (NL)
 * character. The query data has the following format:
 *
 * <header><waveform data block><NL>
 *
 * Where:
 *
 * <header> = #800002048 (this is an example header)
 *
 * The "#8" may be stripped off of the header and the remaining
 * numbers are the size, in bytes, of the waveform data block.
 * The size can vary depending on the number of points acquired
 * for the waveform which can be set using the ":WAVEFORM:POINTS"
 * command. You may then read that number of bytes from the
 * oscilloscope; then, read the following NL character to
 * terminate the query.
 */
waveform_size = WAVE_DATA_SIZE;
/* Read waveform data. */
iscanf(id, "%#b\n", &waveform_size, waveform_data);
if ( waveform_size == WAVE_DATA_SIZE )
{
    printf("Waveform data buffer full: ");
    printf("May not have received all points.\n");
}
else
{
    printf("Reading waveform data... size = %d\n", waveform_size);
}
}

/*
 * save_waveform
 * -----
 * This function saves the waveform data from the get_waveform
 * function to disk. The data is saved to a file called "wave.dat".
 */

void save_waveform(void)

```

```

{
    FILE *fp;

    fp = fopen("c:\\scope\\data\\wave.dat", "wb");
    /* Write preamble. */
    fwrite(preamble, sizeof(preamble[0]), 10, fp);
    /* Write actually waveform data. */
    fwrite(waveform_data, sizeof(waveform_data[0]),
           (int)preamble[2], fp);
    fclose (fp);
}

/*
 * retrieve_waveform
 * -----
 * This function retrieves previously saved waveform data from a
 * file called "wave.dat".
 */

void retrieve_waveform(void)
{
    FILE *fp;

    fp = fopen("c:\\scope\\data\\wave.dat", "rb");
    /* Read preamble. */
    fread (preamble, sizeof(preamble[0]), 10, fp);
    /* Read the waveform data. */
    fread (waveform_data, sizeof(waveform_data[0]),
           (int)preamble[2], fp);
    fclose (fp);
}

```

SICL Example in Visual Basic

To run this example in Visual Basic for Applications:

- 1 Start the application that provides Visual Basic for Applications (for example, Microsoft Excel).
- 2 Press ALT+F11 to launch the Visual Basic editor.
- 3 Add the sicl32.bas file to your project:
 - a Choose **File>Import File....**
 - b Navigate to the header file, sicl32.bas (installed with Agilent IO Libraries Suite and found in the Program Files\Agilent\IO Libraries Suite\include directory), select it, and click **Open**.
- 4 Choose **Insert>Module**.
- 5 Cut-and-paste the code that follows into the editor.
- 6 Edit the program to use the SICL address of your oscilloscope, and save the changes.
- 7 Run the program.

12 Programming Examples

```
'
' Agilent SICL Example in Visual Basic
' -----
' This program illustrates a few commonly-used programming
' features of your Agilent oscilloscope.
' -----

Option Explicit

Public id As Integer ' Session to instrument.

' Declare variables to hold numeric values returned by
' ivscanf/ifread.
Public dblQueryResult As Double
Public Const ByteArraySize = 5000000
Public retCount As Long
Public byteArray(ByteArraySize) As Byte

' Declare fixed length string variable to hold string value returned
' by ivscanf.
Public strQueryResult As String * 200

'
' Main Program
' -----

Sub Main()

    On Error GoTo ErrorHandler

    ' Open a device session using the SICL_ADDRESS.
    id = iopen("lan[130.29.69.12]:inst0")
    Call itimeout(id, 5000)

    ' Initialize - start from a known state.
    Initialize

    ' Capture data.
    Capture

    ' Analyze the captured waveform.
    Analyze

    ' Close the vi session and the resource manager session.
    Call iclose(id)

    Exit Sub

ErrorHandler:

    MsgBox "*** Error : " + Error, vbExclamation
    End

End Sub

'
' Initialize the oscilloscope to a known state.
```

```

' -----
Private Sub Initialize()

    On Error GoTo ErrorHandler

    ' Clear the interface.
    Call iclear(id)

    ' Get and display the device's *IDN? string.
    strQueryResult = DoQueryString("*IDN?")
    MsgBox "Result is: " + RTrim(strQueryResult), vbOKOnly, "*IDN? Result"

    ' Clear status and load the default setup.
    DoCommand "*CLS"
    DoCommand "*RST"

    Exit Sub

ErrorHandler:

    MsgBox "*** Error : " + Error, vbExclamation
    End

End Sub

'
' Capture the waveform.
' -----

Private Sub Capture()

    On Error GoTo ErrorHandler

    ' Use auto-scale to automatically configure oscilloscope.
    ' -----
    DoCommand ":AUToscale"

    ' Save oscilloscope configuration.
    ' -----

    Dim lngSetupStringSize As Long
    lngSetupStringSize = DoQueryIEEEBlock_Bytes(":SYSTem:SETup?")
    Debug.Print "Setup bytes saved: " + CStr(lngSetupStringSize)

    ' Output setup string to a file:
    Dim strPath As String
    strPath = "c:\scope\config\setup.dat"

    ' Open file for output.
    Dim hFile As Long
    hFile = FreeFile
    Open strPath For Binary Access Write Lock Write As hFile
    Dim lngI As Long
    For lngI = 0 To lngSetupStringSize - 1
        Put hFile, , byteArray(lngI) ' Write data.
    Next lngI
    Close hFile ' Close file.

```

12 Programming Examples

```
' Or, configure the settings with individual commands:
' -----

' Set trigger mode and input source.
DoCommand ":TRIGger:MODE EDGE"
Debug.Print "Trigger mode: " + _
    DoQueryString(":TRIGger:MODE?")

' Set EDGE trigger parameters.
DoCommand ":TRIGger:EDGE:SOURCe CHANnel1"
Debug.Print "Trigger edge source: " + _
    DoQueryString(":TRIGger:EDGE:SOURce?")

DoCommand ":TRIGger:EDGE:LEVel 1.5"
Debug.Print "Trigger edge level: " + _
    DoQueryString(":TRIGger:EDGE:LEVel?")

DoCommand ":TRIGger:EDGE:SLOPe POSitive"
Debug.Print "Trigger edge slope: " + _
    DoQueryString(":TRIGger:EDGE:SLOPe?")

' Set vertical scale and offset.
DoCommand ":CHANnel1:SCALe 0.5"
Debug.Print "Channel 1 vertical scale: " + _
    DoQueryString(":CHANnel1:SCALe?")

DoCommand ":CHANnel1:OFFSet 1.5"
Debug.Print "Channel 1 vertical offset: " + _
    DoQueryString(":CHANnel1:OFFSet?")

' Set horizontal scale and offset.
DoCommand ":TIMEbase:SCALe 0.0002"
Debug.Print "Timebase scale: " + _
    DoQueryString(":TIMEbase:SCALe?")

DoCommand ":TIMEbase:POSition 0.0"
Debug.Print "Timebase position: " + _
    DoQueryString(":TIMEbase:POSition?")

' Set the acquisition type (NORMAL, PEAK, AVERage, or HRESolution).
DoCommand ":ACQuire:TYPE NORMAL"
Debug.Print "Acquire type: " + _
    DoQueryString(":ACQuire:TYPE?")

' Or, configure by loading a previously saved setup.
' -----
strPath = "c:\scope\config\setup.dat"
Open strPath For Binary Access Read As hFile ' Open file for input.
Dim lngSetupFileSize As Long
lngSetupFileSize = LOF(hFile) ' Length of file.
Get hFile, , byteArray ' Read data.
Close hFile ' Close file.
' Write learn string back to oscilloscope using ":SYSTem:SETup"
' command:
Dim lngRestored As Long
lngRestored = DoCommandIEEEBlock(":SYSTem:SETup", lngSetupFileSize)
```



```

Debug.Print "Setup bytes restored: " + CStr(lngRestored)

' Acquire data.
' -----
DoCommand ":DIGitize"

Exit Sub

ErrorHandler:

MsgBox "*** Error : " + Error, vbExclamation
End

End Sub

'
' Analyze the captured waveform.
' -----

Private Sub Analyze()

On Error GoTo ErrorHandler

' Make a couple of measurements.
' -----
DoCommand ":MEASure:SOURce CHANnel1"
Debug.Print "Measure source: " + _
    DoQueryString(":MEASure:SOURce?")

DoCommand ":MEASure:VAMPlitude"
dblQueryResult = DoQueryNumber(":MEASure:VAMPlitude?")
MsgBox "Vertical amplitude:" + vbCrLf + _
    FormatNumber(dblQueryResult, 4) + " V"

DoCommand ":MEASure:FREQuency"
dblQueryResult = DoQueryNumber(":MEASure:FREQuency?")
MsgBox "Frequency:" + vbCrLf + _
    FormatNumber(dblQueryResult / 1000, 4) + " kHz"

' Download the screen image.
' -----
' Get screen image.
Dim lngBlockSize As Long
lngBlockSize = _
    DoQueryIEEEBlock_Bytes(":DISPlay:DATA? PNG, SCReen, COLOr")
Debug.Print "Image IEEEBlock bytes: " + CStr(lngBlockSize)

' Save screen image to a file:
Dim strPath As String
strPath = "c:\scope\data\screen.png"
Dim hFile As Long
hFile = FreeFile
Open strPath For Binary Access Write Lock Write As hFile
Dim lngI As Long
For lngI = 10 To lngBlockSize - 1 ' Skip past 10-byte header.
    Put hFile, , byteArray(lngI) ' Write data.
Next lngI

```

```

Close hFile ' Close file.
MsgBox "Screen image written to " + strPath

' Download waveform data.
' -----
Dim lngPoints As Long
Dim dblXIncrement As Double
Dim dblXOrigin As Double
Dim dblYIncrement As Double
Dim dblYOrigin As Double
Dim dblYReference As Double

' Set the waveform source.
DoCommand ":WAVEform:SOURce CHANnel1"
Debug.Print "Waveform source: " + _
    DoQueryString(":WAVEform:SOURce?")

' Get the number of waveform points:
' How do you get max depth like when saving CSV from front panel?
dblQueryResult = DoQueryNumber(":WAVEform:POINts?")
lngPoints = dblQueryResult
Debug.Print "Waveform points, channel 1: " + _
    CStr(lngPoints)

' Display the waveform settings:
dblXIncrement = DoQueryNumber(":WAVEform:XINCrement?")
Debug.Print "Waveform X increment, channel 1: " + _
    Format(dblXIncrement, "Scientific")
dblXOrigin = DoQueryNumber(":WAVEform:XORigin?")
Debug.Print "Waveform X origin, channel 1: " + _
    Format(dblXOrigin, "Scientific")

dblYIncrement = DoQueryNumber(":WAVEform:YINCrement?")
Debug.Print "Waveform Y increment, channel 1: " + _
    Format(dblYIncrement, "Scientific")
dblYOrigin = DoQueryNumber(":WAVEform:YORigin?")
Debug.Print "Waveform Y origin, channel 1: " + _
    Format(dblYOrigin, "Scientific")
dblYReference = DoQueryNumber(":WAVEform:YREFerence?")
Debug.Print "Waveform Y reference, channel 1: " + _
    Format(dblYReference, "Scientific")

' Choose the format of the data returned (WORD, BYTE, ASCII):
DoCommand ":WAVEform:FORMat BYTE"
Debug.Print "Waveform format: " + _
    DoQueryString(":WAVEform:FORMat?")
' Data in range 0 to 255.
Dim lngVSteps As Long
Dim intBytesPerData As Integer
lngVSteps = 256
intBytesPerData = 1

' Get the waveform data
Dim lngNumBytes As Long
lngNumBytes = DoQueryIEEEBlock_Bytes(":WAVEform:DATA?")
Debug.Print "Waveform data IEEEBlock bytes: " + CStr(lngNumBytes)

```

```

' Set up output file:
strPath = "c:\scope\data\waveform_data.csv"

' Open file for output.
Open strPath For Output Access Write Lock Write As hFile

' Output waveform data in CSV format.
Dim lngDataValue As Long

For lngI = 10 To lngNumBytes - 2 ' Skip past 10-byte header.
  lngDataValue = CLng(byteArray(lngI))

  ' Write time value, voltage value.
  Print #hFile, _
    Format(dblXOrigin + lngI * dblXIncrement, "Scientific") + _
    ", " + _
    FormatNumber((lngDataValue - dblyReference) * dblyIncrement + _
    dblyOrigin)

Next lngI

' Close output file.
Close hFile ' Close file.
MsgBox "Waveform format BYTE data written to " + _
  "c:\scope\data\waveform_data.csv."

Exit Sub

ErrorHandler:

  MsgBox "*** Error : " + Error, vbExclamation
End

End Sub

Private Sub DoCommand(command As String)

  On Error GoTo ErrorHandler

  Call ivprintf(id, command + vbLf)
  CheckForInstrumentErrors command

  Exit Sub

ErrorHandler:

  MsgBox "*** Error : " + Error, vbExclamation
End

End Sub

Private Function DoCommandIEEEBlock(command As String, _
  lngBlockSize As Long)

  On Error GoTo ErrorHandler

  ' Send command part.

```

12 Programming Examples

```
Call ivprintf(id, command + " ")
' Write definite-length block bytes.
Call ifwrite(id, byteArray(), lngBlockSize, vbNull, retCount)
' retCount is now actual number of bytes written.
CheckForInstrumentErrors command
DoCommandIEEEBlock = retCount

Exit Function

ErrorHandler:

MsgBox "*** Error : " + Error, vbExclamation
End

End Function

Private Function DoQueryString(query As String) As String

Dim actual As Long

On Error GoTo ErrorHandler

Dim ret_val As Integer
Dim strResult As String * 200

Call ivprintf(id, query + vbLf)
Call ivscanf(id, "%200t", strResult)
CheckForInstrumentErrors query
DoQueryString = strResult

Exit Function

ErrorHandler:

MsgBox "*** Error : " + Error, vbExclamation
End

End Function

Private Function DoQueryNumber(query As String) As Double

On Error GoTo ErrorHandler

Dim dblResult As Double

Call ivprintf(id, query + vbLf)
Call ivscanf(id, "%lf" + vbLf, dblResult)
CheckForInstrumentErrors query
DoQueryNumber = dblResult

Exit Function

ErrorHandler:

MsgBox "*** Error : " + Error, vbExclamation
End
```

```

End Function

Private Function DoQueryIEEEBlock_Bytes(query As String) As Long

    On Error GoTo ErrorHandler

    ' Send query.
    Call ivprintf(id, query + vbCrLf)
    ' Read definite-length block bytes.
    Call ifread(id, byteArray(), ByteArraySize, vbNull, retCount)
    ' retCount is now actual number of bytes returned by read.
    CheckForInstrumentErrors query
    DoQueryIEEEBlock_Bytes = retCount

Exit Function

ErrorHandler:

    MsgBox "*** Error : " + Error, vbExclamation
End

End Function

Private Sub CheckForInstrumentErrors(strCmdOrQuery As String)

    On Error GoTo ErrorHandler

    Dim strErrVal As String * 200
    Dim strOut As String

    Do
        Call ivprintf(id, "SYSTEM:ERROR?" + vbCrLf) ' Request error message.
        Call ivscanf(id, "%200t", strErrVal) ' Read: Errno,"Error String".
        If Val(strErrVal) <> 0 Then
            strOut = strOut + "INST Error: " + RTrim(strErrVal) + vbCrLf
        End If
    Loop While Val(strErrVal) <> 0 ' End if find: 0,"No Error".

    If Not strOut = "" Then
        MsgBox strOut, vbExclamation, "INST Error Messages, " + _
            strCmdOrQuery
        Call iflush(id, I_BUF_DISCARD_READ Or I_BUF_DISCARD_WRITE)
    End If

Exit Sub

ErrorHandler:

    MsgBox "*** Error: " + Error, vbExclamation

End Sub

```

VISA Examples

- "VISA Example in C" on page 782
- "VISA Example in Visual Basic" on page 791
- "VISA Example in C#" on page 801
- "VISA Example in Visual Basic .NET" on page 815

VISA Example in C

To compile and run this example in Microsoft Visual Studio 2005:

- 1 Open Visual Studio.
- 2 Create a new Visual C++, Win32, Win32 Console Application project.
- 3 In the Win32 Application Wizard, click **Next** >. Then, check **Empty project**, and click **Finish**.
- 4 Cut-and-paste the code that follows into a file named "example.c" in the project directory.
- 5 In Visual Studio 2005, right-click the Source Files folder, choose **Add** > **Add Existing Item...**, select the example.c file, and click **Add**.
- 6 Edit the program to use the VISA address of your oscilloscope.
- 7 Choose **Project** > **Properties...** In the Property Pages dialog, update these project settings:
 - a Under Configuration Properties, Linker, Input, add "visa32.lib" to the Additional Dependencies field.
 - b Under Configuration Properties, C/C++, Code Generation, select Multi-threaded DLL for the Runtime Library field.
 - c Click **OK** to close the Property Pages dialog.
- 8 Add the include files and library files search paths:
 - a Choose **Tools** > **Options...**
 - b In the Options dialog, select **VC++ Directories** under Projects and Solutions.
 - c Show directories for **Include files**, and add the include directory (for example, Program Files\VISA\winnt\include).
 - d Show directories for **Library files**, and add the library files directory (for example, Program Files\VISA\winnt\lib\msc).
 - e Click **OK** to close the Options dialog.
- 9 Build and run the program.

```
/*  
* Agilent VISA Example in C  
* -----
```

```

* This program illustrates most of the commonly-used programming
* features of your Agilent oscilloscope.
* This program is to be built as a WIN32 console application.
* Edit the RESOURCE line to specify the address of the
* applicable device.
*/

#include <stdio.h>           /* For printf(). */
#include <visa.h>           /* Agilent VISA routines. */

/* GPIB */
/* #define RESOURCE "GPIB0::7::INSTR" */

/* LAN */
/* #define RESOURCE "TCPIP0::a-mso6102-90541::inst0::INSTR" */

/* USB */
#define RESOURCE "USB0::2391::5970::30D3090541::0::INSTR"

#define WAVE_DATA_SIZE 5000
#define TIMEOUT        5000
#define SETUP_STR_SIZE 3000
#define IMG_SIZE       300000

/* Function prototypes */
void initialize(void);      /* Initialize the oscilloscope. */
void extra(void);          /* Miscellaneous commands not executed,
                           shown for reference purposes. */
void capture(void);        /* Digitize data from oscilloscope. */
void analyze(void);        /* Make some measurements. */
void get_waveform(void);   /* Download waveform data from
                           oscilloscope. */
void save_waveform(void);  /* Save waveform data to a file. */
void retrieve_waveform(void); /* Load waveform data from a file. */

/* Global variables */
ViSession defaultRM, vi;   /* Device session ID. */
char buf[256] = { 0 };     /* Buffer for IDN string. */
unsigned char waveform_data[WAVE_DATA_SIZE]; /* Array for waveform
                                                data. */
double preamble[10];       /* Array for preamble. */

void main(void)
{
    /* Open session. */
    viOpenDefaultRM(&defaultRM);
    viOpen(defaultRM, RESOURCE, VI_NULL, VI_NULL, &vi);
    printf ("Oscilloscope session initialized!\n");

    /* Clear the interface. */
    viClear(vi);

    initialize();

    /* The extras function contains miscellaneous commands that do not
     * need to be executed for the proper operation of this example.

```

12 Programming Examples

```
    * The commands in the extras function are shown for reference
    * purposes only.
    */
/* extra(); */ /* <-- Uncomment to execute the extra function */

capture();

analyze();

/* Close session */
viClose(vi);
viClose(defaultRM);
printf ("Program execution is complete...\n");
}

/*
 * initialize
 * -----
 * This function initializes both the interface and the oscilloscope
 * to a known state.
 */

void initialize (void)
{
    /* RESET - This command puts the oscilloscope in a known state.
    * Without this command, the oscilloscope settings are unknown.
    * This command is very important for program control.
    *
    * Many of the following initialization commands are initialized
    * by this command. It is not necessary to reinitialize them
    * unless you want to change the default setting.
    */
    viPrintf(vi, "*RST\n");

    /* Write the *IDN? string and send an EOI indicator, then read
    * the response into buf.
    viQueryf(vi, "*IDN?\n", "%t", buf);
    printf("%s\n", buf);
    */

    /* AUTOSCALE - This command evaluates all the input signals and
    * sets the correct conditions to display all of the active signals.
    */
    viPrintf(vi, ":AUTOSCALE\n");

    /* CHANNEL_PROBE - Sets the probe attenuation factor for the
    * selected channel. The probe attenuation factor may be from
    * 0.1 to 1000.
    */
    viPrintf(vi, ":CHAN1:PROBE 10\n");

    /* CHANNEL_RANGE - Sets the full scale vertical range in volts.
    * The range value is eight times the volts per division.
    */
    viPrintf(vi, ":CHANNEL1:RANGE 8\n");

    /* TIME_RANGE - Sets the full scale horizontal time in seconds.
```



```

    * The range value is ten times the time per division.
    */
viPrintf(vi, ":TIM:RANG 2e-3\n");

/* TIME_REFERENCE - Possible values are LEFT and CENTER:
 * - LEFT sets the display reference one time division from the
 *   left.
 * - CENTER sets the display reference to the center of the screen.
 */
viPrintf(vi, ":TIMEBASE:REFERENCE CENTER\n");

/* TRIGGER_SOURCE - Selects the channel that actually produces the
 * TV trigger. Any channel can be selected.
 */
viPrintf(vi, ":TRIGGER:TV:SOURCE CHANNEL1\n");

/* TRIGGER_MODE - Set the trigger mode to, EDGE, GLITCh, PATtern,
 * CAN, DURation, IIC, LIN, SEQuence, SPI, TV, or USB.
 */
viPrintf(vi, ":TRIGGER:MODE EDGE\n");

/* TRIGGER_EDGE_SLOPE - Set the slope of the edge for the trigger
 * to either POSITIVE or NEGATIVE.
 */
viPrintf(vi, ":TRIGGER:EDGE:SLOPE POSITIVE\n");
}

/*
 * extra
 * -----
 * The commands in this function are not executed and are shown for
 * reference purposes only. To execute these commands, call this
 * function from main.
 */

void extra (void)
{
    /* RUN_STOP (not executed in this example):
     * - RUN starts the acquisition of data for the active waveform
     *   display.
     * - STOP stops the data acquisition and turns off AUTOSTORE.
     */
viPrintf(vi, ":RUN\n");
viPrintf(vi, ":STOP\n");

    /* VIEW_BLANK (not executed in this example):
     * - VIEW turns on (starts displaying) an active channel or pixel
     *   memory.
     * - BLANK turns off (stops displaying) a specified channel or
     *   pixel memory.
     */
viPrintf(vi, ":BLANK CHANNEL1\n");
viPrintf(vi, ":VIEW CHANNEL1\n");

    /* TIME_MODE (not executed in this example) - Set the time base
     * mode to MAIN, DELAYED, XY or ROLL.
     */

```

12 Programming Examples

```
    viPrintf(vi, ":TIMEBASE:MODE MAIN\n");
}

/*
 * capture
 * -----
 * This function prepares the scope for data acquisition and then
 * uses the DIGITIZE MACRO to capture some data.
 */

void capture (void)
{
    /* ACQUIRE_TYPE - Sets the acquisition mode. There are three
     * acquisition types NORMAL, PEAK, or AVERAGE.
     */
    viPrintf(vi, ":ACQUIRE:TYPE NORMAL\n");

    /* ACQUIRE_COMPLETE - Specifies the minimum completion criteria
     * for an acquisition. The parameter determines the percentage
     * of time buckets needed to be "full" before an acquisition is
     * considered to be complete.
     */
    viPrintf(vi, ":ACQUIRE:COMPLETE 100\n");

    /* DIGITIZE - Used to acquire the waveform data for transfer over
     * the interface. Sending this command causes an acquisition to
     * take place with the resulting data being placed in the buffer.
     */

    /* NOTE! The use of the DIGITIZE command is highly recommended
     * as it will ensure that sufficient data is available for
     * measurement. Keep in mind when the oscilloscope is running,
     * communication with the computer interrupts data acquisition.
     * Setting up the oscilloscope over the bus causes the data
     * buffers to be cleared and internal hardware to be reconfigured.
     * If a measurement is immediately requested there may not have
     * been enough time for the data acquisition process to collect
     * data and the results may not be accurate. An error value of
     * 9.9E+37 may be returned over the bus in this situation.
     */
    viPrintf(vi, ":DIGITIZE CHAN1\n");
}

/*
 * analyze
 * -----
 * In this example we will do the following:
 * - Save the system setup to a file for restoration at a later time.
 * - Save the oscilloscope display to a file which can be printed.
 * - Make single channel measurements.
 */

void analyze (void)
{
    double frequency, vpp;          /* Measurements. */
    double vdiv, off, sdiv, delay; /* Values calculated from preamble
                                     data. */
}
```

```

int i;                                /* Loop counter. */
unsigned char setup_string[SETUP_STR_SIZE]; /* Array for setup
                                           string. */

int setup_size;
FILE *fp;
unsigned char image_data[IMG_SIZE];    * Array for image data. */
int img_size;

/* SAVE_SYSTEM_SETUP - The :SYSTEM:SETUP? query returns a program
 * message that contains the current state of the instrument. Its
 * format is a definite-length binary block, for example,
 * #800002204<setup string><NL>
 * where the setup string is 2204 bytes in length.
 */
setup_size = SETUP_STR_SIZE;
/* Query and read setup string. */
viQueryf(vi, ":SYSTEM:SETUP?\n", "%#b\n", &setup_size, setup_string);
printf("Read setup string query (%d bytes).\n", setup_size);
/* Write setup string to file. */
fp = fopen ("c:\\scope\\config\\setup.dat", "wb");
setup_size = fwrite(setup_string, sizeof(unsigned char), setup_size,
                    fp);
fclose (fp);
printf("Wrote setup string (%d bytes) to file.\n", setup_size);

/* RESTORE_SYSTEM_SETUP - Uploads a previously saved setup string
 * to the oscilloscope.
 */
/* Read setup string from file. */
fp = fopen ("c:\\scope\\config\\setup.dat", "rb");
setup_size = fread (setup_string, sizeof(unsigned char),
                    SETUP_STR_SIZE, fp);
fclose (fp);
printf("Read setup string (%d bytes) from file.\n", setup_size);
/* Restore setup string. */
viPrintf(vi, ":SYSTEM:SETUP #8%08d", setup_size);
viBufWrite(vi, setup_string, setup_size, &setup_size);
viPrintf(vi, "\n");
printf("Restored setup string (%d bytes).\n", setup_size);

/* IMAGE_TRANSFER - In this example we will query for the image
 * data with ":DISPLAY:DATA?" to read the data and save the data
 * to the file "image.dat" which you can then send to a printer.
 */
viSetAttribute(vi, VI_ATTR_TMO_VALUE, 30000);
printf("Transferring image to c:\\scope\\data\\screen.bmp\n");
img_size = IMG_SIZE;
viQueryf(vi, ":DISPLAY:DATA? BMP8bit, SCREEN, COLOR\n", "%#b\n",
        &img_size, image_data);
printf("Read display data query (%d bytes).\n", img_size);
/* Write image data to file. */
fp = fopen ("c:\\scope\\data\\screen.bmp", "wb");
img_size = fwrite(image_data, sizeof(unsigned char), img_size, fp);
fclose (fp);
printf("Wrote image data (%d bytes) to file.\n", img_size);
viSetAttribute(vi, VI_ATTR_TMO_VALUE, 5000);

```

12 Programming Examples

```
/* MEASURE - The commands in the MEASURE subsystem are used to
 * make measurements on displayed waveforms.
 */

/* Set source to measure. */
viPrintf(vi, ":MEASURE:SOURCE CHANNEL1\n");

/* Query for frequency. */
viQueryf(vi, ":MEASURE:FREQUENCY?\n", "%lf", &frequency);
printf("The frequency is: %.4f kHz\n", frequency / 1000);

/* Query for peak to peak voltage. */
viQueryf(vi, ":MEASURE:VPP?\n", "%lf", &vpp);
printf("The peak to peak voltage is: %.2f V\n", vpp);

/* WAVEFORM_DATA - Get waveform data from oscilloscope.
 */
get_waveform();

/* Make some calculations from the preamble data. */
vdiv = 32 * preamble [7];
off = preamble [8];
sdiv = preamble [2] * preamble [4] / 10;
delay = (preamble [2] / 2) * preamble [4] + preamble [5];

/* Print them out... */
printf ("Scope Settings for Channel 1:\n");
printf ("Volts per Division = %f\n", vdiv);
printf ("Offset = %f\n", off);
printf ("Seconds per Division = %f\n", sdiv);
printf ("Delay = %f\n", delay);

/* print out the waveform voltage at selected points */
for (i = 0; i < 1000; i = i + 50)
    printf ("Data Point %4d = %6.2f Volts at %10f Seconds\n", i,
        ((float)waveform_data[i] - preamble[9]) * preamble[7] +
        preamble[8],
        ((float)i - preamble[6]) * preamble[4] + preamble[5]);

save_waveform();          /* Save waveform data to disk. */
retrieve_waveform();      /* Load waveform data from disk. */
}

/*
 * get_waveform
 * -----
 * This function transfers the data displayed on the oscilloscope to
 * the computer for storage, plotting, or further analysis.
 */

void get_waveform (void)
{
    int waveform_size;

    /* WAVEFORM_DATA - To obtain waveform data, you must specify the
     * WAVEFORM parameters for the waveform data prior to sending the
     * ":WAVEFORM:DATA?" query.
     */
}
```

```

*
* Once these parameters have been sent, the ":WAVEFORM:PREAMBLE?"
* query provides information concerning the vertical and horizontal
* scaling of the waveform data.
*
* With the preamble information you can then use the
* ":WAVEFORM:DATA?" query and read the data block in the
* correct format.
*/

/* WAVE_FORMAT - Sets the data transmission mode for waveform data
* output. This command controls how the data is formatted when
* sent from the oscilloscope and can be set to WORD or BYTE format.
*/

/* Set waveform format to BYTE. */
viPrintf(vi, ":WAVEFORM:FORMAT BYTE\n");

/* WAVE_POINTS - Sets the number of points to be transferred.
* The number of time points available is returned by the
* "ACQUIRE:POINTS?" query. This can be set to any binary
* fraction of the total time points available.
*/
viPrintf(vi, ":WAVEFORM:POINTS 1000\n");

/* GET_PREAMBLE - The preamble contains all of the current WAVEFORM
* settings returned in the form <preamble block><NL> where the
* <preamble block> is:
*   FORMAT      : int16 - 0 = BYTE, 1 = WORD, 2 = ASCII.
*   TYPE        : int16 - 0 = NORMAL, 1 = PEAK DETECT, 2 = AVERAGE.
*   POINTS      : int32 - number of data points transferred.
*   COUNT       : int32 - 1 and is always 1.
*   XINCREMENT  : float64 - time difference between data points.
*   XORIGIN     : float64 - always the first data point in memory.
*   XREFERENCE  : int32 - specifies the data point associated
*                   with the x-origin.
*   YINCREMENT  : float32 - voltage difference between data points.
*   YORIGIN     : float32 - value of the voltage at center screen.
*   YREFERENCE  : int32 - data point where y-origin occurs.
*/
printf("Reading preamble\n");
viQueryf(vi, ":WAVEFORM:PREAMBLE?\n", "%,10lf\n", preamble);
/*
printf("Preamble FORMAT: %e\n", preamble[0]);
printf("Preamble TYPE: %e\n", preamble[1]);
printf("Preamble POINTS: %e\n", preamble[2]);
printf("Preamble COUNT: %e\n", preamble[3]);
printf("Preamble XINCREMENT: %e\n", preamble[4]);
printf("Preamble XORIGIN: %e\n", preamble[5]);
printf("Preamble XREFERENCE: %e\n", preamble[6]);
printf("Preamble YINCREMENT: %e\n", preamble[7]);
printf("Preamble YORIGIN: %e\n", preamble[8]);
printf("Preamble YREFERENCE: %e\n", preamble[9]);
*/

/* QUERY_WAVE_DATA - Outputs waveform records to the controller
* over the interface that is stored in a buffer previously

```

12 Programming Examples

```
    * specified with the ":WAVEFORM:SOURCE" command.
    */
viPrintf(vi, ":WAVEFORM:DATA?\n"); /* Query waveform data. */

/* READ_WAVE_DATA - The wave data consists of two parts: the header,
 * and the actual waveform data followed by an New Line (NL)
 * character. The query data has the following format:
 *
 * <header><waveform data block><NL>
 *
 * Where:
 *
 * <header> = #800002048 (this is an example header)
 *
 * The "#8" may be stripped off of the header and the remaining
 * numbers are the size, in bytes, of the waveform data block.
 * The size can vary depending on the number of points acquired
 * for the waveform which can be set using the ":WAVEFORM:POINTS"
 * command. You may then read that number of bytes from the
 * oscilloscope; then, read the following NL character to
 * terminate the query.
 */
waveform_size = WAVE_DATA_SIZE;
/* Read waveform data. */
viScanf(vi, "%#b\n", &waveform_size, waveform_data);
if ( waveform_size == WAVE_DATA_SIZE )
{
    printf("Waveform data buffer full: ");
    printf("May not have received all points.\n");
}
else
{
    printf("Reading waveform data... size = %d\n", waveform_size);
}
}

/*
 * save_waveform
 * -----
 * This function saves the waveform data from the get_waveform
 * function to disk. The data is saved to a file called "wave.dat".
 */

void save_waveform(void)
{
    FILE *fp;

    fp = fopen("c:\\scope\\data\\wave.dat", "wb");
    /* Write preamble. */
    fwrite(preamble, sizeof(preamble[0]), 10, fp);
    /* Write actually waveform data. */
    fwrite(waveform_data, sizeof(waveform_data[0]), (int)preamble[2],
           fp);
    fclose(fp);
}

/*
```

```

* retrieve_waveform
* -----
* This function retrieves previously saved waveform data from a
* file called "wave.dat".
*/

void retrieve_waveform(void)
{
    FILE *fp;

    fp = fopen("c:\\scope\\data\\wave.dat", "rb");
    /* Read preamble. */
    fread(preamble, sizeof(preamble[0]), 10, fp);
    /* Read the waveform data. */
    fread(waveform_data, sizeof(waveform_data[0]), (int)preamble[2],
        fp);
    fclose(fp);
}

```

VISA Example in Visual Basic

To run this example in Visual Basic for Applications:

- 1 Start the application that provides Visual Basic for Applications (for example, Microsoft Excel).
- 2 Press ALT+F11 to launch the Visual Basic editor.
- 3 Add the visa32.bas file to your project:
 - a Choose **File>Import File...**
 - b Navigate to the header file, visa32.bas (installed with Agilent IO Libraries Suite and found in the Program Files\VISA\winnt\include directory), select it, and click **Open**.
- 4 Choose **Insert>Module**.
- 5 Cut-and-paste the code that follows into the editor.
- 6 Edit the program to use the VISA address of your oscilloscope, and save the changes.
- 7 Run the program.

```

'
' Agilent VISA Example in Visual Basic
' -----
' This program illustrates most of the commonly-used programming
' features of your Agilent oscilloscope.
' -----

Option Explicit

Public err As Long ' Error returned by VISA function calls.
Public drm As Long ' Session to Default Resource Manager.
Public vi As Long ' Session to instrument.

```

12 Programming Examples

```
' Declare variables to hold numeric values returned by
' viVScanf/viVQueryf.
Public dblQueryResult As Double
Public Const DblArraySize = 20
Public Const ByteArraySize = 5000000
Public retCount As Long
Public dblArray(DblArraySize) As Double
Public byteArray(ByteArraySize) As Byte
Public paramsArray(2) As Long

' Declare fixed length string variable to hold string value returned
' by viVScanf/viVQueryf.
Public strQueryResult As String * 200

'
' MAIN PROGRAM
' -----
' This example shows the fundamental parts of a program (initialize,
' capture, analyze).
'
' The commands sent to the oscilloscope are written in both long and
' short form. Both forms are acceptable.
'
' The input signal is the probe compensation signal from the front
' panel of the oscilloscope connected to channel 1.
'
' If you are using a different signal or different channels, these
' commands may not work as explained in the comments.
' -----

Sub Main()

' Open the default resource manager session.
err = viOpenDefaultRM(drm)

' Open the session to the resource.
' The "GPIB0" parameter is the VISA Interface name to
' an GPIB instrument as defined in:
' Start->Programs->Agilent IO Libraries->IO Config
' Change this name to whatever you have defined for your
' VISA Interface.
' "GPIB0::7::INSTR" is the address string for the device -
' this address will be the same as seen in:
' Start->Programs->Agilent IO Libraries->VISA Assistant
' (after the VISA Interface Name is defined in IO Config).

' err = viOpen(drm, "GPIB0::7::INSTR", 0, 0, vi)
' err = viOpen(drm, "TCPIP0::a-mso6102-90541::inst0::INSTR", 0, 0, vi)
err = viOpen(drm, _
    "USB0::2391::5970::30D3090541::0::INSTR", 0, 60000, vi)

' Initialize - Initialization will start the program with the
' oscilloscope in a known state.
Initialize

' Capture - After initialization, you must make waveform data
' available to analyze. To do this, capture the data using the
```



```

' DIGITIZE command.
Capture

' Analyze - Once the waveform has been captured, it can be analyzed.
' There are many parts of a waveform to analyze. This example shows
' some of the possible ways to analyze various parts of a waveform.
Analyze

' Close the vi session and the resource manager session.
err = viClose(vi)
err = viClose(drm)

End Sub

'
' Initialize
' -----
' Initialize will start the program with the oscilloscope in a known
' state. This is required because some uninitialized conditions could
' cause the program to fail or not perform as expected.
'
' In this example, we initialize the following:
' - Oscilloscope
' - Channel 1 range
' - Display Grid
' - Timebase reference, range, and delay
' - Trigger mode and type
'
' There are also some additional initialization commands, which are
' not used, but shown for reference.
' -----

Private Sub Initialize()

' Clear the interface.
err = viClear(vi)

' RESET - This command puts the oscilloscope into a known state.
' This statement is very important for programs to work as expected.
' Most of the following initialization commands are initialized by
' *RST. It is not necessary to reinitialize them unless the default
' setting is not suitable for your application.

' Reset the oscilloscope to the defaults.
err = viVPrintf(vi, "*RST" + vbLf, 0)

' IDN - Ask for the device's *IDN string.
err = viVPrintf(vi, "*IDN?" + vbLf, 0)
err = viVScanf(vi, "%t", strQueryResult) ' Read the results as a
' string.

' Display results.
MsgBox "Result is: " + strQueryResult, vbOKOnly, "*IDN? Result"

' AUTOSCALE - This command evaluates all the input signals and sets
' the correct conditions to display all of the active signals.
err = viVPrintf(vi, ":AUTOSCALE" + vbLf, 0) ' Same as pressing
' the Autoscale key.

```

12 Programming Examples

```
' CHANNEL_PROBE - Sets the probe attenuation factor for the selected
' channel. The probe attenuation factor may be set from 0.1 to 1000.

' Set Probe to 10:1.
err = viVPrintf(vi, ":CHAN1:PROBE 10" + vbLf, 0)

' CHANNEL_RANGE - Sets the full scale vertical range in volts. The
' range value is 8 times the volts per division.

' Set the vertical range to 8 volts.
err = viVPrintf(vi, ":CHANNEL1:RANGE 8" + vbLf, 0)

' TIME_RANGE - Sets the full scale horizontal time in seconds. The
' range value is 10 times the time per division.

' Set the time range to 0.002 seconds.
err = viVPrintf(vi, ":TIM:RANG 2e-3" + vbLf, 0)

' TIME_REFERENCE - Possible values are LEFT and CENTER.
' - LEFT sets the display reference on time division from the left.
' - CENTER sets the display reference to the center of the screen.

' Set reference to center.
err = viVPrintf(vi, ":TIMEBASE:REFERENCE CENTER" + vbLf, 0)

' TRIGGER_TV_SOURCE - Selects the channel that actually produces the
' TV trigger. Any channel can be selected.
err = viVPrintf(vi, ":TRIGGER:TV:SOURCE CHANNEL1" + vbLf, 0)

' TRIGGER_MODE - Set the trigger mode to EDGE, GLITCh, PATtern, CAN,
' DURATION, IIC, LIN, SEquence, SPI, TV, or USB.

' Set the trigger mode to EDGE.
err = viVPrintf(vi, ":TRIGGER:MODE EDGE" + vbLf, 0)

' TRIGGER_EDGE_SLOPE - Sets the slope of the edge for the trigger.

' Set the slope to positive.
err = viVPrintf(vi, ":TRIGGER:EDGE:SLOPE POSITIVE" + vbLf, 0)

' The following commands are not executed and are shown for reference
' purposes only. To execute these commands, uncomment them.

' RUN_STOP - (not executed in this example)
' - RUN starts the acquisition of data for the active waveform
' display.
' - STOP stops the data acquisition and turns off AUTOSTORE.

' Start data acquisition.
err = viVPrintf(vi, ":RUN" + vbLf, 0)

' Stop the data acquisition.
err = viVPrintf(vi, ":STOP" + vbLf, 0)

' VIEW_BLANK - (not executed in this example)
' - VIEW turns on (starts displaying) a channel or pixel memory.
```

```

' - BLANK turns off (stops displaying) a channel or pixel memory.

' Turn channel 1 off.
' err = viVPrintf(vi, ":BLANK CHANNEL1" + vbLf, 0)

' Turn channel 1 on.
' err = viVPrintf(vi, ":VIEW CHANNEL1" + vbLf, 0)

' TIMEBASE_MODE - (not executed in this example)
' Set the time base mode to MAIN, DELAYED, XY, or ROLL.

' Set time base mode to main.
' err = viVPrintf(vi, ":TIMEBASE:MODE MAIN" + vbLf, 0)

End Sub

'
' Capture
' -----
' We will capture the waveform using the digitize command.
' -----

Private Sub Capture()

' ACQUIRE_TYPE - Sets the acquisition mode, which can be NORMAL,
' PEAK, or AVERAGE.
err = viVPrintf(vi, ":ACQUIRE:TYPE NORMAL" + vbLf, 0)

' ACQUIRE_COMPLETE - Specifies the minimum completion criteria for
' an acquisition. The parameter determines the percentage of time
' buckets needed to be "full" before an acquisition is considered
' to be complete.
err = viVPrintf(vi, ":ACQUIRE:COMPLETE 100" + vbLf, 0)

' DIGITIZE - Used to acquire the waveform data for transfer over
' the interface. Sending this command causes an acquisition to
' take place with the resulting data being placed in the buffer.
'
' NOTE! The DIGITIZE command is highly recommended for triggering
' modes other than SINGLE. This ensures that sufficient data is
' available for measurement. If DIGITIZE is used with single mode,
' the completion criteria may never be met. The number of points
' gathered in Single mode is related to the sweep speed, memory
' depth, and maximum sample rate. For example, take an oscilloscope
' with a 1000-point memory, a sweep speed of 10 us/div (100 us
' total time across the screen), and a 20 MSa/s maximum sample rate.
' 1000 divided by 100 us equals 10 MSa/s. Because this number is
' less than or equal to the maximum sample rate, the full 1000 points
' will be digitized in a single acquisition. Now, use 1 us/div
' (10 us across the screen). 1000 divided by 10 us equals 100 MSa/s;
' because this is greater than the maximum sample rate by 5 times,
' only 400 points (or 1/5 the points) can be gathered on a single
' trigger. Keep in mind when the oscilloscope is running,
' communication with the computer interrupts data acquisition.
' Setting up the oscilloscope over the bus causes the data buffers
' to be cleared and internal hardware to be reconfigured. If a
' measurement is immediately requested, there may have not been

```

12 Programming Examples

```
' enough time for the data acquisition process to collect data,
' and the results may not be accurate. An error value of 9.9E+37
' may be returned over the bus in this situation.
'
err = viVPrintf(vi, ":DIGITIZE CHAN1" + vbLf, 0)

End Sub

'
' Analyze
' -----
' In analyze, we will do the following:
' - Save the system setup to a file and restore it.
' - Save the waveform data to a file on the computer.
' - Make single channel measurements.
' - Save the oscilloscope display to a file that can be sent to a
'   printer.
' -----

Private Sub Analyze()

' Set up arrays for multiple parameter query returning an array
' with viVScanf/viVQueryf. Set retCount to the maximum number
' of elements that the array can hold.
paramsArray(0) = VarPtr(retCount)
paramsArray(1) = VarPtr(byteArray(0))

' SAVE_SYSTEM_SETUP - The :SYSTEM:SETUP? query returns a program
' message that contains the current state of the instrument. Its
' format is a definite-length binary block, for example,
'   #800002204<setup string><NL>
' where the setup string is 2204 bytes in length.
Dim lngSetupStringSize As Long
err = viVPrintf(vi, ":SYSTEM:SETUP?" + vbLf, 0)
retCount = ByteArraySize

' Unsigned integer bytes.
err = viVScanf(vi, "%#b\n" + vbLf, paramsArray(0))
lngSetupStringSize = retCount

' Output setup string to a file:
Dim strPath As String
Dim lngI As Long
strPath = "c:\scope\config\setup.dat"
Close #1 ' If #1 is open, close it.

' Open file for output.
Open strPath For Binary Access Write Lock Write As #1
For lngI = 0 To lngSetupStringSize - 1
    Put #1, , byteArray(lngI) ' Write data.
Next lngI
Close #1 ' Close file.

' IMAGE_TRANSFER - In this example, we will query for the image data
' with ":DISPLAY:DATA?", read the data, and then save it to a file.
err = viVPrintf(vi, ":DISPLAY:DATA? BMP, SCREEN, COLOR" + vbLf, 0)
retCount = ByteArraySize
```

```

' Unsigned integer bytes.
err = viVScanf(vi, "%#b\n" + vbLf, paramsArray(0))
' Output display data to a file:
strPath = "c:\scope\data\screen.bmp"
' Remove file if it exists.
If Len(Dir(strPath)) Then
    Kill strPath
End If
Close #1 ' If #1 is open, close it.

' Open file for output.
Open strPath For Binary Access Write Lock Write As #1
For lngI = 0 To retCount - 1
    Put #1, , byteArray(lngI) ' Write data.
Next lngI
Close #1 ' Close file.

' RESTORE_SYSTEM_SETUP - Read the setup string from a file and write
' it back to the oscilloscope.
strPath = "c:\scope\config\setup.dat"
Open strPath For Binary Access Read As #1 ' Open file for input.
Get #1, , byteArray ' Read data.
Close #1 ' Close file.
' Write learn string back to oscilloscope using ":SYSTEM:SETUP"
' command:
retCount = lngSetupStringSize
err = viVPrintf(vi, ":SYSTEM:SETUP %#b" + vbLf, paramsArray(0))

' MEASURE - The commands in the MEASURE subsystem are used to make
' measurements on displayed waveforms.

' Source to measure
err = viVPrintf(vi, ":MEASURE:SOURCE CHANNEL1" + vbLf, 0)

' Query for frequency.
err = viVPrintf(vi, ":MEASURE:FREQUENCY?" + vbLf, 0)
' Read frequency.
err = viVScanf(vi, "%lf" + vbLf, VarPtr(dblQueryResult))
MsgBox "Frequency:" + vbCrLf + _
    FormatNumber(dblQueryResult / 1000, 4) + " kHz"

' Query for duty cycle.
err = viVPrintf(vi, ":MEASURE:DUTYCYCLE?" + vbLf, 0)
' Read duty cycle.
err = viVScanf(vi, "%lf" + vbLf, VarPtr(dblQueryResult))
MsgBox "Duty cycle:" + vbCrLf + FormatNumber(dblQueryResult, 3) + "%"

' Query for risetime.
err = viVPrintf(vi, ":MEASURE:RISETIME?" + vbLf, 0)
' Read risetime.
err = viVScanf(vi, "%lf" + vbLf, VarPtr(dblQueryResult))
MsgBox "Risetime:" + vbCrLf + _
    FormatNumber(dblQueryResult * 1000000, 4) + " us"

' Query for Peak to Peak voltage.
err = viVPrintf(vi, ":MEASURE:VPP?" + vbLf, 0)

```

12 Programming Examples

```
' Read VPP.
err = viVScanf(vi, "%lf" + vbLf, VarPtr(dblQueryResult))
MsgBox "Peak to peak voltage:" + vbCrLf + _
    FormatNumber(dblQueryResult, 4) + " V"

' Query for Vmax.
err = viVPrintf(vi, ":MEASURE:VMAX?" + vbLf, 0)
' Read Vmax.
err = viVScanf(vi, "%lf" + vbLf, VarPtr(dblQueryResult))
MsgBox "Maximum voltage:" + vbCrLf + _
    FormatNumber(dblQueryResult, 4) + " V"

' WAVEFORM_DATA - To obtain waveform data, you must specify the
' WAVEFORM parameters for the waveform data prior to sending the
' ":WAVEFORM:DATA?" query. Once these parameters have been sent,
' the waveform data and the preamble can be read.
'
' WAVE_SOURCE - Selects the channel to be used as the source for
' the waveform commands.
err = viVPrintf(vi, ":WAVEFORM:SOURCE CHAN1" + vbLf, 0)

' WAVE_POINTS - Specifies the number of points to be transferred
' using the ":WAVEFORM:DATA?" query.
err = viVPrintf(vi, ":WAVEFORM:POINTS 1000" + vbLf, 0)

' WAVE_FORMAT - Sets the data transmission mode for the waveform
' data output. This command controls whether data is formatted in
' a word or byte format when sent from the oscilloscope.
Dim lngVSteps As Long
Dim intBytesPerData As Integer

' Data in range 0 to 65535.
err = viVPrintf(vi, ":WAVEFORM:FORMAT WORD" + vbLf, 0)
lngVSteps = 65536
intBytesPerData = 2

' Data in range 0 to 255.
err = viVPrintf(vi, ":WAVEFORM:FORMAT BYTE" + vbLf, 0)
lngVSteps = 256
intBytesPerData = 1

' GET_PREAMBLE - The preamble block contains all of the current
' WAVEFORM settings. It is returned in the form <preamble_block><NL>
' where <preamble_block> is:
'   FORMAT      : int16 - 0 = BYTE, 1 = WORD, 2 = ASCII.
'   TYPE        : int16 - 0 = NORMAL, 1 = PEAK DETECT, 2 = AVERAGE.
'   POINTS     : int32 - number of data points transferred.
'   COUNT      : int32 - 1 and is always 1.
'   XINCREMENT : float64 - time difference between data points.
'   XORIGIN    : float64 - always the first data point in memory.
'   XREFERENCE : int32 - specifies the data point associated with
'                   x-origin.
'   YINCREMENT : float32 - voltage difference between data points.
'   YORIGIN    : float32 - value is the voltage at center screen.
'   YREFERENCE : int32 - specifies the data point where y-origin
'                   occurs.
Dim intFormat As Integer
```

```

Dim intType As Integer
Dim lngPoints As Long
Dim lngCount As Long
Dim dblXIncrement As Double
Dim dblXOrigin As Double
Dim lngXReference As Long
Dim sngYIncrement As Single
Dim sngYOrigin As Single
Dim lngYReference As Long
Dim strOutput As String

' Query for the preamble.
err = viVPrintf(vi, ":WAVEFORM:PREAMBLE?" + vbLf, 0)
paramsArray(1) = VarPtr(dblArray(0))
retCount = DblArraySize

' Read preamble information.
err = viVScanf(vi, "%,#lf" + vbLf, paramsArray(0))
intFormat = dblArray(0)
intType = dblArray(1)
lngPoints = dblArray(2)
lngCount = dblArray(3)
dblXIncrement = dblArray(4)
dblXOrigin = dblArray(5)
lngXReference = dblArray(6)
sngYIncrement = dblArray(7)
sngYOrigin = dblArray(8)
lngYReference = dblArray(9)
strOutput = ""
'strOutput = strOutput + "Format = " + CStr(intFormat) + vbCrLf
'strOutput = strOutput + "Type = " + CStr(intType) + vbCrLf
'strOutput = strOutput + "Points = " + CStr(lngPoints) + vbCrLf
'strOutput = strOutput + "Count = " + CStr(lngCount) + vbCrLf
'strOutput = strOutput + "X increment = " + _
'     FormatNumber(dblXIncrement * 1000000) + _
'     " us" + vbCrLf
'strOutput = strOutput + "X origin = " + _
'     FormatNumber(dblXOrigin * 1000000) + _
'     " us" + vbCrLf
'strOutput = strOutput + "X reference = " + _
'     CStr(lngXReference) + vbCrLf
'strOutput = strOutput + "Y increment = " + _
'     FormatNumber(sngYIncrement * 1000) + _
'     " mV" + vbCrLf
'strOutput = strOutput + "Y origin = " + _
'     FormatNumber(sngYOrigin) + " V" + vbCrLf
'strOutput = strOutput + "Y reference = " + _
'     CStr(lngYReference) + vbCrLf
strOutput = strOutput + "Volts/Div = " + _
'     FormatNumber(lngVSteps * sngYIncrement / 8) + _
'     " V" + vbCrLf
strOutput = strOutput + "Offset = " + _
'     FormatNumber(sngYOrigin) + " V" + vbCrLf
strOutput = strOutput + "Sec/Div = " + _
'     FormatNumber(lngPoints * dblXIncrement / 10 * _
'     1000000) + " us" + vbCrLf
strOutput = strOutput + "Delay = " + _

```

12 Programming Examples

```
        FormatNumber(((lngPoints / 2) * _
                    dblXIncrement + dblXOrigin) * 1000000) + " us" + vbCrLf

' QUERY_WAVE_DATA - Outputs waveform data that is stored in a buffer.

' Query the oscilloscope for the waveform data.
err = viVPrintf(vi, ":WAV:DATA?" + vbLf, 0)

' READ_WAVE_DATA - The wave data consists of two parts: the header,
' and the actual waveform data followed by a new line (NL) character.
' The query data has the following format:
'
'     <header><waveform_data><NL>
'
' Where:
'
'     <header> = #800001000 (This is an example header)
'
' The "#8" may be stripped off of the header and the remaining
' numbers are the size, in bytes, of the waveform data block. The
' size can vary depending on the number of points acquired for the
' waveform. You can then read that number of bytes from the
' oscilloscope and the terminating NL character.
'
'Dim lngI As Long
Dim lngDataValue As Long

paramsArray(1) = VarPtr(byteArray(0))
retCount = ByteArraySize
' Unsigned integer bytes.
err = viVScanf(vi, "%#b" + vbLf, paramsArray(0))
' retCount is now actual number of bytes returned by query.
For lngI = 0 To retCount - 1 Step (retCount / 2) ' 20 points.
    If intBytesPerData = 2 Then
        lngDataValue = CLng(byteArray(lngI)) * 256 + _
            CLng(byteArray(lngI + 1)) ' 16-bit value.
    Else
        lngDataValue = CLng(byteArray(lngI)) ' 8-bit value.
    End If
    strOutput = strOutput + "Data point " + _
        CStr(lngI / intBytesPerData) + ", " + _
        FormatNumber((lngDataValue - lngYReference) * sngYIncrement + _
            sngYOrigin) + " V, " + _
        FormatNumber(((lngI / intBytesPerData - lngXReference) * _
            dblXIncrement + dblXOrigin) * 1000000) + " us" + vbCrLf
Next lngI
MsgBox "Waveform data:" + vbCrLf + strOutput

' Make a delay measurement between channel 1 and 2.
Dim dblChan1Edge1 As Double
Dim dblChan2Edge1 As Double
Dim dblChan1Edge2 As Double
Dim dblDelay As Double
Dim dblPeriod As Double
Dim dblPhase As Double

' Query time at 1st rising edge on ch1.
```



```

err = viVPrintf(vi, ":MEASURE:TEDGE? +1, CHAN1" + vbLf, 0)

' Read time at edge 1 on ch 1.
err = viVScanf(vi, "%lf", VarPtr(dblChan1Edge1))

' Query time at 1st rising edge on ch2.
err = viVPrintf(vi, ":MEASURE:TEDGE? +1, CHAN2" + vbLf, 0)

' Read time at edge 1 on ch 2.
err = viVScanf(vi, "%lf", VarPtr(dblChan2Edge1))

' Calculate delay time between ch1 and ch2.
dblDelay = dblChan2Edge1 - dblChan1Edge1

' Write calculated delay time to screen.
MsgBox "Delay = " + vbCrLf + CStr(dblDelay)

' Make a phase difference measurement between channel 1 and 2.

' Query time at 1st rising edge on ch1.
err = viVPrintf(vi, ":MEASURE:TEDGE? +2, CHAN1" + vbLf, 0)

' Read time at edge 2 on ch 1.
err = viVScanf(vi, "%lf", VarPtr(dblChan1Edge2))

' Calculate period of ch 1.
dblPeriod = dblChan1Edge2 - dblChan1Edge1

' Calculate phase difference between ch1 and ch2.
dblPhase = (dblDelay / dblPeriod) * 360
MsgBox "Phase = " + vbCrLf + CStr(dblPhase)

End Sub

```

VISA Example in C#

To compile and run this example in Microsoft Visual Studio 2005:

- 1 Open Visual Studio.
- 2 Create a new Visual C#, Windows, Console Application project.
- 3 Cut-and-paste the code that follows into the C# source file.
- 4 Edit the program to use the VISA address of your oscilloscope.

- 5 Add Agilent's VISA header file to your project:
 - a Right-click the project you wish to modify (not the solution) in the Solution Explorer window of the Microsoft Visual Studio environment.
 - b Click **Add** and then click **Add Existing Item...**
 - c Navigate to the header file, visa32.cs (installed with Agilent IO Libraries Suite and found in the Program Files\VISA\winnt\include directory), select it, but *do not click the Open button*.
 - d Click the down arrow to the right of the **Add** button, and choose **Add as Link**.

You should now see the file underneath your project in the Solution Explorer. It will have a little arrow icon in its lower left corner, indicating that it is a link.

- 6 Build and run the program.

For more information, see the tutorial on using VISA in Microsoft .NET in the VISA Help that comes with Agilent IO Libraries Suite 15.

```

/*
 * Agilent VISA Example in C#
 * -----
 * This program illustrates most of the commonly used programming
 * features of your Agilent oscilloscopes.
 * -----
 */

using System;
using System.IO;
using System.Text;

namespace InfiniiVision
{
    class VisaInstrumentApp
    {
        private static VisaInstrument oscp;

        public static void Main(string[] args)
        {
            try
            {
                oscp = new
                    VisaInstrument("USB0::2391::5957::MY47250010::0::INSTR");

                Initialize();

                /* The extras function contains miscellaneous commands that
                 * do not need to be executed for the proper operation of
                 * this example. The commands in the extras function are
                 * shown for reference purposes only.
                 */
                // Extra(); // Uncomment to execute the extra function.
            }
        }
    }
}

```

```

        Capture();
        Analyze();
    }
    catch (System.ApplicationException err)
    {
        Console.WriteLine("*** VISA Error Message : " + err.Message);
    }
    catch (System.SystemException err)
    {
        Console.WriteLine("*** System Error Message : " + err.Message);
    }
    catch (System.Exception err)
    {
        System.Diagnostics.Debug.Fail("Unexpected Error");
        Console.WriteLine("*** Unexpected Error : " + err.Message);
    }
    finally
    {
        oscp.Close();
    }
}

/*
 * Initialize()
 * -----
 * This function initializes both the interface and the
 * oscilloscope to a known state.
 */
private static void Initialize()
{
    StringBuilder strResults;

    /* RESET - This command puts the oscilloscope into a known
     * state. This statement is very important for programs to
     * work as expected. Most of the following initialization
     * commands are initialized by *RST. It is not necessary to
     * reinitialize them unless the default setting is not suitable
     * for your application.
     */
    oscp.DoCommand("*RST"); // Reset the to the defaults.
    oscp.DoCommand("*CLS"); // Clear the status data structures.

    /* IDN - Ask for the device's *IDN string.
     */
    strResults = oscp.DoQueryString("*IDN?");

    // Display results.
    Console.WriteLine("Result is: {0}", strResults);

    /* AUTOSCALE - This command evaluates all the input signals
     * and sets the correct conditions to display all of the
     * active signals.
     */
    oscp.DoCommand(":AUToscale");

    /* CHANNEL_PROBE - Sets the probe attenuation factor for the
     * selected channel. The probe attenuation factor may be from

```

12 Programming Examples

```
    * 0.1 to 1000.
    */
    oscp.DoCommand(":CHANnel1:PROBe 10");

    /* CHANNEL_RANGE - Sets the full scale vertical range in volts.
    * The range value is eight times the volts per division.
    */
    oscp.DoCommand(":CHANnel1:RANGe 8");

    /* TIME_RANGE - Sets the full scale horizontal time in seconds.
    * The range value is ten times the time per division.
    */
    oscp.DoCommand(":TIMEbase:RANGe 2e-3");

    /* TIME_REFERENCE - Possible values are LEFT and CENTER:
    * - LEFT sets the display reference one time division from
    *   the left.
    * - CENTER sets the display reference to the center of the
    *   screen.
    */
    oscp.DoCommand(":TIMEbase:REFerence CENTER");

    /* TRIGGER_SOURCE - Selects the channel that actually produces
    * the TV trigger. Any channel can be selected.
    */
    oscp.DoCommand(":TRIGger:TV:SOURCe CHANnel1");

    /* TRIGGER_MODE - Set the trigger mode to, EDGE, GLITCh,
    * PATTern, CAN, DURation, IIC, LIN, SEQUence, SPI, TV,
    * UART, or USB.
    */
    oscp.DoCommand(":TRIGger:MODE EDGE");

    /* TRIGGER_EDGE_SLOPE - Set the slope of the edge for the
    * trigger to either POSITIVE or NEGATIVE.
    */
    oscp.DoCommand(":TRIGger:EDGE:SLOPe POSitive");
}

/*
 * Extra()
 * -----
 * The commands in this function are not executed and are shown
 * for reference purposes only. To execute these commands, call
 * this function from main.
 */
private static void Extra()
{
    /* RUN_STOP (not executed in this example):
    * - RUN starts the acquisition of data for the active
    *   waveform display.
    * - STOP stops the data acquisition and turns off AUTOSTORE.
    */
    oscp.DoCommand(":RUN");
    oscp.DoCommand(":STOP");

    /* VIEW_BLANK (not executed in this example):
```

```

* - VIEW turns on (starts displaying) an active channel or
*   pixel memory.
* - BLANK turns off (stops displaying) a specified channel or
*   pixel memory.
*/
oscp.DoCommand(":BLANK CHANnel1");
oscp.DoCommand(":VIEW CHANnel1");

/* TIME_MODE (not executed in this example) - Set the time base
* mode to MAIN, DELAYED, XY or ROLL.
*/
oscp.DoCommand(":TIMEbase:MODE MAIN");
}

/*
* Capture()
* -----
* This function prepares the scope for data acquisition and then
* uses the DIGITIZE MACRO to capture some data.
*/
private static void Capture()
{
/* ACQUIRE_TYPE - Sets the acquisition mode. There are three
* acquisition types NORMAL, PEAK, or AVERAGE.
*/
oscp.DoCommand(":ACquire:TYPE NORMal");

/* ACQUIRE_COMPLETE - Specifies the minimum completion criteria
* for an acquisition. The parameter determines the percentage
* of time buckets needed to be "full" before an acquisition is
* considered to be complete.
*/
oscp.DoCommand(":ACquire:COMPLETE 100");

/* DIGITIZE - Used to acquire the waveform data for transfer
* over the interface. Sending this command causes an
* acquisition to take place with the resulting data being
* placed in the buffer.
*/

/* NOTE! The use of the DIGITIZE command is highly recommended
* as it will ensure that sufficient data is available for
* measurement. Keep in mind when the oscilloscope is running,
* communication with the computer interrupts data acquisition.
* Setting up the oscilloscope over the bus causes the data
* buffers to be cleared and internal hardware to be
* reconfigured.
* If a measurement is immediately requested there may not have
* been enough time for the data acquisition process to collect
* data and the results may not be accurate. An error value of
* 9.9E+37 may be returned over the bus in this situation.
*/
oscp.DoCommand(":DIGitize CHANnel1");
}

/*
* Analyze()

```

```

* -----
* In this example we will do the following:
* - Save the system setup to a file for restoration at a later
*   time.
* - Save the oscilloscope display to a file which can be
*   printed.
* - Make single channel measurements.
*/
private static void Analyze()
{
    byte[] ResultsArray;    // Results array.
    int nLength;           // Number of bytes returned from instrument.

    /* SAVE_SYSTEM_SETUP - The :SYSTEM:SETup? query returns a
     * program message that contains the current state of the
     * instrument. Its format is a definite-length binary block,
     * for example,
     *   #800002204<setup string><NL>
     * where the setup string is 2204 bytes in length.
     */
    Console.WriteLine("Saving oscilloscope setup to " +
        "c:\\scope\\config\\setup.dat");
    if (File.Exists("c:\\scope\\config\\setup.dat"))
        File.Delete("c:\\scope\\config\\setup.dat");

    // Query and read setup string.
    nLength = oscp.DoQueryIEEEBlock(":SYSTEM:SETup?",
        out ResultsArray);
    Console.WriteLine("Read oscilloscope setup ({0} bytes).",
        nLength);

    // Write setup string to file.
    File.WriteAllBytes("c:\\scope\\config\\setup.dat",
        ResultsArray);
    Console.WriteLine("Wrote setup string ({0} bytes) to file.",
        nLength);

    /* RESTORE_SYSTEM_SETUP - Uploads a previously saved setup
     * string to the oscilloscope.
     */
    byte[] DataArray;
    int nBytesWritten;

    // Read setup string from file.
    DataArray = File.ReadAllBytes("c:\\scope\\config\\setup.dat");
    Console.WriteLine("Read setup string ({0} bytes) from file.",
        DataArray.Length);

    // Restore setup string.
    nBytesWritten = oscp.DoCommandIEEEBlock(":SYSTEM:SETup",
        DataArray);
    Console.WriteLine("Restored setup string ({0} bytes).",
        nBytesWritten);

    /* IMAGE_TRANSFER - In this example, we query for the screen
     * data with the ":DISPLAY:DATA?" query. The .png format
     * data is saved to a file in the local file system.

```

```

*/
Console.WriteLine("Transferring screen image to " +
    "c:\\scope\\data\\screen.png");
if (File.Exists("c:\\scope\\data\\screen.png"))
    File.Delete("c:\\scope\\data\\screen.png");

// Increase I/O timeout to fifteen seconds.
oscp.SetTimeoutSeconds(15);

// Get the screen data in PNG format.
nLength = oscp.DoQueryIEEEBlock(
    ":DISPlay:DATA? PNG, SCReen, COlor", out ResultsArray);
Console.WriteLine("Read screen image ({0} bytes).", nLength);

// Store the screen data in a file.
File.WriteAllBytes("c:\\scope\\data\\screen.png",
    ResultsArray);
Console.WriteLine("Wrote screen image ({0} bytes) to file.",
    nLength);

// Return I/O timeout to five seconds.
oscp.SetTimeoutSeconds(5);

/* MEASURE - The commands in the MEASURE subsystem are used to
 * make measurements on displayed waveforms.
 */

// Set source to measure.
oscp.DoCommand(":MEASure:SOURce CHANnel1");

// Query for frequency.
double fResults;
fResults = oscp.DoQueryValue(":MEASure:FREQuency?");
Console.WriteLine("The frequency is: {0:F4} kHz",
    fResults / 1000);

// Query for peak to peak voltage.
fResults = oscp.DoQueryValue(":MEASure:VPP?");
Console.WriteLine("The peak to peak voltage is: {0:F2} V",
    fResults);

/* WAVEFORM_DATA - Get waveform data from oscilloscope. To
 * obtain waveform data, you must specify the WAVEFORM
 * parameters for the waveform data prior to sending the
 * ":WAVEFORM:DATA?" query.
 *
 * Once these parameters have been sent, the
 * ":WAVEFORM:PREAMBLE?" query provides information concerning
 * the vertical and horizontal scaling of the waveform data.
 *
 * With the preamble information you can then use the
 * ":WAVEFORM:DATA?" query and read the data block in the
 * correct format.
 */

/* WAVE_FORMAT - Sets the data transmission mode for waveform
 * data output. This command controls how the data is

```

```

* formatted when sent from the oscilloscope and can be set
* to WORD or BYTE format.
*/

// Set waveform format to BYTE.
oscp.DoCommand(":WAVEform:FORMat BYTE");

/* WAVE_POINTS - Sets the number of points to be transferred.
* The number of time points available is returned by the
* "ACQUIRE:POINTS?" query. This can be set to any binary
* fraction of the total time points available.
*/
oscp.DoCommand(":WAVEform:POINTs 1000");

/* GET_PREAMBLE - The preamble contains all of the current
* WAVEFORM settings returned in the form <preamble block><NL>
* where the <preamble block> is:
*   FORMAT      : int16 - 0 = BYTE, 1 = WORD, 2 = ASCII.
*   TYPE        : int16 - 0 = NORMAL, 1 = PEAK DETECT,
*                2 = AVERAGE.
*   POINTS      : int32 - number of data points transferred.
*   COUNT       : int32 - 1 and is always 1.
*   XINCREMENT  : float64 - time difference between data
*                points.
*   XORIGIN     : float64 - always the first data point in
*                memory.
*   XREFERENCE  : int32 - specifies the data point associated
*                with the x-origin.
*   YINCREMENT  : float32 - voltage difference between data
*                points.
*   YORIGIN     : float32 - value of the voltage at center
*                screen.
*   YREFERENCE  : int32 - data point where y-origin occurs.
*/
Console.WriteLine("Reading preamble.");
double[] fResultsArray;
fResultsArray = oscp.DoQueryValues(":WAVEform:PREAmble?");

double fFormat = fResultsArray[0];
Console.WriteLine("Preamble FORMat: {0:e}", fFormat);

double fType = fResultsArray[1];
Console.WriteLine("Preamble TYPE: {0:e}", fType);

double fPoints = fResultsArray[2];
Console.WriteLine("Preamble POINTs: {0:e}", fPoints);

double fCount = fResultsArray[3];
Console.WriteLine("Preamble COUNT: {0:e}", fCount);

double fXincrement = fResultsArray[4];
Console.WriteLine("Preamble XINCrement: {0:e}", fXincrement);

double fXorigin = fResultsArray[5];
Console.WriteLine("Preamble XORigin: {0:e}", fXorigin);

double fXreference = fResultsArray[6];

```



```

Console.WriteLine("Preamble XREference: {0:e}", fXreference);

double fYincrement = fResultsArray[7];
Console.WriteLine("Preamble YINCrement: {0:e}", fYincrement);

double fYorigin = fResultsArray[8];
Console.WriteLine("Preamble YORigin: {0:e}", fYorigin);

double fYreference = fResultsArray[9];
Console.WriteLine("Preamble YREFerence: {0:e}", fYreference);

/* QUERY_WAVE_DATA - Outputs waveform records to the controller
 * over the interface that is stored in a buffer previously
 * specified with the ":WAVEform:SOURce" command.
 */

/* READ_WAVE_DATA - The wave data consists of two parts: the
 * header, and the actual waveform data followed by a
 * New Line (NL) character. The query data has the following
 * format:
 *
 * <header><waveform data block><NL>
 *
 * Where:
 *
 * <header> = #800002048 (this is an example header)
 *
 * The "#8" may be stripped off of the header and the remaining
 * numbers are the size, in bytes, of the waveform data block.
 * The size can vary depending on the number of points acquired
 * for the waveform which can be set using the
 * ":WAVEFORM:POINTS" command. You may then read that number
 * of bytes from the oscilloscope; then, read the following NL
 * character to terminate the query.
 */

// Read waveform data.
nLength = oscp.DoQueryIEEEBlock(":WAVEform:DATA?",
    out ResultsArray);
Console.WriteLine("Read waveform data ({0} bytes).", nLength);

// Make some calculations from the preamble data.
double fVdiv = 32 * fYincrement;
double fOffset = fYorigin;
double fSdiv = fPoints * fXincrement / 10;
double fDelay = (fPoints / 2) * fXincrement + fXorigin;

// Print them out...
Console.WriteLine("Scope Settings for Channel 1:");
Console.WriteLine("Volts per Division = {0:f}", fVdiv);
Console.WriteLine("Offset = {0:f}", fOffset);
Console.WriteLine("Seconds per Division = {0:e}", fSdiv);
Console.WriteLine("Delay = {0:e}", fDelay);

// Print the waveform voltage at selected points:
for (int i = 0; i < 1000; i = i + 50)
    Console.WriteLine("Data point {0:d} = {1:f2} Volts at "

```

12 Programming Examples

```
        + "{2:f10} Seconds", i,
        ((float)ResultsArray[i] - fYreference) * fYincrement +
        fYorigin,
        ((float)i - fXreference) * fXincrement + fXorigin);

/* SAVE_WAVE_DATA - saves the waveform data to a CSV format
 * file named "waveform.csv".
 */
if (File.Exists("c:\\scope\\data\\waveform.csv"))
    File.Delete("c:\\scope\\data\\waveform.csv");

StreamWriter writer =
    File.CreateText("c:\\scope\\data\\waveform.csv");
for (int i = 0; i < 1000; i++)
    writer.WriteLine("{0:E}, {1:f6}",
        ((float)i - fXreference) * fXincrement + fXorigin,
        ((float)ResultsArray[i] - fYreference) * fYincrement +
        fYorigin);
writer.Close();
}
}

class VisaInstrument
{
    private int m_nResourceManager;
    private int m_nSession;
    private string m_strVisaAddress;

    // Constructor.
    public VisaInstrument(string strVisaAddress)
    {
        // Save VISA address in member variable.
        m_strVisaAddress = strVisaAddress;

        // Open the default VISA resource manager.
        OpenResourceManager();

        // Open a VISA resource session.
        OpenSession();

        // Clear the interface.
        int nViStatus;
        nViStatus = visa32.viClear(m_nSession);
    }

    public void DoCommand(string strCommand)
    {
        // Send the command.
        VisaSendCommandOrQuery(strCommand);

        // Check for instrument errors (another command and result).
        CheckForInstrumentErrors(strCommand);
    }

    public int DoCommandIEEEBlock(string strCommand,
        byte[] dataArray)
    {

```

```

// Send the command to the device.
string strCommandAndLength;
int nViStatus, nLength, nBytesWritten;

nLength = dataArray.Length;
strCommandAndLength = String.Format("{0} #8{1:D8}",
    strCommand, nLength);

// Write first part of command to formatted I/O write buffer.
nViStatus = visa32.viPrintf(m_nSession, strCommandAndLength);
CheckVisaStatus(nViStatus);

// Write the data to the formatted I/O write buffer.
nViStatus = visa32.viBufWrite(m_nSession, dataArray, nLength,
    out nBytesWritten);
CheckVisaStatus(nViStatus);

// Write command termination character.
nViStatus = visa32.viPrintf(m_nSession, "\n");
CheckVisaStatus(nViStatus);

// Check for instrument errors (another command and result).
CheckForInstrumentErrors(strCommand);

return nBytesWritten;
}

public StringBuilder DoQueryString(string strQuery)
{
    // Send the query.
    VisaSendCommandOrQuery(strQuery);

    // Get the result string.
    StringBuilder strResults = new StringBuilder(1000);
    strResults = VisaGetResultString();

    // Check for instrument errors (another command and result).
    CheckForInstrumentErrors(strQuery);

    // Return string results.
    return strResults;
}

public double DoQueryValue(string strQuery)
{
    // Send the query.
    VisaSendCommandOrQuery(strQuery);

    // Get the result string.
    double fResults;
    fResults = VisaGetResultValue();

    // Check for instrument errors (another command and result).
    CheckForInstrumentErrors(strQuery);

    // Return string results.
    return fResults;
}

```

```

}

public double[] DoQueryValues(string strQuery)
{
    // Send the query.
    VisaSendCommandOrQuery(strQuery);

    // Get the result string.
    double[] fResultsArray;
    fResultsArray = VisaGetResultValues();

    // Check for instrument errors (another command and result).
    CheckForInstrumentErrors(strQuery);

    // Return string results.
    return fResultsArray;
}

public int DoQueryIEEEBlock(string strQuery,
    out byte[] ResultsArray)
{
    // Send the query.
    VisaSendCommandOrQuery(strQuery);

    // Get the result string.
    int length; // Number of bytes returned from instrument.
    length = VisaGetResultIEEEBlock(out ResultsArray);

    // Check for instrument errors (another command and result).
    CheckForInstrumentErrors(strQuery);

    // Return string results.
    return length;
}

private void CheckForInstrumentErrors(string strCommand)
{
    // Check for instrument errors.
    StringBuilder strInstrumentError = new StringBuilder(1000);
    bool bFirstError = true;
    do
    {
        VisaSendCommandOrQuery(":SYSTem:ERRor?");
        strInstrumentError = VisaGetResultString();

        if (strInstrumentError.ToString() != "+0, \"No error\\\"\\n\")
        {
            if (bFirstError)
            {
                Console.WriteLine("ERROR(s) for command '{0}': ",
                    strCommand);
                bFirstError = false;
            }
            Console.Write(strInstrumentError);
        }
    } while (strInstrumentError.ToString() != "+0, \"No error\\\"\\n\");
}

```

```

private void VisaSendCommandOrQuery(string strCommandOrQuery)
{
    // Send command or query to the device.
    string strWithNewline;
    strWithNewline = String.Format("{0}\n", strCommandOrQuery);
    int nViStatus;
    nViStatus = visa32.viPrintf(m_nSession, strWithNewline);
    CheckVisaStatus(nViStatus);
}

private StringBuilder VisaGetResultString()
{
    StringBuilder strResults = new StringBuilder(1000);

    // Read return value string from the device.
    int nViStatus;
    nViStatus = visa32.viScanf(m_nSession, "%1000t", strResults);
    CheckVisaStatus(nViStatus);

    return strResults;
}

private double VisaGetResultValue()
{
    double fResults = 0;

    // Read return value string from the device.
    int nViStatus;
    nViStatus = visa32.viScanf(m_nSession, "%lf", out fResults);
    CheckVisaStatus(nViStatus);

    return fResults;
}

private double[] VisaGetResultValues()
{
    double[] fResultsArray;
    fResultsArray = new double[10];

    // Read return value string from the device.
    int nViStatus;
    nViStatus = visa32.viScanf(m_nSession, "%,10lf\n",
        fResultsArray);
    CheckVisaStatus(nViStatus);

    return fResultsArray;
}

private int VisaGetResultIEEEBlock(out byte[] ResultsArray)
{
    // Results array, big enough to hold a PNG.
    ResultsArray = new byte[300000];
    int length; // Number of bytes returned from instrument.

    // Set the default number of bytes that will be contained in
    // the ResultsArray to 300,000 (300kB).

```

12 Programming Examples

```
length = 300000;

// Read return value string from the device.
int nViStatus;
nViStatus = visa32.viScanf(m_nSession, "%#b", ref length,
    ResultsArray);
CheckVisaStatus(nViStatus);

// Write and read buffers need to be flushed after IEEE block?
nViStatus = visa32.viFlush(m_nSession, visa32.VI_WRITE_BUF);
CheckVisaStatus(nViStatus);
nViStatus = visa32.viFlush(m_nSession, visa32.VI_READ_BUF);
CheckVisaStatus(nViStatus);

return length;
}

private void OpenResourceManager()
{
    int nViStatus;
    nViStatus =
        visa32.viOpenDefaultRM(out this.m_nResourceManager);
    if (nViStatus < visa32.VI_SUCCESS)
        throw new
            ApplicationException("Failed to open Resource Manager");
}

private void OpenSession()
{
    int nViStatus;
    nViStatus = visa32.viOpen(this.m_nResourceManager,
        this.m_strVisaAddress, visa32.VI_NO_LOCK,
        visa32.VI_TMO_IMMEDIATE, out this.m_nSession);
    CheckVisaStatus(nViStatus);
}

public void SetTimeoutSeconds(int nSeconds)
{
    int nViStatus;
    nViStatus = visa32.viSetAttribute(this.m_nSession,
        visa32.VI_ATTR_TMO_VALUE, nSeconds * 1000);
    CheckVisaStatus(nViStatus);
}

public void CheckVisaStatus(int nViStatus)
{
    // If VISA error, throw exception.
    if (nViStatus < visa32.VI_SUCCESS)
    {
        StringBuilder strError = new StringBuilder(256);
        visa32.viStatusDesc(this.m_nResourceManager, nViStatus,
            strError);
        throw new ApplicationException(strError.ToString());
    }
}

public void Close()
```

```

    {
        if (m_nSession != 0)
            visa32.viClose(m_nSession);
        if (m_nResourceManager != 0)
            visa32.viClose(m_nResourceManager);
    }
}
}

```

VISA Example in Visual Basic .NET

To compile and run this example in Microsoft Visual Studio 2005:

- 1 Open Visual Studio.
- 2 Create a new Visual Basic, Windows, Console Application project.
- 3 Cut-and-paste the code that follows into the Visual Basic .NET source file.
- 4 Edit the program to use the VISA address of your oscilloscope.
- 5 Add Agilent's VISA header file to your project:
 - a Right-click the project you wish to modify (not the solution) in the Solution Explorer window of the Microsoft Visual Studio environment.
 - b Choose **Add** and then choose **Add Existing Item...**
 - c Navigate to the header file, visa32.vb (installed with Agilent IO Libraries Suite and found in the Program Files\VISA\winnt\include directory), select it, but *do not click the Open button*.
 - d Click the down arrow to the right of the **Add** button, and choose **Add as Link**.

You should now see the file underneath your project in the Solution Explorer. It will have a little arrow icon in its lower left corner, indicating that it is a link.

- e Right-click the project again and choose **Properties**; then, select "InfiniiVision.VisaInstrumentApp" as the **Startup object**.
- 6 Build and run the program.

For more information, see the tutorial on using VISA in Microsoft .NET in the VISA Help that comes with Agilent IO Libraries Suite 15.

```

'
' Agilent VISA Example in Visual Basic .NET
' -----
' This program illustrates most of the commonly-used programming
' features of your Agilent oscilloscope.
' -----

Imports System
Imports System.IO

```

12 Programming Examples

```
Imports System.Text

Namespace InfiniiVision
Class VisaInstrumentApp
Private Shared oscp As VisaInstrument

Public Shared Sub Main(ByVal args As String())
Try
oscp = _
New VisaInstrument("USB0::2391::5957::MY47250010::0::INSTR")

Initialize()

' The extras function contains miscellaneous commands that
' do not need to be executed for the proper operation of
' this example. The commands in the extras function are
' shown for reference purposes only.

' Extra() ' Uncomment to execute the extra function.
Capture()
Analyze()
Catch err As System.ApplicationException
MsgBox("*** Error : " & err.Message, vbExclamation, _
"VISA Error Message")
Exit Sub
Catch err As System.SystemException
MsgBox("*** Error : " & err.Message, vbExclamation, _
"System Error Message")
Exit Sub
Catch err As System.Exception
Debug.Fail("Unexpected Error")
MsgBox("*** Error : " & err.Message, vbExclamation, _
"Unexpected Error")
Exit Sub
Finally
oscp.Close()
End Try
End Sub

' Initialize()
' -----
' This function initializes both the interface and the
' oscilloscope to a known state.

Private Shared Sub Initialize()
Dim strResults As StringBuilder

' RESET - This command puts the oscilloscope into a known
' state. This statement is very important for programs to
' work as expected. Most of the following initialization
' commands are initialized by *RST. It is not necessary to
' reinitialize them unless the default setting is not suitable
' for your application.

' Reset the to the defaults.
oscp.DoCommand("*RST")
' Clear the status data structures.
```



```

oscp.DoCommand("*CLS")

' IDN - Ask for the device's *IDN string.
strResults = oscp.DoQueryString("*IDN?")
' Display results.
Console.WriteLine("Result is: {0}", strResults)

' AUTOSCALE - This command evaluates all the input signals
' and sets the correct conditions to display all of the
' active signals.
oscp.DoCommand(":AUToscale")

' CHANNEL_PROBE - Sets the probe attenuation factor for the
' selected channel. The probe attenuation factor may be from
' 0.1 to 1000.
oscp.DoCommand(":CHANnel1:PROBe 10")

' CHANNEL_RANGE - Sets the full scale vertical range in volts.
' The range value is eight times the volts per division.
oscp.DoCommand(":CHANnel1:RANGe 8")

' TIME_RANGE - Sets the full scale horizontal time in seconds.
' The range value is ten times the time per division.
oscp.DoCommand(":TIMEbase:RANGe 2e-3")

' TIME_REFERENCE - Possible values are LEFT and CENTER:
' - LEFT sets the display reference one time division from
' the left.
' - CENTER sets the display reference to the center of the
' screen.
oscp.DoCommand(":TIMEbase:REFerence CENTER")

' TRIGGER_SOURCE - Selects the channel that actually produces
' the TV trigger. Any channel can be selected.
oscp.DoCommand(":TRIGger:TV:SOURCe CHANnel1")

' TRIGGER_MODE - Set the trigger mode to, EDGE, GLITCh,
' PATtern, CAN, DURation, IIC, LIN, SEQuence, SPI, TV,
' UART, or USB.
oscp.DoCommand(":TRIGger:MODE EDGE")

' TRIGGER_EDGE_SLOPE - Set the slope of the edge for the
' trigger to either POSITIVE or NEGATIVE.
oscp.DoCommand(":TRIGger:EDGE:SLOPe POSitive")

End Sub

' Extra()
' -----
' The commands in this function are not executed and are shown
' for reference purposes only. To execute these commands, call
' this function from main.

Private Shared Sub Extra()

' RUN_STOP (not executed in this example):

```

12 Programming Examples

```
' - RUN starts the acquisition of data for the active
'   waveform display.
' - STOP stops the data acquisition and turns off AUTOSTORE.
oscp.DoCommand(":RUN")
oscp.DoCommand(":STOP")

' VIEW_BLANK (not executed in this example):
' - VIEW turns on (starts displaying) an active channel or
'   pixel memory.
' - BLANK turns off (stops displaying) a specified channel or
'   pixel memory.
oscp.DoCommand(":BLANK CHANNEL1")
oscp.DoCommand(":VIEW CHANNEL1")

' TIME_MODE (not executed in this example) - Set the time base
' mode to MAIN, DELAYED, XY or ROLL.
oscp.DoCommand(":TIMEbase:MODE MAIN")

End Sub

' Capture()
' -----
' This function prepares the scope for data acquisition and then
' uses the DIGITIZE MACRO to capture some data.

Private Shared Sub Capture()

' ACQUIRE_TYPE - Sets the acquisition mode. There are three
' acquisition types NORMAL, PEAK, or AVERAGE.
oscp.DoCommand(":ACQUIRE:TYPE NORMAL")

' ACQUIRE_COMPLETE - Specifies the minimum completion criteria
' for an acquisition. The parameter determines the percentage
' of time buckets needed to be "full" before an acquisition is
' considered to be complete.
oscp.DoCommand(":ACQUIRE:COMPLETE 100")

' DIGITIZE - Used to acquire the waveform data for transfer
' over the interface. Sending this command causes an
' acquisition to take place with the resulting data being
' placed in the buffer.

' NOTE! The use of the DIGITIZE command is highly recommended
' as it will ensure that sufficient data is available for
' measurement. Keep in mind when the oscilloscope is running,
' communication with the computer interrupts data acquisition.
' Setting up the oscilloscope over the bus causes the data
' buffers to be cleared and internal hardware to be
' reconfigured.
' If a measurement is immediately requested there may not have
' been enough time for the data acquisition process to collect
' data and the results may not be accurate. An error value of
' 9.9E+37 may be returned over the bus in this situation.
'

oscp.DoCommand(":DIGITIZE CHANNEL1")
End Sub
```

```

' Analyze()
' -----
' In this example we will do the following:
' - Save the system setup to a file for restoration at a later
'   time.
' - Save the oscilloscope display to a file which can be
'   printed.
' - Make single channel measurements.

Private Shared Sub Analyze()

    ' Results array.
    Dim ResultsArray As Byte()
    ' Number of bytes returned from instrument.
    Dim nLength As Integer

    ' SAVE_SYSTEM_SETUP - The :SYSTEM:SETup? query returns a
    ' program message that contains the current state of the
    ' instrument. Its format is a definite-length binary block,
    ' for example,
    '   #800002204<setup string><NL>
    ' where the setup string is 2204 bytes in length.
    Console.WriteLine("Saving oscilloscope setup to " _
        + "c:\scope\config\setup.dat")
    If File.Exists("c:\scope\config\setup.dat") Then
        File.Delete("c:\scope\config\setup.dat")
    End If

    ' Query and read setup string.
    nLength = oscp.DoQueryIEEEBlock(":SYSTEM:SETup?", ResultsArray)
    Console.WriteLine("Read oscilloscope setup ({0} bytes).", _
        nLength)

    ' Write setup string to file.
    File.WriteAllBytes("c:\scope\config\setup.dat", ResultsArray)
    Console.WriteLine("Wrote setup string ({0} bytes) to file.", _
        nLength)

    ' RESTORE_SYSTEM_SETUP - Uploads a previously saved setup
    ' string to the oscilloscope.
    Dim dataArray As Byte()
    Dim nBytesWritten As Integer

    ' Read setup string from file.
    dataArray = File.ReadAllBytes("c:\scope\config\setup.dat")
    Console.WriteLine("Read setup string ({0} bytes) from file.", _
        dataArray.Length)

    ' Restore setup string.
    nBytesWritten = oscp.DoCommandIEEEBlock(":SYSTEM:SETup", _
        dataArray)
    Console.WriteLine("Restored setup string ({0} bytes).", _
        nBytesWritten)

    ' IMAGE_TRANSFER - In this example, we query for the screen
    ' data with the ":DISPLAY:DATA?" query. The .png format

```

12 Programming Examples

```
' data is saved to a file in the local file system.
Console.WriteLine("Transferring screen image to " _
    + "c:\scope\data\screen.png")
If File.Exists("c:\scope\data\screen.png") Then
    File.Delete("c:\scope\data\screen.png")
End If

' Increase I/O timeout to fifteen seconds.
oscpc.SetTimeoutSeconds(15)

' Get the screen data in PNG format.
nLength = _
    oscpc.DoQueryIEEEBlock(":DISPlay:DATA? PNG, SCReen, COlor", _
        ResultsArray)
Console.WriteLine("Read screen image ({0} bytes).", nLength)

' Store the screen data in a file.
File.WriteAllBytes("c:\scope\data\screen.png", ResultsArray)
Console.WriteLine("Wrote screen image ({0} bytes) to file.", _
    nLength)

' Return I/O timeout to five seconds.
oscpc.SetTimeoutSeconds(5)

' MEASURE - The commands in the MEASURE subsystem are used to
' make measurements on displayed waveforms.

' Set source to measure.
oscpc.DoCommand(":MEASure:SOURce CHANnel1")

' Query for frequency.
Dim fResults As Double
fResults = oscpc.DoQueryValue(":MEASure:FREQuency?")
Console.WriteLine("The frequency is: {0:F4} kHz", _
    fResults / 1000)

' Query for peak to peak voltage.
fResults = oscpc.DoQueryValue(":MEASure:VPP?")
Console.WriteLine("The peak to peak voltage is: {0:F2} V", _
    fResults)

' WAVEFORM_DATA - Get waveform data from oscilloscope. To
' obtain waveform data, you must specify the WAVEFORM
' parameters for the waveform data prior to sending the
' ":WAVEFORM:DATA?" query.
'
' Once these parameters have been sent, the
' ":WAVEFORM:PREAMBLE?" query provides information concerning
' the vertical and horizontal scaling of the waveform data.
'
' With the preamble information you can then use the
' ":WAVEFORM:DATA?" query and read the data block in the
' correct format.

' WAVE_FORMAT - Sets the data transmission mode for waveform
' data output. This command controls how the data is
' formatted when sent from the oscilloscope and can be set
```

```

' to WORD or BYTE format.

' Set waveform format to BYTE.
oscp.DoCommand(":WAVEform:FORMat BYTE")

' WAVE_POINTS - Sets the number of points to be transferred.
' The number of time points available is returned by the
' "ACQUIRE:POINTS?" query. This can be set to any binary
' fraction of the total time points available.
oscp.DoCommand(":WAVEform:POINTs 1000")

' GET_PREAMBLE - The preamble contains all of the current
' WAVEFORM settings returned in the form <preamble block><NL>
' where the <preamble block> is:
'   FORMAT      : int16 - 0 = BYTE, 1 = WORD, 2 = ASCII.
'   TYPE        : int16 - 0 = NORMAL, 1 = PEAK DETECT,
'               2 = AVERAGE.
'   POINTS      : int32 - number of data points transferred.
'   COUNT       : int32 - 1 and is always 1.
'   XINCREMENT  : float64 - time difference between data
'                   points.
'   XORIGIN     : float64 - always the first data point in
'                   memory.
'   XREFERENCE  : int32 - specifies the data point associated
'                   with the x-origin.
'   YINCREMENT  : float32 - voltage difference between data
'                   points.
'   YORIGIN     : float32 - value of the voltage at center
'                   screen.
'   YREFERENCE  : int32 - data point where y-origin occurs.
Console.WriteLine("Reading preamble.")
Dim fResultsArray As Double()
fResultsArray = oscp.DoQueryValues(":WAVEform:PREAmble?")

Dim fFormat As Double = fResultsArray(0)
Console.WriteLine("Preamble FORMat: {0:e}", fFormat)

Dim fType As Double = fResultsArray(1)
Console.WriteLine("Preamble TYPE: {0:e}", fType)

Dim fPoints As Double = fResultsArray(2)
Console.WriteLine("Preamble POINTs: {0:e}", fPoints)

Dim fCount As Double = fResultsArray(3)
Console.WriteLine("Preamble COUNT: {0:e}", fCount)

Dim fXincrement As Double = fResultsArray(4)
Console.WriteLine("Preamble XINCrement: {0:e}", fXincrement)

Dim fXorigin As Double = fResultsArray(5)
Console.WriteLine("Preamble XORigin: {0:e}", fXorigin)

Dim fXreference As Double = fResultsArray(6)
Console.WriteLine("Preamble XREFerence: {0:e}", fXreference)

Dim fYincrement As Double = fResultsArray(7)
Console.WriteLine("Preamble YINCrement: {0:e}", fYincrement)

```

```

Dim fYorigin As Double = fResultsArray(8)
Console.WriteLine("Preamble YORigin: {0:e}", fYorigin)

Dim fYreference As Double = fResultsArray(9)
Console.WriteLine("Preamble YREFerence: {0:e}", fYreference)

' QUERY_WAVE_DATA - Outputs waveform records to the controller
' over the interface that is stored in a buffer previously
' specified with the ":WAVEform:SOURce" command.

' READ_WAVE_DATA - The wave data consists of two parts: the
' header, and the actual waveform data followed by a
' New Line (NL) character. The query data has the following
' format:
'
' <header><waveform data block><NL>
'
' Where:
'
' <header> = #800002048 (this is an example header)
'
' The "#8" may be stripped off of the header and the remaining
' numbers are the size, in bytes, of the waveform data block.
' The size can vary depending on the number of points acquired
' for the waveform which can be set using the
' ":WAVEFORM:POINTS" command. You may then read that number
' of bytes from the oscilloscope; then, read the following NL
' character to terminate the query.

' Read waveform data.
nLength = oscp.DoQueryIEEEBlock(":WAVEform:DATA?", ResultsArray)
Console.WriteLine("Read waveform data ({0} bytes).", nLength)

' Make some calculations from the preamble data.
Dim fVdiv As Double = 32 * fYincrement
Dim fOffset As Double = fYorigin
Dim fSdiv As Double = fPoints * fXincrement / 10
Dim fDelay As Double = (fPoints / 2) * fXincrement + fXorigin

' Print them out...
Console.WriteLine("Scope Settings for Channel 1:")
Console.WriteLine("Volts per Division = {0:f}", fVdiv)
Console.WriteLine("Offset = {0:f}", fOffset)
Console.WriteLine("Seconds per Division = {0:e}", fSdiv)
Console.WriteLine("Delay = {0:e}", fDelay)

' Print the waveform voltage at selected points:
Dim i As Integer = 0
While i < 1000
    Console.WriteLine("Data point {0:d} = {1:f2} Volts at " + _
        "{2:f10} Seconds", i, _
        (CSng(ResultsArray(i)) - fYreference) * fYincrement + _
        fYorigin, _
        (CSng(i) - fXreference) * fXincrement + fXorigin)
    i = i + 50
End While

```

```

' SAVE_WAVE_DATA - saves the waveform data to a CSV format
' file named "waveform.csv".
If File.Exists("c:\scope\data\waveform.csv") Then
    File.Delete("c:\scope\data\waveform.csv")
End If

Dim writer As StreamWriter = _
    File.CreateText("c:\scope\data\waveform.csv")
For index As Integer = 0 To 999
    writer.WriteLine("{0:E}, {1:f6}", _
        (CSng(index) - fXreference) * fXincrement + fXorigin, _
        (CSng(ResultsArray(index)) - fYreference) * fYincrement _
        + fYorigin)
Next
writer.Close()
End Sub
End Class

Class VisaInstrument
    Private m_nResourceManager As Integer
    Private m_nSession As Integer
    Private m_strVisaAddress As String

    ' Constructor.
    Public Sub New(ByVal strVisaAddress As String)
        ' Save VISA address in member variable.
        m_strVisaAddress = strVisaAddress

        ' Open the default VISA resource manager.
        OpenResourceManager()

        ' Open a VISA resource session.
        OpenSession()

        ' Clear the interface.
        Dim nViStatus As Integer
        nViStatus = visa32.viClear(m_nSession)
    End Sub

    Public Sub DoCommand(ByVal strCommand As String)
        ' Send the command.
        VisaSendCommandOrQuery(strCommand)

        ' Check for instrument errors (another command and result).
        CheckForInstrumentErrors(strCommand)
    End Sub

    Public Function DoCommandIEEEBlock(ByVal strCommand As String, _
        ByVal dataArray As Byte()) As Integer
        ' Send the command to the device.
        Dim strCommandAndLength As String
        Dim nViStatus As Integer
        Dim nLength As Integer
        Dim nBytesWritten As Integer

        nLength = dataArray.Length

```

12 Programming Examples

```
strCommandAndLength = [String].Format("{0} #8{1:D8}", _
    strCommand, nLength)

' Write first part of command to formatted I/O write buffer.
nViStatus = visa32.viPrintf(m_nSession, strCommandAndLength)
CheckVisaStatus(nViStatus)

' Write the data to the formatted I/O write buffer.
nViStatus = visa32.viBufWrite(m_nSession, dataArray, nLength, _
    nBytesWritten)
CheckVisaStatus(nViStatus)

' Write command termination character.
nViStatus = visa32.viPrintf(m_nSession, "" & Chr(10) & "")
CheckVisaStatus(nViStatus)

' Check for instrument errors (another command and result).
CheckForInstrumentErrors(strCommand)

Return nBytesWritten
End Function

Public Function DoQueryString(ByVal strQuery As String) _
    As StringBuilder
    ' Send the query.
    VisaSendCommandOrQuery(strQuery)

    ' Get the result string.
    Dim strResults As New StringBuilder(1000)
    strResults = VisaGetResultString()

    ' Check for instrument errors (another command and result).
    CheckForInstrumentErrors(strQuery)

    ' Return string results.
    Return strResults
End Function

Public Function DoQueryValue(ByVal strQuery As String) As Double
    ' Send the query.
    VisaSendCommandOrQuery(strQuery)

    ' Get the result string.
    Dim fResults As Double
    fResults = VisaGetResultValue()

    ' Check for instrument errors (another command and result).
    CheckForInstrumentErrors(strQuery)

    ' Return string results.
    Return fResults
End Function

Public Function DoQueryValues(ByVal strQuery As String) As Double()
    ' Send the query.
    VisaSendCommandOrQuery(strQuery)
```



```

' Get the result string.
Dim fResultsArray As Double()
fResultsArray = VisaGetResultValues()

' Check for instrument errors (another command and result).
CheckForInstrumentErrors(strQuery)

' Return string results.
Return fResultsArray
End Function

Public Function DoQueryIEEEBlock(ByVal strQuery As String, _
    ByRef ResultsArray As Byte()) As Integer
' Send the query.
VisaSendCommandOrQuery(strQuery)

' Get the result string.
Dim length As Integer
' Number of bytes returned from instrument.
length = VisaGetResultIEEEBlock(ResultsArray)

' Check for instrument errors (another command and result).
CheckForInstrumentErrors(strQuery)

' Return string results.
Return length
End Function

Private Sub CheckForInstrumentErrors(ByVal strCommand As String)
' Check for instrument errors.
Dim strInstrumentError As New StringBuilder(1000)
Dim bFirstError As Boolean = True
Do
    VisaSendCommandOrQuery(":SYSTem:ERRor?")
    strInstrumentError = VisaGetResultString()

    If strInstrumentError.ToString() <> _
        "+0,""No error"" & Chr(10) & "" Then
        If bFirstError Then
            Console.WriteLine("ERROR(s) for command '{0}': ", _
                strCommand)
            bFirstError = False
        End If
        Console.Write(strInstrumentError)
    End If
Loop While strInstrumentError.ToString() <> _
    "+0,""No error"" & Chr(10) & ""
End Sub

Private Sub VisaSendCommandOrQuery(ByVal strCommandOrQuery _
    As String)
' Send command or query to the device.
Dim strWithNewline As String
strWithNewline = [String].Format("{0}" & Chr(10) & "", _
    strCommandOrQuery)
Dim nViStatus As Integer
nViStatus = visa32.viPrintf(m_nSession, strWithNewline)

```

```

    CheckVisaStatus(nViStatus)
End Sub

Private Function VisaGetResultString() As StringBuilder
    Dim strResults As New StringBuilder(1000)

    ' Read return value string from the device.
    Dim nViStatus As Integer
    nViStatus = visa32.viScanf(m_nSession, "%1000t", strResults)
    CheckVisaStatus(nViStatus)

    Return strResults
End Function

Private Function VisaGetResultValue() As Double
    Dim fResults As Double = 0

    ' Read return value string from the device.
    Dim nViStatus As Integer
    nViStatus = visa32.viScanf(m_nSession, "%lf", fResults)
    CheckVisaStatus(nViStatus)

    Return fResults
End Function

Private Function VisaGetResultValues() As Double()
    Dim fResultsArray As Double()
    fResultsArray = New Double(9) {}

    ' Read return value string from the device.
    Dim nViStatus As Integer
    nViStatus = visa32.viScanf(m_nSession, _
        "%,10lf" & Chr(10) & "", fResultsArray)
    CheckVisaStatus(nViStatus)

    Return fResultsArray
End Function

Private Function VisaGetResultIEEEBlock(ByRef ResultsArray _
    As Byte()) As Integer
    ' Results array, big enough to hold a PNG.
    ResultsArray = New Byte(299999) {}
    Dim length As Integer
    ' Number of bytes returned from instrument.
    ' Set the default number of bytes that will be contained in
    ' the ResultsArray to 300,000 (300kB).
    length = 300000

    ' Read return value string from the device.
    Dim nViStatus As Integer
    nViStatus = visa32.viScanf(m_nSession, "%#b", length, _
        ResultsArray)
    CheckVisaStatus(nViStatus)

    ' Write and read buffers need to be flushed after IEEE block?
    nViStatus = visa32.viFlush(m_nSession, visa32.VI_WRITE_BUF)
    CheckVisaStatus(nViStatus)

```

```

    nViStatus = visa32.viFlush(m_nSession, visa32.VI_READ_BUF)
    CheckVisaStatus(nViStatus)

    Return length
End Function

Private Sub OpenResourceManager()
    Dim nViStatus As Integer
    nViStatus = visa32.viOpenDefaultRM(Me.m_nResourceManager)
    If nViStatus < visa32.VI_SUCCESS Then
        Throw New _
            ApplicationException("Failed to open Resource Manager")
    End If
End Sub

Private Sub OpenSession()
    Dim nViStatus As Integer
    nViStatus = visa32.viOpen(Me.m_nResourceManager, _
        Me.m_strVisaAddress, visa32.VI_NO_LOCK, _
        visa32.VI_TMO_IMMEDIATE, Me.m_nSession)
    CheckVisaStatus(nViStatus)
End Sub

Public Sub SetTimeoutSeconds(ByVal nSeconds As Integer)
    Dim nViStatus As Integer
    nViStatus = visa32.viSetAttribute(Me.m_nSession, _
        visa32.VI_ATTR_TMO_VALUE, nSeconds * 1000)
    CheckVisaStatus(nViStatus)
End Sub

Public Sub CheckVisaStatus(ByVal nViStatus As Integer)
    ' If VISA error, throw exception.
    If nViStatus < visa32.VI_SUCCESS Then
        Dim strError As New StringBuilder(256)
        visa32.viStatusDesc(Me.m_nResourceManager, nViStatus, strError)
        Throw New ApplicationException(strError.ToString())
    End If
End Sub

Public Sub Close()
    If m_nSession <> 0 Then
        visa32.viClose(m_nSession)
    End If
    If m_nResourceManager <> 0 Then
        visa32.viClose(m_nResourceManager)
    End If
End Sub
End Class
End Namespace

```

VISA COM Examples

- ["VISA COM Example in Visual Basic"](#) on page 828
- ["VISA COM Example in C#"](#) on page 838
- ["VISA COM Example in Visual Basic .NET"](#) on page 849

VISA COM Example in Visual Basic

To run this example in Visual Basic for Applications (VBA):

- 1 Start the application that provides Visual Basic for Applications (for example, Microsoft Excel).
- 2 Press ALT+F11 to launch the Visual Basic editor.
- 3 Reference the Agilent VISA COM library:
 - a Choose **Tools>References...** from the main menu.
 - b In the References dialog, check the "VISA COM 3.0 Type Library".
 - c Click **OK**.
- 4 Choose **Insert>Module**.
- 5 Cut-and-paste the code that follows into the editor.
- 6 Edit the program to use the VISA address of your oscilloscope, and save the changes.
- 7 Run the program.

```
'
' Agilent VISA COM Example in Visual Basic
' -----
' This program illustrates most of the commonly used programming
' features of your Agilent oscilloscopes.
' -----

Option Explicit

Public myMgr As VisaComLib.ResourceManager
Public myScope As VisaComLib.FormattedIO488
Public varQueryResult As Variant
Public strQueryResult As String

'
' MAIN PROGRAM
' -----
' This example shows the fundamental parts of a program (initialize,
' capture, analyze).
'
' The commands sent to the oscilloscope are written in both long and
' short form. Both forms are acceptable.
'
' The input signal is the probe compensation signal from the front
' panel of the oscilloscope connected to channel 1.
```

```

'
' If you are using a different signal or different channels, these
' commands may not work as explained in the comments.
' -----

Sub Main()

    On Error GoTo VisaComError

    ' Create the VISA COM I/O resource.
    Set myMgr = New VisaComLib.ResourceManager
    Set myScope = New VisaComLib.FormattedIO488

    ' GPIB.
    'Set myScope.IO = myMgr.Open("GPIB0::7::INSTR")

    ' LAN.
    'Set myScope.IO = myMgr.Open("TCPIP0::a-mso6102-90541::inst0::INSTR")

    ' USB.
    Set myScope.IO = myMgr.Open("USB0::2391::5970::30D3090541::0::INSTR")

    ' Initialize - Initialization will start the program with the
    ' oscilloscope in a known state.
    Initialize

    ' Capture - After initialization, you must make waveform data
    ' available to analyze. To do this, capture the data using the
    ' DIGITIZE command.
    Capture

    ' Analyze - Once the waveform has been captured, it can be analyzed.
    ' There are many parts of a waveform to analyze. This example shows
    ' some of the possible ways to analyze various parts of a waveform.
    Analyze

    Exit Sub

VisaComError:
    MsgBox "VISA COM Error:" + vbCrLf + Err.Description

End Sub

'
' Initialize
' -----
' Initialize will start the program with the oscilloscope in a known
' state. This is required because some uninitialized conditions could
' cause the program to fail or not perform as expected.
'
' In this example, we initialize the following:
' - Oscilloscope
' - Channel 1 range
' - Display Grid
' - Timebase reference, range, and delay
' - Trigger mode and type
'

```

12 Programming Examples

```
' There are also some additional initialization commands, which are
' not used, but shown for reference.
' -----

Private Sub Initialize()

    On Error GoTo VisaComError

    ' Clear the interface.
    myScope.IO.Clear

    ' RESET - This command puts the oscilloscope into a known state.
    ' This statement is very important for programs to work as expected.
    ' Most of the following initialization commands are initialized by
    ' *RST. It is not necessary to reinitialize them unless the default
    ' setting is not suitable for your application.
    myScope.WriteString "*RST"    ' Reset the oscilloscope to the defaults.

    ' AUTOSCALE - This command evaluates all the input signals and sets
    ' the correct conditions to display all of the active signals.

    ' Same as pressing the Autoscale key.
    myScope.WriteString ":AUTOSCALE"

    ' CHANNEL_PROBE - Sets the probe attenuation factor for the selected
    ' channel. The probe attenuation factor may be set from 0.1 to 1000.
    myScope.WriteString ":CHAN1:PROBE 10"    ' Set Probe to 10:1.

    ' CHANNEL_RANGE - Sets the full scale vertical range in volts. The
    ' range value is 8 times the volts per division.

    ' Set the vertical range to 8 volts.
    myScope.WriteString ":CHANNEL1:RANGE 8"

    ' TIME_RANGE - Sets the full scale horizontal time in seconds. The
    ' range value is 10 times the time per division.

    ' Set the time range to 0.002 seconds.
    myScope.WriteString ":TIM:RANG 2e-3"

    ' TIME_REFERENCE - Possible values are LEFT and CENTER.
    ' - LEFT sets the display reference on time division from the left.
    ' - CENTER sets the display reference to the center of the screen.

    ' Set reference to center.
    myScope.WriteString ":TIMEBASE:REFERENCE CENTER"

    ' TRIGGER_TV_SOURCE - Selects the channel that actually produces the
    ' TV trigger. Any channel can be selected.
    myScope.WriteString ":TRIGGER:TV:SOURCE CHANNEL1"

    ' TRIGGER_MODE - Set the trigger mode to EDGE, GLITCh, PATtern, CAN,
    ' DURATION, IIC, LIN, SEQuence, SPI, TV, or USB.

    ' Set the trigger mode to EDGE.
    myScope.WriteString ":TRIGGER:MODE EDGE"
```

```

' TRIGGER_EDGE_SLOPE - Sets the slope of the edge for the trigger.

' Set the slope to positive.
myScope.WriteString ":TRIGGER:EDGE:SLOPE POSITIVE"

' The following commands are not executed and are shown for reference
' purposes only. To execute these commands, uncomment them.

' RUN_STOP - (not executed in this example)
' - RUN starts the acquisition of data for the active waveform
'   display.
' - STOP stops the data acquisition and turns off AUTOSTORE.
' myScope.WriteString ":RUN"      ' Start data acquisition.
' myScope.WriteString ":STOP"    ' Stop the data acquisition.

' VIEW_BLANK - (not executed in this example)
' - VIEW turns on (starts displaying) a channel or pixel memory.
' - BLANK turns off (stops displaying) a channel or pixel memory.
' myScope.WriteString ":BLANK CHANNEL1"  ' Turn channel 1 off.
' myScope.WriteString ":VIEW CHANNEL1"   ' Turn channel 1 on.

' TIMEBASE_MODE - (not executed in this example)
' Set the time base mode to MAIN, DELAYED, XY, or ROLL.

' Set time base mode to main.
' myScope.WriteString ":TIMEBASE:MODE MAIN"

Exit Sub

VisaComError:
  MsgBox "VISA COM Error:" + vbCrLf + Err.Description

End Sub

'
' Capture
' -----
' We will capture the waveform using the digitize command.
' -----

Private Sub Capture()

  On Error GoTo VisaComError

  ' ACQUIRE_TYPE - Sets the acquisition mode, which can be NORMAL,
  ' PEAK, or AVERAGE.
  myScope.WriteString ":ACQUIRE:TYPE NORMAL"

  ' ACQUIRE_COMPLETE - Specifies the minimum completion criteria for
  ' an acquisition. The parameter determines the percentage of time
  ' buckets needed to be "full" before an acquisition is considered
  ' to be complete.
  myScope.WriteString ":ACQUIRE:COMPLETE 100"

  ' DIGITIZE - Used to acquire the waveform data for transfer over
  ' the interface. Sending this command causes an acquisition to
  ' take place with the resulting data being placed in the buffer.

```

```

'
' NOTE! The DIGITIZE command is highly recommended for triggering
' modes other than SINGLE. This ensures that sufficient data is
' available for measurement. If DIGITIZE is used with single mode,
' the completion criteria may never be met. The number of points
' gathered in Single mode is related to the sweep speed, memory
' depth, and maximum sample rate. For example, take an oscilloscope
' with a 1000-point memory, a sweep speed of 10 us/div (100 us
' total time across the screen), and a 20 MSa/s maximum sample rate.
' 1000 divided by 100 us equals 10 MSa/s. Because this number is
' less than or equal to the maximum sample rate, the full 1000 points
' will be digitized in a single acquisition. Now, use 1 us/div
' (10 us across the screen). 1000 divided by 10 us equals 100 MSa/s;
' because this is greater than the maximum sample rate by 5 times,
' only 400 points (or 1/5 the points) can be gathered on a single
' trigger. Keep in mind when the oscilloscope is running,
' communication with the computer interrupts data acquisition.
' Setting up the oscilloscope over the bus causes the data buffers
' to be cleared and internal hardware to be reconfigured. If a
' measurement is immediately requested, there may have not been
' enough time for the data acquisition process to collect data,
' and the results may not be accurate. An error value of 9.9E+37
' may be returned over the bus in this situation.
'
myScope.WriteString ":DIGITIZE CHAN1"

Exit Sub

VisaComError:
    MsgBox "VISA COM Error:" + vbCrLf + Err.Description

End Sub

'
' Analyze
' -----
' In analyze, we will do the following:
' - Save the system setup to a file and restore it.
' - Save the waveform data to a file on the computer.
' - Make single channel measurements.
' - Save the oscilloscope display to a file that can be sent to a
'   printer.
' -----

Private Sub Analyze()

    On Error GoTo VisaComError

    ' SAVE_SYSTEM_SETUP - The :SYSTEM:SETUP? query returns a program
    ' message that contains the current state of the instrument. Its
    ' format is a definite-length binary block, for example,
    '   #800002204<setup string><NL>
    ' where the setup string is 2204 bytes in length.
    myScope.WriteString ":SYSTEM:SETUP?"
    varQueryResult = myScope.ReadIEEEBlock(BinaryType_UI1)
    CheckForInstrumentErrors ' After reading query results.
    ' Output setup string to a file:

```



```

Dim strPath As String
strPath = "c:\scope\config\setup.dat"
Close #1 ' If #1 is open, close it.
' Open file for output.
Open strPath For Binary Access Write Lock Write As #1
Put #1, , varQueryResult ' Write data.
Close #1 ' Close file.

' IMAGE_TRANSFER - In this example, we will query for the image data
' with ":DISPLAY:DATA?", read the data, and then save it to a file.
Dim byteData() As Byte
myScope.IO.Timeout = 15000
myScope.WriteString ":DISPLAY:DATA? BMP, SCREEN, COLOR"
byteData = myScope.ReadIEEEBlock(BinaryType_UI1)
' Output display data to a file:
strPath = "c:\scope\data\screen.bmp"
' Remove file if it exists.
If Len(Dir(strPath)) Then
    Kill strPath
End If
Close #1 ' If #1 is open, close it.
' Open file for output.
Open strPath For Binary Access Write Lock Write As #1
Put #1, , byteData ' Write data.
Close #1 ' Close file.
myScope.IO.Timeout = 5000

' RESTORE_SYSTEM_SETUP - Read the setup string from a file and write
' it back to the oscilloscope.
Dim varSetupString As Variant
strPath = "c:\scope\config\setup.dat"
Open strPath For Binary Access Read As #1 ' Open file for input.
Get #1, , varSetupString ' Read data.
Close #1 ' Close file.
' Write setup string back to oscilloscope using ":SYSTEM:SETUP"
' command:
myScope.WriteIEEEBlock ":SYSTEM:SETUP ", varSetupString
CheckForInstrumentErrors

' MEASURE - The commands in the MEASURE subsystem are used to make
' measurements on displayed waveforms.

' Source to measure.
myScope.WriteString ":MEASURE:SOURCE CHANNEL1"

' Query for frequency.
myScope.WriteString ":MEASURE:FREQUENCY?"
varQueryResult = myScope.ReadNumber ' Read frequency.
MsgBox "Frequency:" + vbCrLf + _
    FormatNumber(varQueryResult / 1000, 4) + " kHz"

' Query for duty cycle.
myScope.WriteString ":MEASURE:DUTYCYCLE?"
varQueryResult = myScope.ReadNumber ' Read duty cycle.
MsgBox "Duty cycle:" + vbCrLf + _
    FormatNumber(varQueryResult, 3) + "%"

```

```

' Query for risetime.
myScope.WriteString ":MEASURE:RISETIME?"
varQueryResult = myScope.ReadNumber ' Read risetime.
MsgBox "Risetime:" + vbCrLf + _
    FormatNumber(varQueryResult * 1000000, 4) + " us"

' Query for Peak to Peak voltage.
myScope.WriteString ":MEASURE:VPP?"
varQueryResult = myScope.ReadNumber ' Read VPP.
MsgBox "Peak to peak voltage:" + vbCrLf + _
    FormatNumber(varQueryResult, 4) + " V"

' Query for Vmax.
myScope.WriteString ":MEASURE:VMAX?"
varQueryResult = myScope.ReadNumber ' Read Vmax.
MsgBox "Maximum voltage:" + vbCrLf + _
    FormatNumber(varQueryResult, 4) + " V"

' WAVEFORM_DATA - To obtain waveform data, you must specify the
' WAVEFORM parameters for the waveform data prior to sending the
' ":WAVEFORM:DATA?" query. Once these parameters have been sent,
' the waveform data and the preamble can be read.
'
' WAVE_SOURCE - Selects the channel to be used as the source for
' the waveform commands.
myScope.WriteString ":WAVEFORM:SOURCE CHAN1"

' WAVE_POINTS - Specifies the number of points to be transferred
' using the ":WAVEFORM:DATA?" query.
myScope.WriteString ":WAVEFORM:POINTS 1000"

' WAVE_FORMAT - Sets the data transmission mode for the waveform
' data output. This command controls whether data is formatted in
' a word or byte format when sent from the oscilloscope.
Dim lngVSteps As Long
Dim intBytesPerData As Integer

' Data in range 0 to 65535.
myScope.WriteString ":WAVEFORM:FORMAT WORD"
lngVSteps = 65536
intBytesPerData = 2

' Data in range 0 to 255.
myScope.WriteString ":WAVEFORM:FORMAT BYTE"
lngVSteps = 256
intBytesPerData = 1

' GET_PREAMBLE - The preamble block contains all of the current
' WAVEFORM settings. It is returned in the form <preamble_block><NL>
' where <preamble_block> is:
'   FORMAT      : int16 - 0 = BYTE, 1 = WORD, 2 = ASCII.
'   TYPE        : int16 - 0 = NORMAL, 1 = PEAK DETECT, 2 = AVERAGE.
'   POINTS     : int32 - number of data points transferred.
'   COUNT      : int32 - 1 and is always 1.
'   XINCREMENT : float64 - time difference between data points.
'   XORIGIN    : float64 - always the first data point in memory.
'   XREFERENCE  : int32 - specifies the data point associated with

```

```

'           x-origin.
'   YINCREMENT   : float32 - voltage difference between data points.
'   YORIGIN      : float32 - value is the voltage at center screen.
'   YREFERENCE   : int32 - specifies the data point where y-origin
'                   occurs.

Dim Preamble()
Dim intFormat As Integer
Dim intType As Integer
Dim lngPoints As Long
Dim lngCount As Long
Dim dblXIncrement As Double
Dim dblXOrigin As Double
Dim lngXReference As Long
Dim sngYIncrement As Single
Dim sngYOrigin As Single
Dim lngYReference As Long
Dim strOutput As String

myScope.WriteString ":WAVEFORM:PREAMBLE?" ' Query for the preamble.
Preamble() = myScope.ReadList ' Read preamble information.
intFormat = Preamble(0)
intType = Preamble(1)
lngPoints = Preamble(2)
lngCount = Preamble(3)
dblXIncrement = Preamble(4)
dblXOrigin = Preamble(5)
lngXReference = Preamble(6)
sngYIncrement = Preamble(7)
sngYOrigin = Preamble(8)
lngYReference = Preamble(9)
strOutput = ""
'strOutput = strOutput + "Format = " + CStr(intFormat) + vbCrLf
'strOutput = strOutput + "Type = " + CStr(intType) + vbCrLf
'strOutput = strOutput + "Points = " + CStr(lngPoints) + vbCrLf
'strOutput = strOutput + "Count = " + CStr(lngCount) + vbCrLf
'strOutput = strOutput + "X increment = " + _
'           FormatNumber(dblXIncrement * 1000000) + _
'           " us" + vbCrLf
'strOutput = strOutput + "X origin = " + _
'           FormatNumber(dblXOrigin * 1000000) + _
'           " us" + vbCrLf
'strOutput = strOutput + "X reference = " + _
'           CStr(lngXReference) + vbCrLf
'strOutput = strOutput + "Y increment = " + _
'           FormatNumber(sngYIncrement * 1000) + _
'           " mV" + vbCrLf
'strOutput = strOutput + "Y origin = " + _
'           FormatNumber(sngYOrigin) + " V" + vbCrLf
'strOutput = strOutput + "Y reference = " + _
'           CStr(lngYReference) + vbCrLf
strOutput = strOutput + "Volts/Div = " + _
'           FormatNumber(lngVSteps * sngYIncrement / 8) + _
'           " V" + vbCrLf
strOutput = strOutput + "Offset = " + _
'           FormatNumber(sngYOrigin) + " V" + vbCrLf
strOutput = strOutput + "Sec/Div = " + _
'           FormatNumber(lngPoints * dblXIncrement / 10 * _

```

12 Programming Examples

```
1000000) + " us" + vbCrLf
strOutput = strOutput + "Delay = " + _
            FormatNumber(((lngPoints / 2) * _
            dblXIncrement + dblXOrigin) * 1000000) + " us" + vbCrLf

' QUERY_WAVE_DATA - Outputs waveform data that is stored in a buffer.

' Query the oscilloscope for the waveform data.
myScope.WriteString ":WAV:DATA?"

' READ_WAVE_DATA - The wave data consists of two parts: the header,
' and the actual waveform data followed by a new line (NL) character.
' The query data has the following format:
'
' <header><waveform_data><NL>
'
' Where:
' <header> = #800001000 (This is an example header)
' The "#8" may be stripped off of the header and the remaining
' numbers are the size, in bytes, of the waveform data block. The
' size can vary depending on the number of points acquired for the
' waveform. You can then read that number of bytes from the
' oscilloscope and the terminating NL character.
'
Dim lngI As Long
Dim lngDataValue As Long

' Unsigned integer bytes.
varQueryResult = myScope.ReadIEEEBlock(BinaryType_UI1)
For lngI = 0 To UBound(varQueryResult) _
    Step (UBound(varQueryResult) / 20) ' 20 points.
    If intBytesPerData = 2 Then
        lngDataValue = varQueryResult(lngI) * 256 + _
            varQueryResult(lngI + 1) ' 16-bit value.
    Else
        lngDataValue = varQueryResult(lngI) ' 8-bit value.
    End If
    strOutput = strOutput + "Data point " + _
        CStr(lngI / intBytesPerData) + ", " + _
        FormatNumber((lngDataValue - lngYReference) * sngYIncrement + _
            sngYOrigin) + " V, " + _
        FormatNumber(((lngI / intBytesPerData - lngXReference) * _
            dblXIncrement + dblXOrigin) * 1000000) + " us" + vbCrLf
Next lngI
MsgBox "Waveform data:" + vbCrLf + strOutput

' Make a delay measurement between channel 1 and 2.
Dim dblChan1Edge1 As Double
Dim dblChan2Edge1 As Double
Dim dblChan1Edge2 As Double
Dim dblDelay As Double
Dim dblPeriod As Double
Dim dblPhase As Double

' Query time at 1st rising edge on ch1.
myScope.WriteString ":MEASURE:TEDGE? +1, CHAN1"
```

```

' Read time at edge 1 on ch 1.
dblChan1Edge1 = myScope.ReadNumber

' Query time at 1st rising edge on ch2.
myScope.WriteString ":MEASURE:TEDGE? +1, CHAN2"

' Read time at edge 1 on ch 2.
dblChan2Edge1 = myScope.ReadNumber

' Calculate delay time between ch1 and ch2.
dblDelay = dblChan2Edge1 - dblChan1Edge1

' Write calculated delay time to screen.
MsgBox "Delay = " + vbCrLf + CStr(dblDelay)

' Make a phase difference measurement between channel 1 and 2.

' Query time at 1st rising edge on ch1.
myScope.WriteString ":MEASURE:TEDGE? +2, CHAN1"

' Read time at edge 2 on ch 1.
dblChan1Edge2 = myScope.ReadNumber

' Calculate period of ch 1.
dblPeriod = dblChan1Edge2 - dblChan1Edge1

' Calculate phase difference between ch1 and ch2.
dblPhase = (dblDelay / dblPeriod) * 360
MsgBox "Phase = " + vbCrLf + CStr(dblPhase)

Exit Sub

VisaComError:
MsgBox "VISA COM Error:" + vbCrLf + Err.Description

End Sub

Private Sub CheckForInstrumentErrors()

On Error GoTo VisaComError

Dim strErrVal As String
Dim strOut As String

myScope.WriteString "SYSTEM:ERROR?" ' Query any errors data.
strErrVal = myScope.ReadString ' Read: Errnum,"Error String".
While Val(strErrVal) <> 0 ' End if find: 0,"No Error".
strOut = strOut + "INST Error: " + strErrVal
myScope.WriteString "SYSTEM:ERROR?" ' Request error message.
strErrVal = myScope.ReadString ' Read error message.
Wend

If Not strOut = "" Then
MsgBox strOut, vbExclamation, "INST Error Messages"
myScope.FlushWrite (False)
myScope.FlushRead

```

```
End If

Exit Sub

VisaComError:
    MsgBox "VISA COM Error: " + vbCrLf + Err.Description

End Sub
```

VISA COM Example in C#

To compile and run this example in Microsoft Visual Studio 2005:

- 1 Open Visual Studio.
- 2 Create a new Visual C#, Windows, Console Application project.
- 3 Cut-and-paste the code that follows into the C# source file.
- 4 Edit the program to use the VISA address of your oscilloscope.
- 5 Add a reference to the VISA COM 3.0 Type Library:
 - a Right-click the project you wish to modify (not the solution) in the Solution Explorer window of the Microsoft Visual Studio environment.
 - b Choose **Add Reference...**
 - c In the Add Reference dialog, select the **COM** tab.
 - d Select **VISA COM 3.0 Type Library**; then click **OK**.
- 6 Build and run the program.

For more information, see the VISA COM Help that comes with Agilent IO Libraries Suite 15.

```
/*
 * Agilent VISA COM Example in C#
 * -----
 * This program illustrates most of the commonly used programming
 * features of your Agilent oscilloscopes.
 * -----
 */

using System;
using System.IO;
using System.Text;
using Ivi.Visa.Interop;
using System.Runtime.InteropServices;

namespace InfiniiVision
{
    class VisaComInstrumentApp
    {
        private static VisaComInstrument myScope;

        public static void Main(string[] args)
```

```

{
    try
    {
        myScope = new
            VisaComInstrument("USB0::2391::5957::MY47250010::0::INSTR");

        Initialize();

        /* The extras function contains miscellaneous commands that
         * do not need to be executed for the proper operation of
         * this example. The commands in the extras function are
         * shown for reference purposes only.
         */
        /*
        // Extra();    // Uncomment to execute the extra function.
        Capture();
        Analyze();
        */
    }
    catch (System.ApplicationException err)
    {
        Console.WriteLine("*** VISA Error Message : " + err.Message);
    }
    catch (System.SystemException err)
    {
        Console.WriteLine("*** System Error Message : " + err.Message);
    }
    catch (System.Exception err)
    {
        System.Diagnostics.Debug.Fail("Unexpected Error");
        Console.WriteLine("*** Unexpected Error : " + err.Message);
    }
    finally
    {
        myScope.Close();
    }
}

/*
 * Initialize()
 * -----
 * This function initializes both the interface and the
 * oscilloscope to a known state.
 */
private static void Initialize()
{
    string strResults;

    /* RESET - This command puts the oscilloscope into a known
     * state. This statement is very important for programs to
     * work as expected. Most of the following initialization
     * commands are initialized by *RST. It is not necessary to
     * reinitialize them unless the default setting is not suitable
     * for your application.
     */
    myScope.DoCommand("*RST");    // Reset the to the defaults.
    myScope.DoCommand("*CLS");    // Clear the status data structures.

    /* IDN - Ask for the device's *IDN string.

```

12 Programming Examples

```
    */
strResults = myScope.DoQueryString("*IDN?");

// Display results.
Console.WriteLine("Result is: {0}", strResults);

/* AUTOSCALE - This command evaluates all the input signals
 * and sets the correct conditions to display all of the
 * active signals.
 */
myScope.DoCommand(":AUToscale");

/* CHANNEL_PROBE - Sets the probe attenuation factor for the
 * selected channel. The probe attenuation factor may be from
 * 0.1 to 1000.
 */
myScope.DoCommand(":CHANnel1:PROBe 10");

/* CHANNEL_RANGE - Sets the full scale vertical range in volts.
 * The range value is eight times the volts per division.
 */
myScope.DoCommand(":CHANnel1:RANGe 8");

/* TIME_RANGE - Sets the full scale horizontal time in seconds.
 * The range value is ten times the time per division.
 */
myScope.DoCommand(":TIMEbase:RANGe 2e-3");

/* TIME_REFERENCE - Possible values are LEFT and CENTER:
 * - LEFT sets the display reference one time division from
 *   the left.
 * - CENTER sets the display reference to the center of the
 *   screen.
 */
myScope.DoCommand(":TIMEbase:REFerence CENTER");

/* TRIGGER_SOURCE - Selects the channel that actually produces
 * the TV trigger. Any channel can be selected.
 */
myScope.DoCommand(":TRIGger:TV:SOURCe CHANnel1");

/* TRIGGER_MODE - Set the trigger mode to, EDGE, GLITCh,
 * PATtern, CAN, DURation, IIC, LIN, SEQUENCE, SPI, TV,
 * UART, or USB.
 */
myScope.DoCommand(":TRIGger:MODE EDGE");

/* TRIGGER_EDGE_SLOPE - Set the slope of the edge for the
 * trigger to either POSITIVE or NEGATIVE.
 */
myScope.DoCommand(":TRIGger:EDGE:SLOPe Positive");
}

/*
 * Extra()
 * -----
 * The commands in this function are not executed and are shown
 */
```



```

* for reference purposes only. To execute these commands, call
* this function from main.
*/
private static void Extra()
{
    /* RUN_STOP (not executed in this example):
    * - RUN starts the acquisition of data for the active
    *   waveform display.
    * - STOP stops the data acquisition and turns off AUTOSTORE.
    */
    myScope.DoCommand(":RUN");
    myScope.DoCommand(":STOP");

    /* VIEW_BLANK (not executed in this example):
    * - VIEW turns on (starts displaying) an active channel or
    *   pixel memory.
    * - BLANK turns off (stops displaying) a specified channel or
    *   pixel memory.
    */
    myScope.DoCommand(":BLANk CHANnel1");
    myScope.DoCommand(":VIEW CHANnel1");

    /* TIME_MODE (not executed in this example) - Set the time base
    * mode to MAIN, DELAYED, XY or ROLL.
    */
    myScope.DoCommand(":TIMEbase:MODE MAIN");
}

/*
* Capture()
* -----
* This function prepares the scope for data acquisition and then
* uses the DIGITIZE MACRO to capture some data.
*/
private static void Capture()
{
    /* ACQUIRE_TYPE - Sets the acquisition mode. There are three
    * acquisition types NORMAL, PEAK, or AVERAGE.
    */
    myScope.DoCommand(":ACquire:TYPE NORMal");

    /* ACQUIRE_COMPLETE - Specifies the minimum completion criteria
    * for an acquisition. The parameter determines the percentage
    * of time buckets needed to be "full" before an acquisition is
    * considered to be complete.
    */
    myScope.DoCommand(":ACquire:COMplete 100");

    /* DIGITIZE - Used to acquire the waveform data for transfer
    * over the interface. Sending this command causes an
    * acquisition to take place with the resulting data being
    * placed in the buffer.
    */

    /* NOTE! The use of the DIGITIZE command is highly recommended
    * as it will ensure that sufficient data is available for
    * measurement. Keep in mind when the oscilloscope is running,

```

```

    * communication with the computer interrupts data acquisition.
    * Setting up the oscilloscope over the bus causes the data
    * buffers to be cleared and internal hardware to be
    * reconfigured.
    * If a measurement is immediately requested there may not have
    * been enough time for the data acquisition process to collect
    * data and the results may not be accurate. An error value of
    * 9.9E+37 may be returned over the bus in this situation.
    */
myScope.DoCommand(":DIGitize CHANnel1");
}

/*
 * Analyze()
 * -----
 * In this example we will do the following:
 * - Save the system setup to a file for restoration at a later
 *   time.
 * - Save the oscilloscope display to a file which can be
 *   printed.
 * - Make single channel measurements.
 */
private static void Analyze()
{
    byte[] ResultsArray;    // Results array.
    int nBytes;            // Number of bytes returned from instrument.

    /* SAVE_SYSTEM_SETUP - The :SYSTEM:SETup? query returns a
     * program message that contains the current state of the
     * instrument. Its format is a definite-length binary block,
     * for example,
     *   #800002204<setup string><NL>
     * where the setup string is 2204 bytes in length.
     */
    Console.WriteLine("Saving oscilloscope setup to " +
        "c:\\scope\\config\\setup.dat");
    if (File.Exists("c:\\scope\\config\\setup.dat"))
        File.Delete("c:\\scope\\config\\setup.dat");

    // Query and read setup string.
    ResultsArray = myScope.DoQueryIEEEBlock(":SYSTEM:SETup?");
    nBytes = ResultsArray.Length;
    Console.WriteLine("Read oscilloscope setup ({0} bytes).",
        nBytes);

    // Write setup string to file.
    File.WriteAllBytes("c:\\scope\\config\\setup.dat",
        ResultsArray);
    Console.WriteLine("Wrote setup string ({0} bytes) to file.",
        nBytes);

    /* RESTORE_SYSTEM_SETUP - Uploads a previously saved setup
     * string to the oscilloscope.
     */
    byte[] dataArray;

    // Read setup string from file.

```

```

dataArray = File.ReadAllBytes("c:\\scope\\config\\setup.dat");
Console.WriteLine("Read setup string ({0} bytes) from file.",
    dataArray.Length);

// Restore setup string.
myScope.DoCommandIEEEBlock(":SYSTem:SETup", dataArray);
Console.WriteLine("Restored setup string.");

/* IMAGE_TRANSFER - In this example, we query for the screen
 * data with the ":DISPLAY:DATA?" query. The .png format
 * data is saved to a file in the local file system.
 */
Console.WriteLine("Transferring screen image to " +
    "c:\\scope\\data\\screen.png");
if (File.Exists("c:\\scope\\data\\screen.png"))
    File.Delete("c:\\scope\\data\\screen.png");

// Increase I/O timeout to fifteen seconds.
myScope.SetTimeoutSeconds(15);

// Get the screen data in PNG format.
ResultsArray = myScope.DoQueryIEEEBlock(
    ":DISPlay:DATA? PNG, SCReen, COLor");
nBytes = ResultsArray.Length;
Console.WriteLine("Read screen image ({0} bytes).", nBytes);

// Store the screen data in a file.
File.WriteAllBytes("c:\\scope\\data\\screen.png",
    ResultsArray);
Console.WriteLine("Wrote screen image ({0} bytes) to file.",
    nBytes);

// Return I/O timeout to five seconds.
myScope.SetTimeoutSeconds(5);

/* MEASURE - The commands in the MEASURE subsystem are used to
 * make measurements on displayed waveforms.
 */

// Set source to measure.
myScope.DoCommand(":MEASure:SOURce CHANnel1");

// Query for frequency.
double fResults;
fResults = myScope.DoQueryValue(":MEASure:FREQuency?");
Console.WriteLine("The frequency is: {0:F4} kHz",
    fResults / 1000);

// Query for peak to peak voltage.
fResults = myScope.DoQueryValue(":MEASure:VPP?");
Console.WriteLine("The peak to peak voltage is: {0:F2} V",
    fResults);

/* WAVEFORM_DATA - Get waveform data from oscilloscope. To
 * obtain waveform data, you must specify the WAVEFORM
 * parameters for the waveform data prior to sending the
 * ":WAVEFORM:DATA?" query.

```

12 Programming Examples

```
*
* Once these parameters have been sent, the
* ":WAVEFORM:PREAmble?" query provides information concerning
* the vertical and horizontal scaling of the waveform data.
*
* With the preamble information you can then use the
* ":WAVEFORM:DATA?" query and read the data block in the
* correct format.
*/

/* WAVE_FORMAT - Sets the data transmission mode for waveform
* data output. This command controls how the data is
* formatted when sent from the oscilloscope and can be set
* to WORD or BYTE format.
*/

// Set waveform format to BYTE.
myScope.DoCommand(":WAVEform:FORMat BYTE");

/* WAVE_POINTS - Sets the number of points to be transferred.
* The number of time points available is returned by the
* "ACQUIRE:POINTS?" query. This can be set to any binary
* fraction of the total time points available.
*/
myScope.DoCommand(":WAVEform:POINTs 1000");

/* GET_PREAMBLE - The preamble contains all of the current
* WAVEFORM settings returned in the form <preamble block><NL>
* where the <preamble block> is:
*   FORMAT      : int16 - 0 = BYTE, 1 = WORD, 2 = ASCII.
*   TYPE        : int16 - 0 = NORMAL, 1 = PEAK DETECT,
*                 2 = AVERAGE.
*   POINTS      : int32 - number of data points transferred.
*   COUNT       : int32 - 1 and is always 1.
*   XINCREMENT  : float64 - time difference between data
*                 points.
*   XORIGIN     : float64 - always the first data point in
*                 memory.
*   XREFERENCE  : int32 - specifies the data point associated
*                 with the x-origin.
*   YINCREMENT  : float32 - voltage difference between data
*                 points.
*   YORIGIN     : float32 - value of the voltage at center
*                 screen.
*   YREFERENCE  : int32 - data point where y-origin occurs.
*/
Console.WriteLine("Reading preamble.");
double[] fResultsArray;
fResultsArray = myScope.DoQueryValues(":WAVEform:PREAmble?");

double fFormat = fResultsArray[0];
Console.WriteLine("Preamble FORMat: {0:e}", fFormat);

double fType = fResultsArray[1];
Console.WriteLine("Preamble TYPE: {0:e}", fType);

double fPoints = fResultsArray[2];
```

```

Console.WriteLine("Preamble POINTs: {0:e}", fPoints);

double fCount = fResultsArray[3];
Console.WriteLine("Preamble COUNT: {0:e}", fCount);

double fXincrement = fResultsArray[4];
Console.WriteLine("Preamble XINCrement: {0:e}", fXincrement);

double fXorigin = fResultsArray[5];
Console.WriteLine("Preamble XORigin: {0:e}", fXorigin);

double fXreference = fResultsArray[6];
Console.WriteLine("Preamble XREFerence: {0:e}", fXreference);

double fYincrement = fResultsArray[7];
Console.WriteLine("Preamble YINCrement: {0:e}", fYincrement);

double fYorigin = fResultsArray[8];
Console.WriteLine("Preamble YORigin: {0:e}", fYorigin);

double fYreference = fResultsArray[9];
Console.WriteLine("Preamble YREFerence: {0:e}", fYreference);

/* QUERY_WAVE_DATA - Outputs waveform records to the controller
 * over the interface that is stored in a buffer previously
 * specified with the ":WAVEform:SOURce" command.
 */

/* READ_WAVE_DATA - The wave data consists of two parts: the
 * header, and the actual waveform data followed by a
 * New Line (NL) character. The query data has the following
 * format:
 *
 * <header><waveform data block><NL>
 *
 * Where:
 *
 * <header> = #800002048 (this is an example header)
 *
 * The "#8" may be stripped off of the header and the remaining
 * numbers are the size, in bytes, of the waveform data block.
 * The size can vary depending on the number of points acquired
 * for the waveform which can be set using the
 * ":WAVEFORM:POINTS" command. You may then read that number
 * of bytes from the oscilloscope; then, read the following NL
 * character to terminate the query.
 */

// Read waveform data.
ResultsArray = myScope.DoQueryIEEEBlock(":WAVEform:DATA?");
nBytes = ResultsArray.Length;
Console.WriteLine("Read waveform data ({0} bytes).", nBytes);

// Make some calculations from the preamble data.
double fVdiv = 32 * fYincrement;
double fOffset = fYorigin;
double fSdiv = fPoints * fXincrement / 10;

```

```

double fDelay = (fPoints / 2) * fXincrement + fXorigin;

// Print them out...
Console.WriteLine("Scope Settings for Channel 1:");
Console.WriteLine("Volts per Division = {0:f}", fVdiv);
Console.WriteLine("Offset = {0:f}", fOffset);
Console.WriteLine("Seconds per Division = {0:e}", fSdiv);
Console.WriteLine("Delay = {0:e}", fDelay);

// Print the waveform voltage at selected points:
for (int i = 0; i < nBytes; i = i + (nBytes / 20))
{
    Console.WriteLine("Data point {0:d} = {1:f6} Volts at "
        + "{2:f10} Seconds", i,
        ((float)ResultsArray[i] - fYreference) * fYincrement +
        fYorigin,
        ((float)i - fXreference) * fXincrement + fXorigin);
}

/* SAVE_WAVE_DATA - saves the waveform data to a CSV format
 * file named "waveform.csv".
 */
if (File.Exists("c:\\scope\\data\\waveform.csv"))
    File.Delete("c:\\scope\\data\\waveform.csv");

StreamWriter writer =
    File.CreateText("c:\\scope\\data\\waveform.csv");
for (int i = 0; i < nBytes; i++)
{
    writer.WriteLine("{0:E}, {1:f6}",
        ((float)i - fXreference) * fXincrement + fXorigin,
        ((float)ResultsArray[i] - fYreference) * fYincrement +
        fYorigin);
}
writer.Close();
Console.WriteLine("Waveform data ({0} points) written to " +
    "c:\\scope\\data\\waveform.csv.", nBytes);
}
}

class VisaComInstrument
{
    private ResourceManagerClass m_ResourceManager;
    private FormattedIO488Class m_IoObject;
    private string m_strVisaAddress;

    // Constructor.
    public VisaComInstrument(string strVisaAddress)
    {
        // Save VISA address in member variable.
        m_strVisaAddress = strVisaAddress;

        // Open the default VISA COM IO object.
        OpenIo();

        // Clear the interface.
        m_IoObject.IO.Clear();
    }
}

```

```

}

public void DoCommand(string strCommand)
{
    // Send the command.
    m_IoObject.WriteString(strCommand, true);

    // Check for instrument errors.
    CheckForInstrumentErrors(strCommand);
}

public string DoQueryString(string strQuery)
{
    // Send the query.
    m_IoObject.WriteString(strQuery, true);

    // Get the result string.
    string strResults;
    strResults = m_IoObject.ReadString();

    // Check for instrument errors.
    CheckForInstrumentErrors(strQuery);

    // Return results string.
    return strResults;
}

public double DoQueryValue(string strQuery)
{
    // Send the query.
    m_IoObject.WriteString(strQuery, true);

    // Get the result number.
    double fResult;
    fResult = (double)m_IoObject.ReadNumber(
        IEEEASCIIType.ASCIIType_R8, true);

    // Check for instrument errors.
    CheckForInstrumentErrors(strQuery);

    // Return result number.
    return fResult;
}

public double[] DoQueryValues(string strQuery)
{
    // Send the query.
    m_IoObject.WriteString(strQuery, true);

    // Get the result numbers.
    double[] fResultsArray;
    fResultsArray = (double[])m_IoObject.ReadList(
        IEEEASCIIType.ASCIIType_R8, ",;");

    // Check for instrument errors.
    CheckForInstrumentErrors(strQuery);
}

```

```

    // Return result numbers.
    return fResultsArray;
}

public byte[] DoQueryIEEEBlock(string strQuery)
{
    // Send the query.
    m_IoObject.WriteString(strQuery, true);

    // Get the results array.
    byte[] ResultsArray;
    ResultsArray = (byte[])m_IoObject.ReadIEEEBlock(
        IEEEBinaryType.BinaryType_UI1, false, true);

    // Check for instrument errors.
    CheckForInstrumentErrors(strQuery);

    // Return results array.
    return ResultsArray;
}

public void DoCommandIEEEBlock(string strCommand,
    byte[] dataArray)
{
    // Send the command.
    m_IoObject.WriteIEEEBlock(strCommand, dataArray, true);

    // Check for instrument errors.
    CheckForInstrumentErrors(strCommand);
}

private void CheckForInstrumentErrors(string strCommand)
{
    string strInstrumentError;
    bool bFirstError = true;

    // Repeat until all errors are displayed.
    do
    {
        // Send the ":SYSTEM:ERROR?" query, and get the result string.
        m_IoObject.WriteString(":SYSTEM:ERROR?", true);
        strInstrumentError = m_IoObject.ReadString();

        // If there is an error, print it.
        if (strInstrumentError.ToString() != "+0,\"No error\"\n")
        {
            if (bFirstError)
            {
                // Print the command that caused the error.
                Console.WriteLine("ERROR(s) for command '{0}': ",
                    strCommand);
                bFirstError = false;
            }
            Console.Write(strInstrumentError);
        }
    } while (strInstrumentError.ToString() != "+0,\"No error\"\n");
}

```



```

private void OpenIo()
{
    m_ResourceManager = new ResourceManagerClass();
    m_IoObject = new FormattedIO488Class();

    // Open the default VISA COM IO object.
    try
    {
        m_IoObject.IO =
            (IMessage)m_ResourceManager.Open(m_strVisaAddress,
            AccessMode.NO_LOCK, 0, "");
    }
    catch (Exception e)
    {
        Console.WriteLine("An error occurred: {0}", e.Message);
    }
}

public void SetTimeoutSeconds(int nSeconds)
{
    m_IoObject.IO.Timeout = nSeconds * 1000;
}

public void Close()
{
    try
    {
        m_IoObject.IO.Close();
    }
    catch {}

    try
    {
        Marshal.ReleaseComObject(m_IoObject);
    }
    catch {}

    try
    {
        Marshal.ReleaseComObject(m_ResourceManager);
    }
    catch {}
}
}
}

```

VISA COM Example in Visual Basic .NET

To compile and run this example in Microsoft Visual Studio 2005:

- 1 Open Visual Studio.
- 2 Create a new Visual Basic, Windows, Console Application project.
- 3 Cut-and-paste the code that follows into the C# source file.

- 4 Edit the program to use the VISA address of your oscilloscope.
- 5 Add a reference to the VISA COM 3.0 Type Library:
 - a Right-click the project you wish to modify (not the solution) in the Solution Explorer window of the Microsoft Visual Studio environment.
 - b Choose **Add Reference...**
 - c In the Add Reference dialog, select the **COM** tab.
 - d Select **VISA COM 3.0 Type Library**; then click **OK**.
 - e Right-click the project you wish to modify (not the solution) in the Solution Explorer window of the Microsoft Visual Studio environment and choose **Properties**; then, select "InfiniiVision.VisaComInstrumentApp" as the **Startup object**.
- 6 Build and run the program.

For more information, see the VISA COM Help that comes with Agilent IO Libraries Suite 15.

```
'
' Agilent VISA COM Example in Visual Basic .NET
' -----
' This program illustrates most of the commonly used programming
' features of your Agilent oscilloscopes.
' -----

Imports System
Imports System.IO
Imports System.Text
Imports Ivi.Visa.Interop
Imports System.Runtime.InteropServices

Namespace InfiniiVision
  Class VisaComInstrumentApp
    Private Shared myScope As VisaComInstrument

    Public Shared Sub Main(ByVal args As String())
      Try
        myScope = New _
          VisaComInstrument("USB0::2391::5957::MY47250010::0::INSTR")

        Initialize()

        ' The extras function contains miscellaneous commands that
        ' do not need to be executed for the proper operation of
        ' this example. The commands in the extras function are
        ' shown for reference purposes only.

        ' Extra(); // Uncomment to execute the extra function.
        Capture()
        Analyze()
      Catch err As System.ApplicationException
        Console.WriteLine("*** VISA Error Message : " + err.Message)
      End Try
    End Sub
  End Class
End Namespace
```

```

Catch err As System.SystemException
    Console.WriteLine("*** System Error Message : " + err.Message)
Catch err As System.Exception
    System.Diagnostics.Debug.Fail("Unexpected Error")
    Console.WriteLine("*** Unexpected Error : " + err.Message)
Finally
    myScope.Close()
End Try
End Sub

```

```

' Initialize()
' -----
' This function initializes both the interface and the
' oscilloscope to a known state.

```

```

Private Shared Sub Initialize()
    Dim strResults As String

    ' RESET - This command puts the oscilloscope into a known
    ' state. This statement is very important for programs to
    ' work as expected. Most of the following initialization
    ' commands are initialized by *RST. It is not necessary to
    ' reinitialize them unless the default setting is not suitable
    ' for your application.

    ' Reset to the defaults.
    myScope.DoCommand("*RST")

    ' Clear the status data structures.
    myScope.DoCommand("*CLS")

    ' IDN - Ask for the device's *IDN string.
    strResults = myScope.DoQueryString("*IDN?")

    ' Display results.
    Console.WriteLine("Result is: {0}", strResults)

    ' AUTOSCALE - This command evaluates all the input signals
    ' and sets the correct conditions to display all of the
    ' active signals.
    myScope.DoCommand(":AUToscale")

    ' CHANNEL_PROBE - Sets the probe attenuation factor for the
    ' selected channel. The probe attenuation factor may be from
    ' 0.1 to 1000.
    myScope.DoCommand(":CHANnel1:PROBe 10")

    ' CHANNEL_RANGE - Sets the full scale vertical range in volts.
    ' The range value is eight times the volts per division.
    myScope.DoCommand(":CHANnel1:RANGe 8")

    ' TIME_RANGE - Sets the full scale horizontal time in seconds.
    ' The range value is ten times the time per division.
    myScope.DoCommand(":TIMebase:RANGe 2e-3")

    ' TIME_REFERENCE - Possible values are LEFT and CENTER:
    ' - LEFT sets the display reference one time division from

```

12 Programming Examples

```
' the left.
' - CENTER sets the display reference to the center of the
' screen.
myScope.DoCommand(":TIMEbase:REFEreNce CeNTEr")

' TRIGGER_SOURCE - Selects the channel that actually produces
' the TV trigger. Any channel can be selected.
myScope.DoCommand(":TRIGger:TV:SOURCe CHANnel1")

' TRIGGER_MODE - Set the trigger mode to, EDGE, GLITCh,
' PATTErn, CAN, DURation, IIC, LIN, SEQUence, SPI, TV,
' UART, or USB.
myScope.DoCommand(":TRIGger:MODE EDGE")

' TRIGGER_EDGE_SLOPE - Set the slope of the edge for the
' trigger to either POSITIVE or NEGATIVE.
myScope.DoCommand(":TRIGger:EDGE:SLOPe POSitive")

End Sub

'
' Extra()
' -----
' The commands in this function are not executed and are shown
' for reference purposes only. To execute these commands, call
' this function from main.
'

Private Shared Sub Extra()
' RUN_STOP (not executed in this example):
' - RUN starts the acquisition of data for the active
' waveform display.
' - STOP stops the data acquisition and turns off AUTOSTORE.
'

myScope.DoCommand(":RUN")
myScope.DoCommand(":STOP")

' VIEW_BLANK (not executed in this example):
' - VIEW turns on (starts displaying) an active channel or
' pixel memory.
' - BLANK turns off (stops displaying) a specified channel or
' pixel memory.
'

myScope.DoCommand(":BLANk CHANnel1")
myScope.DoCommand(":VIEW CHANnel1")

' TIME_MODE (not executed in this example) - Set the time base
' mode to MAIN, DELAYED, XY or ROLL.
'

myScope.DoCommand(":TIMEbase:MODE MAIN")
End Sub

' Capture()
' -----
```

```
' This function prepares the scope for data acquisition and then
' uses the DIGITIZE MACRO to capture some data.
```

```
Private Shared Sub Capture()
```

```
' ACQUIRE_TYPE - Sets the acquisition mode. There are three
' acquisition types NORMAL, PEAK, or AVERAGE.
myScope.DoCommand(":ACquire:TYPE NORMal")
```

```
' ACQUIRE_COMPLETE - Specifies the minimum completion criteria
' for an acquisition. The parameter determines the percentage
' of time buckets needed to be "full" before an acquisition is
' considered to be complete.
myScope.DoCommand(":ACquire:COMplete 100")
```

```
' DIGITIZE - Used to acquire the waveform data for transfer
' over the interface. Sending this command causes an
' acquisition to take place with the resulting data being
' placed in the buffer.
```

```
' NOTE! The use of the DIGITIZE command is highly recommended
' as it will ensure that sufficient data is available for
' measurement. Keep in mind when the oscilloscope is running,
' communication with the computer interrupts data acquisition.
' Setting up the oscilloscope over the bus causes the data
' buffers to be cleared and internal hardware to be
' reconfigured.
' If a measurement is immediately requested there may not have
' been enough time for the data acquisition process to collect
' data and the results may not be accurate. An error value of
' 9.9E+37 may be returned over the bus in this situation.
myScope.DoCommand(":DIGitize CHANnel1")
```

```
End Sub
```

```
' Analyze()
```

```
' -----
' In this example we will do the following:
' - Save the system setup to a file for restoration at a later
'   time.
' - Save the oscilloscope display to a file which can be
'   printed.
' - Make single channel measurements.
```

```
Private Shared Sub Analyze()
```

```
' Results array.
Dim ResultsArray As Byte()
```

```
' Number of bytes returned from instrument.
Dim nBytes As Integer
```

```
' SAVE_SYSTEM_SETUP - The :SYSTEM:SETup? query returns a
' program message that contains the current state of the
' instrument. Its format is a definite-length binary block,
' for example,
' #800002204<setup string><NL>
' where the setup string is 2204 bytes in length.
Console.WriteLine("Saving oscilloscope setup to " + _
```

```

        "c:\scope\config\setup.dat")
If File.Exists("c:\scope\config\setup.dat") Then
    File.Delete("c:\scope\config\setup.dat")
End If

' Query and read setup string.
ResultsArray = myScope.DoQueryIEEEBlock(":SYSTem:SETup?")
nBytes = ResultsArray.Length
Console.WriteLine("Read oscilloscope setup ({0} bytes).", nBytes)

' Write setup string to file.
File.WriteAllBytes("c:\scope\config\setup.dat", ResultsArray)
Console.WriteLine("Wrote setup string ({0} bytes) to file.", _
    nBytes)

' RESTORE_SYSTEM_SETUP - Uploads a previously saved setup
' string to the oscilloscope.
Dim dataArray As Byte()

' Read setup string from file.
dataArray = File.ReadAllBytes("c:\scope\config\setup.dat")
Console.WriteLine("Read setup string ({0} bytes) from file.", _
    dataArray.Length)

' Restore setup string.
myScope.DoCommandIEEEBlock(":SYSTem:SETup", dataArray)
Console.WriteLine("Restored setup string.")

' IMAGE_TRANSFER - In this example, we query for the screen
' data with the ":DISPLAY:DATA?" query. The .png format
' data is saved to a file in the local file system.
Console.WriteLine("Transferring screen image to " + _
    "c:\scope\data\screen.png")
If File.Exists("c:\scope\data\screen.png") Then
    File.Delete("c:\scope\data\screen.png")
End If

' Increase I/O timeout to fifteen seconds.
myScope.SetTimeoutSeconds(15)

' Get the screen data in PNG format.
ResultsArray = _
    myScope.DoQueryIEEEBlock(":DISPlay:DATA? PNG, SCReen, COLor")
nBytes = ResultsArray.Length
Console.WriteLine("Read screen image ({0} bytes).", nBytes)

' Store the screen data in a file.
File.WriteAllBytes("c:\scope\data\screen.png", ResultsArray)
Console.WriteLine("Wrote screen image ({0} bytes) to file.", _
    nBytes)

' Return I/O timeout to five seconds.
myScope.SetTimeoutSeconds(5)

' MEASURE - The commands in the MEASURE subsystem are used to
' make measurements on displayed waveforms.

```

```

' Set source to measure.
myScope.DoCommand(":MEASure:SOURce CHANnel1")

' Query for frequency.
Dim fResults As Double
fResults = myScope.DoQueryValue(":MEASure:FREQuency?")
Console.WriteLine("The frequency is: {0:F4} kHz", _
    fResults / 1000)

' Query for peak to peak voltage.
fResults = myScope.DoQueryValue(":MEASure:VPP?")
Console.WriteLine("The peak to peak voltage is: {0:F2} V", _
    fResults)

' WAVEFORM_DATA - Get waveform data from oscilloscope. To
' obtain waveform data, you must specify the WAVEFORM
' parameters for the waveform data prior to sending the
' ":WAVEFORM:DATA?" query.
'
' Once these parameters have been sent, the
' ":WAVEFORM:PREAmBLE?" query provides information concerning
' the vertical and horizontal scaling of the waveform data.
'
' With the preamble information you can then use the
' ":WAVEFORM:DATA?" query and read the data block in the
' correct format.

' WAVE_FORMAT - Sets the data transmission mode for waveform
' data output. This command controls how the data is
' formatted when sent from the oscilloscope and can be set
' to WORD or BYTE format.

' Set waveform format to BYTE.
myScope.DoCommand(":WAVEform:FORMat BYTE")

' WAVE_POINTS - Sets the number of points to be transferred.
' The number of time points available is returned by the
' "ACQUIRE:POINTS?" query. This can be set to any binary
' fraction of the total time points available.
myScope.DoCommand(":WAVEform:POINTs 1000")

' GET_PREAMBLE - The preamble contains all of the current
' WAVEFORM settings returned in the form <preamble block><NL>
' where the <preamble block> is:
'   FORMAT      : int16 - 0 = BYTE, 1 = WORD, 2 = ASCII.
'   TYPE        : int16 - 0 = NORMAL, 1 = PEAK DETECT,
'                 2 = AVERAGE.
'   POINTS      : int32 - number of data points transferred.
'   COUNT       : int32 - 1 and is always 1.
'   XINCREMENT  : float64 - time difference between data
'                       points.
'   XORIGIN     : float64 - always the first data point in
'                       memory.
'   XREFERENCE  : int32 - specifies the data point associated
'                       with the x-origin.
'   YINCREMENT  : float32 - voltage difference between data
'                       points.

```

12 Programming Examples

```
'      YORIGIN      : float32 - value of the voltage at center
'
'                      screen.
'      YREFERENCE   : int32 - data point where y-origin occurs.

Console.WriteLine("Reading preamble.")
Dim fResultsArray As Double()
fResultsArray = myScope.DoQueryValues(":WAVEform:PREamble?")

Dim fFormat As Double = fResultsArray(0)
Console.WriteLine("Preamble FORMat: {0:e}", fFormat)

Dim fType As Double = fResultsArray(1)
Console.WriteLine("Preamble TYPE: {0:e}", fType)

Dim fPoints As Double = fResultsArray(2)
Console.WriteLine("Preamble POINTs: {0:e}", fPoints)

Dim fCount As Double = fResultsArray(3)
Console.WriteLine("Preamble COUNT: {0:e}", fCount)

Dim fXincrement As Double = fResultsArray(4)
Console.WriteLine("Preamble XINCrement: {0:e}", fXincrement)

Dim fXorigin As Double = fResultsArray(5)
Console.WriteLine("Preamble XORigin: {0:e}", fXorigin)

Dim fXreference As Double = fResultsArray(6)
Console.WriteLine("Preamble XREFerence: {0:e}", fXreference)

Dim fYincrement As Double = fResultsArray(7)
Console.WriteLine("Preamble YINCrement: {0:e}", fYincrement)

Dim fYorigin As Double = fResultsArray(8)
Console.WriteLine("Preamble YORigin: {0:e}", fYorigin)

Dim fYreference As Double = fResultsArray(9)
Console.WriteLine("Preamble YREFerence: {0:e}", fYreference)

' QUERY_WAVE_DATA - Outputs waveform records to the controller
' over the interface that is stored in a buffer previously
' specified with the ":WAVEform:SOURce" command.

' READ_WAVE_DATA - The wave data consists of two parts: the
' header, and the actual waveform data followed by a
' New Line (NL) character. The query data has the following
' format:
'
'      <header><waveform data block><NL>
'
' Where:
'
'      <header> = #800002048      (this is an example header)
'
' The "#8" may be stripped off of the header and the remaining
' numbers are the size, in bytes, of the waveform data block.
' The size can vary depending on the number of points acquired
' for the waveform which can be set using the
```



```

' ":WAVEFORM:POINTS" command. You may then read that number
' of bytes from the oscilloscope; then, read the following NL
' character to terminate the query.

' Read waveform data.
ResultsArray = myScope.DoQueryIEEEBlock(":WAVEform:DATA?")
nBytes = ResultsArray.Length
Console.WriteLine("Read waveform data ({0} bytes).", nBytes)

' Make some calculations from the preamble data.
Dim fVdiv As Double = 32 * fYincrement
Dim fOffset As Double = fYorigin
Dim fSdiv As Double = fPoints * fXincrement / 10
Dim fDelay As Double = (fPoints / 2) * fXincrement + fXorigin

' Print them out...
Console.WriteLine("Scope Settings for Channel 1:")
Console.WriteLine("Volts per Division = {0:f}", fVdiv)
Console.WriteLine("Offset = {0:f}", fOffset)
Console.WriteLine("Seconds per Division = {0:e}", fSdiv)
Console.WriteLine("Delay = {0:e}", fDelay)

' Print the waveform voltage at selected points:
Dim i As Integer = 0
While i < nBytes
    Console.WriteLine("Data point {0:d} = {1:f6} Volts at " + _
        "{2:f10} Seconds", i, _
        (CSng(ResultsArray(i)) - fYreference) * fYincrement + _
        fYorigin, (CSng(i) - fXreference) * fXincrement + fXorigin)
    i = i + (nBytes / 20)
End While

' SAVE_WAVE_DATA - saves the waveform data to a CSV format
' file named "waveform.csv".
If File.Exists("c:\scope\data\waveform.csv") Then
    File.Delete("c:\scope\data\waveform.csv")
End If

Dim writer As StreamWriter = _
    File.CreateText("c:\scope\data\waveform.csv")
For index As Integer = 0 To nBytes - 1
    writer.WriteLine("{0:E}, {1:f6}", _
        (CSng(index) - fXreference) * fXincrement + fXorigin, _
        (CSng(ResultsArray(index)) - fYreference) * fYincrement _
        + fYorigin)
Next
writer.Close()
Console.WriteLine("Waveform data ({0} points) written to " + _
    "c:\scope\data\waveform.csv.", nBytes)
End Sub
End Class

Class VisaComInstrument
    Private m_ResourceManager As ResourceManagerClass
    Private m_IOException As FormattedIO488Class
    Private m_strVisaAddress As String

```

12 Programming Examples

```
' Constructor.
Public Sub New(ByVal strVisaAddress As String)
    ' Save VISA address in member variable.
    m_strVisaAddress = strVisaAddress

    ' Open the default VISA COM IO object.
    OpenIo()

    ' Clear the interface.
    m_IoObject.IO.Clear()
End Sub

Public Sub DoCommand(ByVal strCommand As String)
    ' Send the command.
    m_IoObject.WriteString(strCommand, True)

    ' Check for instrument errors.
    CheckForInstrumentErrors(strCommand)
End Sub

Public Function DoQueryString(ByVal strQuery As String) As String
    ' Send the query.
    m_IoObject.WriteString(strQuery, True)

    ' Get the result string.
    Dim strResults As String
    strResults = m_IoObject.ReadString()

    ' Check for instrument errors.
    CheckForInstrumentErrors(strQuery)

    ' Return results string.
    Return strResults
End Function

Public Function DoQueryValue(ByVal strQuery As String) As Double
    ' Send the query.
    m_IoObject.WriteString(strQuery, True)

    ' Get the result number.
    Dim fResult As Double
    fResult = _
        CDb1(m_IoObject.ReadNumber(IEEEASCIIType.ASCIIType_R8, True))

    ' Check for instrument errors.
    CheckForInstrumentErrors(strQuery)

    ' Return result number.
    Return fResult
End Function

Public Function DoQueryValues(ByVal strQuery As String) As Double()
    ' Send the query.
    m_IoObject.WriteString(strQuery, True)

    ' Get the result numbers.
    Dim fResultsArray As Double()
```

```

fResultsArray = _
    m_IoObject.ReadList(IEEEASCIIType.ASCIIType_R8, ",;")

' Check for instrument errors.
CheckForInstrumentErrors(strQuery)

' Return result numbers.
Return fResultsArray
End Function

Public _
    Function DoQueryIEEEBlock(ByVal strQuery As String) As Byte()
' Send the query.
m_IoObject.WriteString(strQuery, True)

' Get the results array.
Dim ResultsArray As Byte()
ResultsArray = _
    m_IoObject.ReadIEEEBlock(IEEEBinaryType.BinaryType_UI1, _
        False, True)

' Check for instrument errors.
CheckForInstrumentErrors(strQuery)

' Return results array.
Return ResultsArray
End Function

Public _
    Sub DoCommandIEEEBlock(ByVal strCommand As String, _
        ByVal dataArray As Byte())
' Send the command.
m_IoObject.WriteIEEEBlock(strCommand, dataArray, True)

' Check for instrument errors.
CheckForInstrumentErrors(strCommand)
End Sub

Private Sub CheckForInstrumentErrors(ByVal strCommand As String)
Dim strInstrumentError As String
Dim bFirstError As Boolean = True

' Repeat until all errors are displayed.
Do
' Send the ":SYSTEM:ERROR?" query, and get the result string.
m_IoObject.WriteString(":SYSTEM:ERROR?", True)
strInstrumentError = m_IoObject.ReadString()

' If there is an error, print it.
If strInstrumentError.ToString() <> "+0,"No error"" " _
    & Chr(10) & "" Then
    If bFirstError Then
        ' Print the command that caused the error.
        Console.WriteLine("ERROR(s) for command '{0}': ", _
            strCommand)
        bFirstError = False
    End If
End If

```

12 Programming Examples

```
        Console.WriteLine(strInstrumentError)
    End If
    Loop While strInstrumentError.ToString() <> "+0,""No error"" _
        & Chr(10) & ""
End Sub

Private Sub OpenIo()
    m_ResourceManager = New ResourceManagerClass()
    m_IoObject = New FormattedIO488Class()

    ' Open the default VISA COM IO object.
    Try
        m_IoObject.IO = _
            DirectCast(m_ResourceManager.Open(m_strVisaAddress, _
                AccessMode.NO_LOCK, 0, ""), IMessage)
    Catch e As Exception
        Console.WriteLine("An error occurred: {0}", e.Message)
    End Try
End Sub

Public Sub SetTimeoutSeconds(ByVal nSeconds As Integer)
    m_IoObject.IO.Timeout = nSeconds * 1000
End Sub

Public Sub Close()
    Try
        m_IoObject.IO.Close()
    Catch
    End Try

    Try
        Marshal.ReleaseComObject(m_IoObject)
    Catch
    End Try

    Try
        Marshal.ReleaseComObject(m_ResourceManager)
    Catch
    End Try
End Sub
End Class
End Namespace
```

Index

Symbols

+9.9E+37, infinity representation, 761
+9.9E+37, measurement error, 300

Numerics

0 (zero) values in waveform data, 583
1 (one) values in waveform data, 583
10 MHz REF BNC, enabling/disabling, 447
10 MHz reference signal, 181
82350A GPIB interface, 4

A

AC coupling, trigger edge, 487
AC input coupling for specified channel, 213
accumulate activity, 134
acknowledge, 691
ACQuire commands, 173
acquire data, 142, 188
acquire mode on autoscale, 138
acquire reset conditions, 120
acquire sample rate, 187
ACQuire subsystem, 45
acquired data points, 180
acquisition anti-alias control, 175
acquisition count, 177
acquisition mode, 173, 179, 600
acquisition type, 173, 188
active edges, 134
active printer, 275
activity logic levels, 134
activity on digital channels, 134
add function, 595
add math function, 264
add math function as g(t) source, 260
ADDRes commands, 610
address field size, IIC serial decode, 423
address, IIC trigger pattern, 514
Addresses softkey, 32
AER (Arm Event Register), 135, 157, 159, 722
Agilent Connection Expert, 33
Agilent Interactive IO application, 37
Agilent IO Control icon, 33
Agilent IO Libraries Suite, 4, 29, 42, 44
Agilent IO Libraries Suite, installing, 30
ALB waveform data format, 403
ALL segments waveform save option, 405
alphabetical list of commands, 609
AMASk commands, 610
amplitude, vertical, 334
analog channel coupling, 213

analog channel display, 214
analog channel impedance, 215
analog channel input, 650
analog channel inversion, 216
analog channel labels, 217, 241
analog channel offset, 218
analog channel protection lock, 438
analog channel range, 224
analog channel scale, 225
analog channel source for glitch, 512
analog channel units, 226
analog channels only oscilloscopes, 4
analog probe attenuation, 219
analog probe sensing, 651
analog probe skew, 221, 649
analyzing captured data, 41
angle brackets, 100
annotate channels, 217
anti-alias control, 175
AREA commands, 610
area for hardcopy print, 274
area for saved image, 394
Arm Event Register (AER), 135, 157, 159, 722
arrange waveforms, 653
ASCII format, 585
ASCII format for data transfer, 575
ASCII string, quoted, 100
ASCIixy waveform data format, 403
assign channel names, 217
attenuation factor (external trigger) probe, 249
attenuation for oscilloscope probe, 219
AUT option for probe sense, 651, 656
auto trigger sweep mode, 454
automask create, 351
automask source, 352
automask units, 353
automatic measurements constants, 219
automatic probe type detection, 651, 656
Automation-Ready CD, 30
autoscale, 136
autoscale acquire mode, 138
autoscale channels, 139
AUToscale command, 44
AVERage commands, 610
average value measurement, 335
averaging acquisition type, 174, 575
averaging, synchronizing with, 736

B

bandwidth filter limits, 247
bandwidth filter limits to 20 MHz, 212
BASE commands, 610

base value measurement, 336
base, UART trigger, 555
basic instrument functions, 107
Bat On bit, 146, 148
baud rate, 472, 525, 556
BAUDrate commands, 611
begin acquisition, 142, 166, 168
BHARris window for minimal spectral leakage, 271
binary block data, 100, 439, 583
BINary waveform data format, 403
bind levels for masks, 372
bit order, 557
bit selection command, bus, 192
bit weights, 112
bitmap display, 238
bits in Service Request Enable Register, 125
bits in Standard Event Status Enable Register, 111
bits in Status Byte Register, 127
bits selection command, bus, 193
blank, 140
block data, 100, 115, 238, 439
block response data, 48
blocking synchronization, 731
blocking wait, 730
BMP (bitmap) hardcopy format, 662
braces, 99
built-in measurements, 41
burst, minimum time before next, 484
bus bit selection command, 192
bus bits selection commands, 193
bus clear command, 195
BUS commands, 190
bus commands, 191
bus display, 196
bus label command, 197
bus mask command, 198
BUSDoctor commands, 611
button disable, 437
BWLimit commands, 611
byte format for data transfer, 575, 585
BYTeorder, 581

C

C#, VISA COM example, 838
C#, VISA example, 801
C, SICL library example, 764
C, VISA library example, 782
CAL PROTECT switch, 199, 206
calculating preshoot of waveform, 317
calculating the waveform overshoot, 313

Index

- calibrate, [201, 202, 206, 208](#)
- CALibrate commands, [199](#)
- calibrate date, [201](#)
- calibrate introduction, [199](#)
- calibrate label, [202](#)
- calibrate output, [203](#)
- calibrate start, [204](#)
- calibrate status, [205](#)
- calibrate switch, [206](#)
- calibrate temperature, [207](#)
- calibrate time, [208](#)
- CAN, [467](#)
- CAN acknowledge, [471, 691](#)
- CAN baud rate, [472](#)
- CAN commands, [611](#)
- CAN frame counters, reset, [415](#)
- CAN id pattern, [469](#)
- CAN signal definition, [692](#)
- CAN source, [473](#)
- CAN trigger, [468, 474](#)
- CAN trigger commands, [465](#)
- CAN trigger pattern id mode, [470](#)
- CAN triggering, [454](#)
- capture data, [142](#)
- capturing data, [40](#)
- CDISplay, [141](#)
- center frequency set, [257, 258](#)
- center of screen, [608](#)
- center reference, [448](#)
- center screen, vertical value at, [263, 266](#)
- channel, [172, 217, 646, 648](#)
- CHANnel commands, [209, 210](#)
- channel coupling, [213](#)
- channel display, [214](#)
- channel input impedance, [215](#)
- channel inversion, [216](#)
- channel label, [217, 647](#)
- channel labels, [240, 241](#)
- channel numbers, [653](#)
- channel overload, [223](#)
- channel probe ID, [250](#)
- channel protection, [223](#)
- channel reset conditions, [120](#)
- channel selected to produce trigger, [512, 551](#)
- channel signal type, [222](#)
- channel skew for oscilloscope probe, [221, 649](#)
- channel status, [169, 653](#)
- channel threshold, [648](#)
- channel vernier, [227](#)
- channel, stop displaying, [140](#)
- channels to autoscale, [139](#)
- channels, how autoscale affects, [136](#)
- characters to display, [435](#)
- classes of input signals, [271](#)
- classifications, command, [740](#)
- clear, [237](#)
- clear bus command, [195](#)
- CLEar commands, [613](#)
- clear cumulative edge variables, [646](#)
- clear display, [141](#)
- clear markers, [302, 667](#)
- clear measurement, [302, 667](#)
- clear message queue, [109](#)
- Clear method, [43](#)
- clear screen, [654](#)
- clear status, [109](#)
- clear waveform area, [235](#)
- clipped high waveform data value, [583](#)
- clipped low waveform data value, [583](#)
- clock, [517, 539, 540, 544](#)
- CLOCK commands, [613](#)
- CLS (Clear Status), [109](#)
- CME (Command Error) status bit, [111, 113](#)
- CMOS threshold voltage for digital channels, [234, 648](#)
- CMOS trigger threshold voltage, [694](#)
- code, *RST, [122](#)
- code, :ACQUIRE:COMPLETE, [176](#)
- code, :ACQUIRE:SEGMENTed, [184](#)
- code, :ACQUIRE:TYPE, [189](#)
- code, :AUToscale, [137](#)
- code, :CHANnel:LABel, [217](#)
- code, :CHANnel:PROBe, [219](#)
- code, :CHANnel:RANGe, [224](#)
- code, :DIGitize, [142](#)
- code, :DISPlay:DATA, [239](#)
- code, :DISPlay:LABel, [240](#)
- code, :DISPlay:ORDeR, [653](#)
- code, :MEASure:PERiod, [326](#)
- code, :MEASure:RESults, [319](#)
- code, :MEASure:TEDGe, [331](#)
- code, :MTEST, [348](#)
- code, :POD:THReshold, [382](#)
- code, :RUN/:STOP, [166](#)
- code, :SYSTem:SETup, [439](#)
- code, :TIMEbase:DElay, [690](#)
- code, :TIMEbase:MODE, [444](#)
- code, :TIMEbase:RANGe, [446](#)
- code, :TIMEbase:REFerence, [448](#)
- code, :TRIGger:MODE, [460](#)
- code, :TRIGger:SLOPe, [490](#)
- code, :TRIGger:SOURce, [491](#)
- code, :VIEW and :BLANk, [172](#)
- code, :WAVEform, [596](#)
- code, :WAVEform:DATA, [583](#)
- code, :WAVEform:POINts, [587](#)
- code, :WAVEform:PREAmble, [591](#)
- code, :WAVEform:SEGMENTed, [184](#)
- code, SICL library example in C, [764](#)
- code, SICL library example in Visual Basic, [773](#)
- code, VISA COM library example in C#, [838](#)
- code, VISA COM library example in Visual Basic, [828](#)
- code, VISA COM library example in Visual Basic .NET, [849](#)
- code, VISA library example in C, [782](#)
- code, VISA library example in C#, [801](#)
- code, VISA library example in Visual Basic, [791](#)
- code, VISA library example in Visual Basic .NET, [815](#)
- colon, root commands prefixed by, [133](#)
- color palette for hardcopy, [280](#)
- color palette for image, [398](#)
- Comma Separated Values (CSV) hardcopy format, [662](#)
- Comma Separated Values (CSV) waveform data format, [403](#)
- command classifications, [740](#)
- command errors detected in Standard Event Status, [113](#)
- command header, [742](#)
- command headers, common, [744](#)
- command headers, compound, [743](#)
- command headers, simple, [743](#)
- command strings, valid, [741](#)
- command tree, [745](#)
- commands by subsystem, [103](#)
- commands in alphabetical order, [609](#)
- commands quick reference, [53](#)
- commands sent over interface, [107](#)
- commands, more about, [739](#)
- commands, obsolete and discontinued, [641](#)
- common (*) commands, [104, 105, 107](#)
- common command headers, [744](#)
- completion criteria for an acquisition, [176, 177](#)
- compound command headers, [743](#)
- compound header, [759](#)
- computer control examples, [763](#)
- conditions for external trigger, [245](#)
- conditions, reset, [120](#)
- configurations, oscilloscope, [115, 119, 123, 439](#)
- Configure softkey, [32](#)
- connect oscilloscope, [31](#)
- connect sampled data points, [652](#)
- constants for making automatic measurements, [219](#)
- constants for scaling display factors, [219](#)
- constants for setting trigger levels, [219](#)
- Control softkey, [31, 32](#)
- controller initialization, [40](#)
- copy display, [165](#)
- core commands, [740](#)
- count, [531, 582](#)
- COUNT commands, [613](#)
- count values, [177](#)
- count, Nth edge of burst, [483](#)
- counter, [303](#)
- coupling, [487](#)
- COUPLing commands, [614](#)
- coupling for channels, [213](#)
- create automask, [351](#)
- CSV (Comma Separated Values) hardcopy format, [662](#)
- CSV (Comma Separated Values) waveform data format, [403](#)
- cumulative edge activity, [646](#)
- current logic levels on digital channels, [134](#)
- current oscilloscope configuration, [115, 119, 123, 439](#)
- current probe, [226, 254](#)
- CURRent segment waveform save option, [405](#)
- cursor mode, [285](#)
- cursor position, [286, 288, 290, 291, 293](#)
- cursor readout, [668, 672, 673](#)

cursor reset conditions, 120
 cursor source, 287, 289
 cursor time, 668, 672, 673
 cursors track measurements, 324
 cursors, how autoscale affects, 136
 cursors, X1, X2, Y1, Y2, 284
 cycle base, FLEXray time trigger, 499
 cycle count base, FLEXray frame trigger, 495
 cycle count repetition, FLEXray frame trigger, 496
 cycle measured, 309
 cycle repetition, FLEXray time trigger, 500
 cycle time, 315

D

D- source, 569
 D+ source, 570
 data, 467, 515, 518, 542, 545, 583
 data 2, 516
 DATA commands, 614
 data conversion, 575
 data displayed, 238
 data format for transfer, 575
 data output order, 581
 data pattern length, 468
 data pattern width, 543
 data point index, 605
 data points, 180
 data required to fill time buckets, 176
 data structures, status reporting, 708
 data transfer, 238
 data, erasing, 141
 data, saving and recalling, 235
 DATE commands, 614
 date, calibration, 201
 date, system, 434
 dB versus frequency, 257
 DC coupling for edge trigger, 487
 DC input coupling for specified channel, 213
 dc RMS measured on waveform, 341
 DDE (Device Dependent Error) status bit, 111, 113
 decision chart, status reporting, 728
 default conditions, 120
 define channel labels, 217
 define glitch trigger, 510
 define logic thresholds, 648
 define measurement, 305
 define measurement source, 325
 define trigger, 462, 477, 478, 479, 481, 511, 532
 defined as, 99
 definite-length block query response, 48
 definite-length block response data, 100
 DEFinition commands, 614
 DELay commands, 614
 delay measured to calculate phase, 316
 delay measurement, 305
 delay measurements, 330
 delay parameters for measurement, 307
 delay, how autoscale affects, 136
 delayed time base, 444
 delayed time base mode, how autoscale affects, 136
 delayed window horizontal scale, 453
 delete mask, 361
 delta time, 668
 delta voltage measurement, 677
 delta X cursor, 284
 delta Y cursor, 284
 DeskJet, 660
 destination, 243
 detecting probe types, 651, 656
 device for hardcopy, 660
 device-defined error queue clear, 109
 differential signal type, 222, 251
 differentiate math function, 178, 257, 264, 595
 DIFFerentiate source for function, 269, 657
 digital channel commands, 228, 230, 231, 232, 234
 digital channel data, 575
 digital channel labels, 241
 digital channel order, 653
 digital channel source for glitch trigger, 512
 digital channels, 4
 digital channels, activity and logic levels on, 134
 digital channels, groups of, 379, 380, 382
 DIGital commands, 228
 digital pod, stop displaying, 140
 digital reset conditions, 120
 digitize channels, 142
 DIGitize command, 41, 45
 digits, 100
 disable anti-alias mode, 178
 disable front panel, 437
 disable function, 658
 disabling calibration, 206
 disabling channel display, 214
 disabling status register bits, 110, 124
 discontinued and obsolete commands, 641
 display channel labels, 240
 display clear, 237
 DISPLAY commands, 235, 615
 display commands introduction, 235
 display connect, 652
 display data, 238
 display date, 434
 display factors scaling, 219
 display for channels, 214
 display frequency span, 270
 display measurements, 300, 324
 display order, 653
 display persistence, 242
 display reference, 445, 448
 display reset conditions, 120
 display serial number, 167
 display source, 243
 display vectors, 244
 display wave position, 653
 display, clearing, 141
 display, oscilloscope, 230, 242, 243, 244, 259, 380, 435

display, serial decode bus, 418
 displaying a baseline, 464
 displaying unsynchronized signal, 464
 DNS IP, 31
 domain, 31
 Domain softkey, 32
 driver, printer, 665
 DSO models, 4
 duplicate mnemonics, 758
 duration, 477, 478, 481
 duration for glitch trigger, 506, 507, 511
 duration pattern, 479
 duration qualifier, trigger, 477, 478, 480
 DURation trigger commands, 476
 duration triggering, 454
 duty cycle measurement, 41, 300, 309

E

EBURst trigger commands, 482
 ECL channel threshold, 648
 ECL threshold voltage for digital channels, 234
 ECL trigger threshold voltage, 694
 edge, 532
 edge activity, 646
 edge counter, 531
 edge counter, Nth edge of burst, 483
 edge coupling, 487
 edge define, 462, 532
 edge fall time, 310
 edge parameter for delay measurement, 307
 edge preshoot measured, 317
 edge rise time, 322
 edge slope, 490
 edge source, 491
 EDGE trigger commands, 486
 edge triggering, 454
 edges (activity) on digital channels, 134
 edges in measurement, 305
 elapsed time in mask test, 358
 ellipsis, 100
 enable channel labels, 240
 enabling calibration, 206
 enabling channel display, 214
 enabling status register bits, 110, 124
 end of string (EOS) terminator, 742
 end of text (EOT) terminator, 742
 end or identify (EOI), 742
 enter pattern, 462
 EOI (end or identify), 742
 EOS (end of string) terminator, 742
 EOT (end of text) terminator, 742
 Epson, 660
 equivalent-time acquisition mode, 174, 179
 erase data, 141, 237
 erase functions, 141
 erase measurements, 667
 erase screen, 654
 ERRor commands, 615
 error frame count (CAN), 413
 error frame count (UART), 428
 error messages, 436, 697

error number, 436
 error queue, 436, 719
 error, measurement, 300
 ESB (Event Status Bit), 125, 127
 ESE (Standard Event Status Enable Register), 110, 718
 ESR (Standard Event Status Register), 112, 717
 EVENT commands, 616
 event status conditions occurred, 127
 Event Status Enable Register (ESE), 110, 718
 Event Status Register (ESR), 112, 171, 717
 example code, *RST, 122
 example code, :ACQUIRE:COMPLETE, 176
 example code, :ACQUIRE:SEGMENTED, 184
 example code, :ACQUIRE:TYPE, 189
 example code, :AUTOSCALE, 137
 example code, :CHANNEL:LABEL, 217
 example code, :CHANNEL:PROBE, 219
 example code, :CHANNEL:RANGE, 224
 example code, :DIGITIZE, 142
 example code, :DISPLAY:DATA, 239
 example code, :DISPLAY:LABEL, 240
 example code, :DISPLAY:ORDER, 653
 example code, :MEASURE:PERIOD, 326
 example code, :MEASURE:RESULTS, 319
 example code, :MEASURE:TEDGE, 331
 example code, :MTEST, 348
 example code, :POD:THRESHOLD, 382
 example code, :RUN:/STOP, 166
 example code, :SYSTEM:SETUP, 439
 example code, :TIMEBASE:DELAY, 690
 example code, :TIMEBASE:MODE, 444
 example code, :TIMEBASE:RANGE, 446
 example code, :TIMEBASE:REFERENCE, 448
 example code, :TRIGGER:MODE, 460
 example code, :TRIGGER:SLOPE, 490
 example code, :TRIGGER:SOURCE, 491
 example code, :VIEW and :BLANK, 172
 example code, :WAVEFORM, 596
 example code, :WAVEFORM:DATA, 583
 example code, :WAVEFORM:POINTS, 587
 example code, :WAVEFORM:PREAMBLE, 591
 example code, :WAVEFORM:SEGMENTED, 184
 example programs, 4, 763
 EXE (Execution Error) status bit, 111, 113
 execution error detected in Standard Event Status, 113
 exponential notation, 99
 external glitch trigger source, 512
 external range, 253
 external trigger, 245, 248, 249, 491, 655
 EXTERNAL trigger commands, 245
 external trigger input impedance, 248, 655
 EXTERNAL trigger level, 488
 external trigger overload, 252
 external trigger probe attenuation factor, 249
 external trigger probe ID, 250
 external trigger probe sensing, 656
 external trigger protection, 252
 external trigger signal type, 251
 EXTERNAL trigger source, 491
 external trigger units, 254

F

FACTion commands, 616
 FACTors commands, 616
 fail (mask test) output, 364
 failed waveforms in mask test, 356
 failure, self test, 129
 fall time measurement, 300, 310
 falling edge, 462, 532
 Fast Fourier Transform (FFT) functions, 257, 258, 269, 270, 271, 657
 FF values in waveform data, 583
 FFT (Fast Fourier Transform) functions, 257, 258, 269, 270, 271, 657
 FFT (Fast Fourier Transform) operation, 264, 595
 FFT math function, 178
 fifty ohm impedance, disable setting, 438
 FILENAME commands, 616
 filename for hardcopy, 661
 filename for recall, 385
 filename for save, 392
 filter for frequency reject, 489
 filter for high frequency reject, 458
 filter for noise reject, 461
 filter used to limit bandwidth, 212, 247
 filters to Fast Fourier Transforms, 271
 find stage in sequence trigger, 533
 fine horizontal adjustment (vernier), 450
 fine vertical adjustment (vernier), 227
 finish pending device operations, 116
 first point displayed, 605
 FLATtop window for amplitude measurements, 271
 FLEXray commands, 616
 FlexRay frame counters, reset, 420
 FLEXray trigger, 503
 FLEXray trigger commands, 492
 FlexRay triggering, 454
 format, 585, 590
 FORMAT commands, 617
 format for block data, 115
 format for generic video, 548, 552
 format for hardcopy, 659, 662
 format for image, 396
 format for waveform data, 403
 FormattedIO488 object, 43
 formfeed for hardcopy, 273, 277
 frame, 546
 FRAME commands, 617
 frame counters (CAN), error, 413
 frame counters (CAN), overload, 414
 frame counters (CAN), reset, 415
 frame counters (CAN), total, 416
 frame counters (FlexRay), null, 419, 421
 frame counters (FlexRay), reset, 420
 frame counters (FlexRay), total, 422
 frame counters (UART), error, 428
 frame counters (UART), reset, 429
 frame counters (UART), Rx frames, 430
 frame counters (UART), Tx frames, 431
 frame ID, FLEXray frame trigger, 497

frame type, FLEXray frame trigger, 498
 framing, 541
 FRAMing commands, 617
 frequency measurement, 41, 300, 311
 frequency resolution, 271
 frequency span of display, 270
 frequency versus dB, 257
 front panel mode, 464
 front panel Single key, 168
 front panel Stop key, 170
 front-panel lock, 437
 full-scale horizontal time, 446, 452
 full-scale vertical axis defined, 265
 function, 172, 258, 259, 263, 264, 265, 266, 267, 269, 270, 271, 657, 658
 FUNCTION commands, 255
 function memory, 169
 function turned on or off, 658
 functions, 595
 functions, erasing, 141

G

g(t) source, first input channel, 261
 g(t) source, math operation, 260
 g(t) source, second input channel, 262
 gateway IP, 31
 general trigger commands, 457
 GENERIC, 548, 552
 generic video format, 548, 552
 glitch duration, 511
 glitch qualifier, 510
 glitch source, 512
 GLITCH trigger commands, 504
 glitch trigger duration, 506
 glitch trigger polarity, 509
 glitch trigger source, 506
 GOFT commands, 618
 graphics, 238
 graticule area for hardcopy print, 274
 graticule area for saved image, 394
 graticule colors, invert for hardcopy, 278, 664
 graticule colors, invert for image, 397
 graticule data, 238
 grayscale palette for hardcopy, 280
 grayscale palette for image, 398
 grayscale on hardcopy, 663
 greater than qualifier, 510
 greater than time, 477, 481, 506, 511
 GREATERthan commands, 618
 groups of digital channels, 379, 380, 382, 648

H

HANNing window for frequency resolution, 271
 hardcopy, 165, 273
 HARDcopy commands, 272
 hardcopy device, 660
 hardcopy factors, 276, 395
 hardcopy filename, 661

hardcopy format, [659, 662](#)
 hardcopy formfeed, [277](#)
 hardcopy grayscale, [663](#)
 hardcopy invert graticule colors, [278, 664](#)
 hardcopy layout, [279](#)
 hardcopy palette, [280](#)
 hardcopy print, area, [274](#)
 hardcopy printer driver, [665](#)
 hardware event condition register, [146](#)
 Hardware Event Condition Register
 (:HWERegister:CONDition), [146](#)
 Hardware Event Condition Register
 (:OPERegister:CONDition), [725](#)
 Hardware Event Enable Register
 (HWEenable), [144](#)
 hardware event event register, [148](#)
 Hardware Event Event Register
 (:HWERegister[:EVENT]), [148, 724](#)
 header, [742](#)
 high-frequency reject filter, [458, 489](#)
 high-resolution acquisition type, [174](#)
 hold until operation complete, [116](#)
 holdoff time, [459](#)
 holes in waveform data, [583](#)
 horizontal adjustment, fine (vernier), [450](#)
 horizontal position, [451](#)
 horizontal scale, [449, 453](#)
 horizontal scaling, [590](#)
 horizontal time, [446, 452, 668](#)
 hostname, [31](#)
 HWEenable (Hardware Event Enable
 Register), [144](#)
 HWERegister:CONDition (Hardware Event
 Condition Register), [146, 725](#)
 HWERegister[:EVENT] (Hardware Event Event
 Register), [148, 724](#)

I

I/O softkey, [31, 32](#)
 I1080L50HZ, [548, 552](#)
 I1080L60HZ, [548, 552](#)
 ID commands, [619](#)
 id mode, [470](#)
 identification number, [114](#)
 identification of options, [117](#)
 identifier, [469](#)
 identifier, LIN, [523](#)
 idle, [484](#)
 IDLE commands, [619](#)
 idle until operation complete, [116](#)
 IDN (Identification Number), [114](#)
 IEEE 488.2 standard, [107](#)
 IGCOLORS commands, [619](#)
 IIC address, [514](#)
 IIC clock, [517](#)
 IIC commands, [619](#)
 IIC data, [515, 518](#)
 IIC data 2, [516](#)
 IIC serial decode address field size, [423](#)
 IIC trigger commands, [513](#)
 IIC trigger qualifier, [519](#)
 IIC trigger type, [520](#)
 IIC triggering, [454](#)
 IMAGE commands, [619](#)
 image format, [396](#)
 image invert graticule colors, [397](#)
 image memory, [169, 243](#)
 image palette, [398](#)
 image, recall, [386](#)
 image, save, [393](#)
 image, save with inksaver, [397](#)
 impedance, [215](#)
 IMPedance commands, [619](#)
 impedance for external trigger input, [248, 655](#)
 infinity representation, [761](#)
 initialization, [40, 43](#)
 initialize, [120](#)
 initialize label list, [241](#)
 initiate acquisition, [142](#)
 inksaver, save image with, [397](#)
 input, [248, 655](#)
 input coupling for channels, [213](#)
 input impedance for channels, [215, 650](#)
 input impedance for external trigger, [248, 655](#)
 input inversion for specified channel, [216](#)
 insert label, [217](#)
 installed options identified, [117](#)
 instruction header, [742](#)
 instrument number, [114](#)
 instrument options identified, [117](#)
 instrument requests service, [127](#)
 instrument serial number, [167](#)
 instrument settings, [273](#)
 instrument status, [50](#)
 instrument type, [114](#)
 integrate math function, [257, 264, 595](#)
 INTegrate source for function, [269, 657](#)
 INTERN files, [243](#)
 internal low-pass filter, [212, 247](#)
 introduction to :ACQUIRE commands, [173](#)
 introduction to :BUS commands, [191](#)
 introduction to :CALIBRATE commands, [199](#)
 introduction to :CHANnel commands, [210](#)
 introduction to :DIGital commands, [228](#)
 introduction to :DISPlay commands, [235](#)
 introduction to :EXTERNAL commands, [245](#)
 introduction to :FUNCTION commands, [257](#)
 introduction to :HARDcopy commands, [273](#)
 introduction to :MARKer commands, [284](#)
 introduction to :MEASure commands, [300](#)
 introduction to :POD commands, [379](#)
 introduction to :RECall commands, [384](#)
 introduction to :SAVE commands, [391](#)
 introduction to :SBUS commands, [407](#)
 introduction to :SYSTEM commands, [433](#)
 introduction to :TIMEbase commands, [443](#)
 introduction to :TRIGger commands, [454](#)
 introduction to :WAVEform commands, [575](#)
 introduction to common (*) commands, [107](#)
 introduction to root (:) commands, [133](#)
 invert graticule colors for hardcopy, [278, 664](#)
 invert graticule colors for image, [397](#)
 inverted masks, bind levels, [372](#)

inverting input for channels, [216](#)
 IO library, referencing, [42](#)
 IP address, [31](#)
 IP Options softkey, [32](#)

K

key disable, [437](#)
 key press detected in Standard Event Status
 Register, [113](#)
 knob disable, [437](#)
 known state, [120](#)

L

label, [231, 647](#)
 label command, bus, [197](#)
 LABEL commands, [619](#)
 label list, [217, 241](#)
 labels, [217, 240, 241](#)
 labels to store calibration information, [202](#)
 labels, specifying, [235](#)
 LAN interface, [31, 34](#)
 LAN Settings softkey, [32](#)
 landscape layout for hardcopy, [279](#)
 language for program examples, [39](#)
 LaserJet, [660](#)
 layout for hardcopy, [279](#)
 leakage into peak spectrum, [271](#)
 learn string, [115, 439](#)
 least significant byte first, [581](#)
 left reference, [448](#)
 legal values for channel offset, [218](#)
 legal values for frequency span, [270](#)
 legal values for offset, [263, 266](#)
 LENGth commands, [620](#)
 length for waveform data, [404](#)
 less than qualifier, [510](#)
 less than time, [478, 481, 507, 511](#)
 LESSthan commands, [620](#)
 LEVel commands, [620](#)
 level for trigger voltage, [488, 508](#)
 LF coupling, [487](#)
 license information, [117](#)
 limits for line number, [548](#)
 LIN acknowledge, [524](#)
 LIN baud rate, [525](#)
 LIN identifier, [523](#)
 LIN serial decode bus parity bits, [424](#)
 LIN source, [526](#)
 LIN standard, [527](#)
 LIN sync break, [528](#)
 LIN trigger, [529](#)
 LIN trigger commands, [522](#)
 LIN trigger definition, [693](#)
 LIN triggering, [454](#)
 line glitch trigger source, [512](#)
 line number for TV trigger, [548](#)
 line terminator, [99](#)
 LINE trigger level, [488](#)
 LINE trigger source, [491](#)

Index

list of channel labels, 241
load utilization (CAN), 417
local lockout, 437
lock, 437
LOCK commands, 620
lock mask to signal, 363
lock, analog channel protection, 438
lockout message, 437
logic level activity, 646
long form, 742
lower threshold, 315
lower threshold voltage for measurement, 666
lowercase characters in commands, 741
low-frequency reject filter, 489
low-pass filter used to limit bandwidth, 212, 247
LRN (Learn Device Setup), 115
lsbfirst, 581

M

magnitude of occurrence, 332
main sweep range, 451
main time base, 690
main time base mode, 444
making measurements, 300
MAN option for probe sense, 651, 656
manual cursor mode, 285
MARKer commands, 283
marker mode, 291
marker position, 292
marker readout, 672, 673
marker set for voltage measurement, 678, 679
marker sets start time, 669
marker time, 668
markers for delta voltage measurement, 677
markers track measurements, 324
markers, command overview, 284
markers, mode, 285
markers, time at start, 673
markers, time at stop, 672
markers, X delta, 290
markers, X1 position, 286
markers, X1Y1 source, 287
markers, X2 position, 288
markers, X2Y2 source, 289
markers, Y delta, 293
markers, Y1 position, 291
markers, Y2 position, 292
mask, 110, 124, 462, 479
mask command, bus, 198
MASK commands, 621
mask statistics, reset, 357
mask test commands, 346
Mask Test Event Enable Register (MTEEnable), 151
mask test event event register, 153
Mask Test Event Event Register (:MTERegister[:EVENT]), 153, 726
mask test output, 364
mask test run mode, 365
mask test termination conditions, 365
mask test, enable/disable, 362
mask, delete, 361
mask, get as binary block data, 360
mask, load from binary block data, 360
mask, lock to signal, 363
mask, recall, 387
mask, save, 399
masks, bind levels, 372
master summary status bit, 127
math function, stop displaying, 140
math operations, 257
MAV (Message Available), 109, 125, 127
maximum duration, 477, 478, 507
maximum position, 445
maximum range for zoomed window, 452
maximum scale for zoomed window, 453
maximum vertical value measurement, 337
maximum vertical value, time of, 344, 670
MEASure commands, 294
measure overshoot, 313
measure period, 315
measure phase between channels, 316
measure preshoot, 317
measure start voltage, 678
measure stop voltage, 679
measure value at a specified time, 342
measure value at top of waveform, 343
measurement error, 300
measurement setup, 300, 325
measurement source, 325
measurement statistics results, 319
measurements, average value, 335
measurements, base value, 336
measurements, built-in, 41
measurements, clear, 302, 667
measurements, command overview, 300
measurements, counter, 303
measurements, dc RMS, 341
measurements, definition setup, 305
measurements, delay, 307
measurements, duty cycle, 309
measurements, fall time, 310
measurements, frequency, 311
measurements, how autoscale affects, 136
measurements, lower threshold level, 666
measurements, maximum vertical value, 337
measurements, maximum vertical value, time of, 344, 670
measurements, minimum vertical value, 338
measurements, minimum vertical value, time of, 345, 671
measurements, overshoot, 313
measurements, period, 315
measurements, phase, 316
measurements, preshoot, 317
measurements, pulse width, negative, 312
measurements, pulse width, positive, 318
measurements, ratio of AC RMS values, 340
measurements, resetting, 141
measurements, rise time, 322
measurements, show, 324
measurements, source channel, 325
measurements, standard deviation, 323
measurements, start marker time, 672
measurements, stop marker time, 673
measurements, thresholds, 669
measurements, time between start and stop markers, 668
measurements, time between trigger and edge, 330
measurements, time between trigger and vertical value, 332
measurements, time between trigger and voltage level, 674
measurements, upper threshold value, 676
measurements, vertical amplitude, 334
measurements, vertical peak-to-peak, 339
measurements, voltage difference, 677
memory setup, 123, 439
merge, 150
message available bit, 127
message available bit clear, 109
message displayed, 127
message error, 697
message queue, 716
messages ready, 127
midpoint of thresholds, 315
minimum duration, 477, 478, 481, 506
minimum vertical value measurement, 338
minimum vertical value, time of, 345, 671
mixed-signal oscilloscopes, 4
mnemonics, duplicate, 758
mode, 179, 188, 285, 444, 549
MODE commands, 622
mode, serial decode, 425
model number, 114
models, oscilloscope, 3
modes for triggering, 460
Modify softkey, 32
monochrome palette for image, 398
most significant byte first, 581
move, 257
move cursors, 672, 673
msbfirst, 581
MSG (Message), 125, 127
MSO models, 4
MSS (Master Summary Status), 127
MTEEnable (Mask Test Event Enable Register), 151
MTERegister[:EVENT] (Mask Test Event Event Register), 153, 726
MTESt commands, 346
multiple commands, 759
multiple queries, 49
multiply math function, 257, 264, 595
multiply math function as g(t) source, 260

N

name channels, 217
name list, 241
negative glitch trigger polarity, 509
negative pulse width, 312
negative pulse width measurement, 41

negative slope, [490, 539](#)
 negative slope, Nth edge in burst, [485](#)
 negative TV trigger polarity, [550](#)
 new line (NL) terminator, [99, 742](#)
 NL (new line) terminator, [99, 742](#)
 noise reject filter, [461](#)
 non-core commands, [740](#)
 non-interlaced GENeric mode, [552](#)
 non-volatile memory, label list, [197, 231, 241](#)
 normal acquisition type, [174, 575](#)
 normal trigger sweep mode, [454](#)
 notices, [2](#)
 NR1 number format, [99](#)
 NR3 number format, [99](#)
 Nth edge in a burst idle, [484](#)
 Nth edge in burst slope, [485](#)
 Nth edge of burst counter, [483](#)
 NTSC, [548, 552](#)
 null frame count (FlexRay), [419](#)
 NULL string, [435](#)
 number format, [99](#)
 number of points, [180, 586, 588](#)
 number of time buckets, [586, 588](#)
 numeric variables, [48](#)
 numeric variables, reading query results into multiple, [50](#)
 nwidth, [312](#)

O

obsolete and discontinued commands, [641](#)
 obsolete commands, [740](#)
 occurrence reported by magnitude, [674](#)
 offset, [257](#)
 OFFSet commands, [624](#)
 offset value for channel voltage, [218](#)
 offset value for selected function, [263, 266](#)
 one values in waveform data, [583](#)
 OPC (Operation Complete) command, [116](#)
 OPC (Operation Complete) status bit, [111, 113](#)
 OPEE (Operation Status Enable Register), [155](#)
 Open method, [43](#)
 operating configuration, [115, 439](#)
 operating state, [123](#)
 OPERation commands, [624](#)
 operation complete, [116](#)
 operation status condition register, [157](#)
 Operation Status Condition Register (:OPERRegister:CONDition), [157, 721](#)
 operation status conditions occurred, [127](#)
 Operation Status Enable Register (OPEE), [155](#)
 operation status event register, [159](#)
 Operation Status Event Register (:OPERRegister[:EVENT]), [159, 720](#)
 operation, math, [257](#)
 operations for function, [264](#)
 OPERRegister:CONDition (Operation Status Condition Register), [157, 721](#)
 OPERRegister[:EVENT] (Operation Status Event Register), [159, 720](#)
 OPT (Option Identification), [117](#)
 optional syntax terms, [99](#)

options, [117](#)
 order of digital channels on display, [653](#)
 order of output, [581](#)
 oscilloscope connection, opening, [43](#)
 oscilloscope connection, verifying, [33](#)
 oscilloscope external trigger, [245](#)
 oscilloscope models, [3](#)
 oscilloscope rate, [187](#)
 oscilloscope, connecting, [31](#)
 oscilloscope, initialization, [40](#)
 oscilloscope, operation, [4](#)
 oscilloscope, program structure, [40](#)
 oscilloscope, setting up, [31](#)
 oscilloscope, setup, [44](#)
 OUTPut commands, [624](#)
 output messages ready, [127](#)
 output queue, [116, 715](#)
 output queue clear, [109](#)
 output sequence, [581](#)
 output, mask test, [364](#)
 overlapped commands, [762](#)
 overload, [223, 252](#)
 Overload Event Enable Register (OVL), [161](#)
 Overload Event Register (:OVLRegister), [723](#)
 Overload Event Register (OVLr), [163](#)
 overload frame count (CAN), [414](#)
 overload protection, [161, 163](#)
 overshoot of waveform, [313](#)
 overvoltage, [223, 252](#)
 OVL (Overload Event Enable Register), [161](#)
 OVLr (Overload Event Register), [163](#)
 OVLr bit, [148, 157, 159](#)
 OVLRegister (Overload Event Register), [723](#)

P

P1080L24HZ, [548, 552](#)
 P1080L25HZ, [548, 552](#)
 P480L60HZ, [548, 552](#)
 P720L60HZ, [548, 552](#)
 PAL, [548, 552](#)
 PAL-M, [548, 552](#)
 PAlLette commands, [624](#)
 palette for hardcopy, [280](#)
 palette for image, [398](#)
 parameters for delay measurement, [307](#)
 parametric measurements, [300](#)
 parity, [561](#)
 parity bits, LIN serial decode bus, [424](#)
 PARity commands, [624](#)
 parser, [133, 759](#)
 pass (mask test) output, [364](#)
 pass, self test, [129](#)
 path information, recall, [388](#)
 path information, save, [400](#)
 pattern, [462, 467, 469, 479, 514, 515, 516, 534, 542](#)
 pattern and edge, [462](#)
 PATtern commands, [624](#)
 pattern duration, [477, 478, 506, 507](#)
 pattern length, [468](#)
 pattern trigger, [462](#)
 pattern triggering, [454](#)
 pattern width, [543](#)
 peak detect, [188](#)
 peak detect acquisition type, [174, 575](#)
 peaks, [257](#)
 peak-to-peak vertical value measurement, [339](#)
 pending operations, [116](#)
 percent of waveform overshoot, [313](#)
 percent thresholds, [305](#)
 period measured to calculate phase, [316](#)
 period measurement, [41, 300, 315](#)
 persistence, waveform, [235, 242](#)
 phase measured between channels, [316](#)
 phase measurements, [330](#)
 pixel memory, [243](#)
 pixel memory, saving display to, [150](#)
 PLL Locked bit, [146, 157](#)
 pod, [379, 380, 381, 382, 595, 648](#)
 POD commands, [379](#)
 pod, stop displaying, [140](#)
 points, [180, 586, 588](#)
 POINts commands, [625](#)
 points in waveform data, [575](#)
 polarity, [550, 562](#)
 POLarity commands, [625](#)
 polarity for glitch trigger, [509](#)
 polling synchronization with timeout, [732](#)
 polling wait, [730](#)
 PON (Power On) status bit, [111, 113](#)
 portrait layout for hardcopy, [279](#)
 position, [232, 288, 445, 451](#)
 POSition commands, [625](#)
 position cursors, [672, 673](#)
 position in zoomed view, [451](#)
 position waveforms, [653](#)
 positive glitch trigger polarity, [509](#)
 positive pulse width, [318](#)
 positive pulse width measurement, [41](#)
 positive slope, [490, 539](#)
 positive slope, Nth edge in burst, [485](#)
 positive TV trigger polarity, [550](#)
 positive width, [318](#)
 preamble data, [575, 590](#)
 predefined logic threshold, [648](#)
 predefined threshold voltages, [694](#)
 present working directory, recall operations, [388](#)
 present working directory, save operations, [400](#)
 preset conditions, [120](#)
 preshoot measured on waveform, [317](#)
 previously stored configuration, [119](#)
 print command, [165](#)
 print job, start, [282](#)
 print mask test failures, [366](#)
 print query, [688](#)
 printer, [660](#)
 printer driver for hardcopy, [665](#)
 printer hardcopy format, [662](#)
 printer, active, [275](#)
 printing, [273](#)
 printing in grayscale, [663](#)
 probe, [488](#)

Index

probe attenuation affects channel voltage range, 224
probe attenuation factor (external trigger), 249
probe attenuation factor for selected channel, 219
PROBe commands, 625
probe ID, 220, 250
probe sense for oscilloscope, 651, 656
probe skew value, 221, 649
process sigma, mask test run, 369
program data, 742
program data syntax rules, 744
program initialization, 40
program message, 43, 107
program message syntax, 741
program message terminator, 742
program structure, 40
programming examples, 4, 763
protecting against calibration, 206
protection, 161, 163, 223, 252
PROTection commands, 625
protection lock, 438
pulse width, 312, 318
pulse width duration trigger, 506, 507, 511
pulse width measurement, 41, 300
pulse width trigger, 461
pulse width trigger level, 508
pulse width triggering, 454
PWD commands, 626
pwidth, 318

Q

qualifier, 511
QUALifier commands, 626
qualifier, trigger duration, 477, 478, 480
queries, multiple, 49
query error detected in Standard Event Status, 113
query responses, block data, 48
query responses, reading, 47
query results, reading into numeric variables, 48
query results, reading into string variables, 48
query return values, 761
query setup, 273, 284, 300, 439
query subsystem, 191, 228, 257
querying setup, 210
querying the subsystem, 454
queues, clearing, 727
quick reference, commands, 53
quoted ASCII string, 100
QYE (Query Error) status bit, 111, 113

R

range, 257, 452
RANGe commands, 626
range for channels, 224
range for duration trigger, 481
range for external trigger, 253

range for full-scale vertical axis, 265
range for glitch trigger, 511
range for time base, 446
range of offset values, 218
range qualifier, 510
ranges, value, 100
rate, 187
ratio of AC RMS values measured between channels, 340
RCL (Recall), 119
read configuration, 115
read trace memory, 238
ReadIIEEEBlock method, 43, 47, 49
ReadList method, 43, 47
ReadNumber method, 43, 47
readout, 668
ReadString method, 43, 47
real-time acquisition mode, 174, 179
recall, 119, 384, 439
RECall commands, 384
recall filename, 385
recall image, 386
recall mask, 387
recall path information, 388
recall setup, 389
recalling and saving data, 235
RECTangular window for transient signals, 271
reference, 257, 448
reference clock, 447
REFeRence commands, 626
reference for time base, 690
reference signal (10 MHz), 181
reference signal mode, 447
registers, 112, 119, 123, 135, 144, 146, 148, 151, 153, 155, 157, 159, 161, 163
registers, clearing, 727
reject filter, 489
reject high frequency, 458
reject noise, 461
remote control examples, 763
remove cursor information, 285
remove labels, 240
remove message from display, 435
reorder channels, 136
repetitive acquisitions, 166
report errors, 436
report transition, 330, 332
reporting status, 705
reporting the setup, 454
request service, 127
Request-for-OPC flag clear, 109
reset, 120, 535
RESet commands, 626
reset conditions, 120
reset mask statistics, 357
reset measurements, 141, 237
resolution of printed copy, 663
resource session object, 43
ResourceManager object, 43
restore configurations, 115, 119, 123, 439
restore labels, 240
restore setup, 119

return values, query, 761
returning acquisition type, 188
returning number of data points, 180
right reference, 448
rise time measurement, 300
rise time of positive edge, 322
rising edge, 462, 532
RMODe commands, 627
RMS value measurement, 341
roll time base mode, 444
root (:) commands, 131, 133
root level commands, 104
RQL (Request Control) status bit, 111, 113
RQS (Request Service), 127
RST (Reset), 120
rules, tree traversal, 759
rules, truncation, 742
RUMode commands, 627
run, 128, 166
Run bit, 157, 159
run mode, mask test, 365
running configuration, 123, 439
Rx frame count (UART), 430
Rx source, 564

S

sample rate, 187
sampled data, 652
sampled data points, 583
SAMPlEpoint commands, 627
SAV (Save), 123
save, 123, 391
SAVE commands, 390, 627
save filename, 392
save image, 393
save image with inksaver, 397
save mask, 399
save mask test failures, 367
save path information, 400
save setup, 401
SAVE TO INTERN, 150
save waveform data, 402
save waveforms to pixel memory, 150
saved image, area, 394
saving and recalling data, 235
SBUS commands, 406
scale, 267, 449, 453
SCALe commands, 628
scale factors output on hardcopy, 276, 395
scale for channels, 225
scale units for channels, 226
scale units for external trigger, 254
scaling display factors, 219
SCPI commands, 51
scratch measurements, 667
screen area for hardcopy print, 274
screen area for saved image, 394
screen data, 238
SECAM, 548, 552
seconds per division, 449
segment, FLEXYray time trigger, 501

- SEGmented commands, 629
- segmented waveform save option, 405
- segments, analyze, 182
- segments, count of waveform, 593
- segments, setting number of memory, 183
- segments, setting the index, 184
- segments, time tag, 594
- select measurement channel, 325
- self-test, 129
- sensing a channel probe, 651
- sensing a external trigger probe, 656
- sensitivity of oscilloscope input, 219
- sequence, 533, 534, 535
- sequence trigger, 537
- SEquence trigger commands, 530
- sequence triggering, 454
- sequencer edge counter, 531
- sequencer timer, 536
- sequential commands, 762
- serial clock, 517, 544
- serial data, 518, 545
- serial decode bus, 407
- serial decode bus display, 418
- serial decode mode, 425
- serial frame, 546
- serial number, 167
- service request, 127
- Service Request Enable Register (SRE), 125, 713
- set, 120
- set center frequency, 258
- set conditions, 136
- set cursors, 672, 673
- set date, 434
- set delay, 136
- set thresholds, 136
- set time, 441
- set time/div, 136
- set up oscilloscope, 31
- setting digital display, 230
- setting digital label, 197, 231
- setting digital position, 232
- setting digital threshold, 234
- setting display, 259
- setting external trigger level, 245
- setting impedance for channels, 215
- setting inversion for channels, 216
- setting pod display, 380
- setting pod size, 381
- setting pod threshold, 382
- settings, 119, 123
- settings, instrument, 273
- setup, 174, 191, 210, 228, 235, 257, 273, 439
- SETup commands, 629
- setup configuration, 119, 123, 439
- setup defaults, 120
- setup memory, 119
- setup reported, 454
- setup, recall, 389
- setup, save, 401
- short form, 3, 742
- show channel labels, 240
- show measurements, 300, 324
- SICL example in C, 764
- SICL example in Visual Basic, 773
- SICL examples, 764
- sigma, mask test run, 369
- SIGNal commands, 629
- signal type, 222, 251
- simple command headers, 743
- single acquisition, 168
- single-ended signal type, 222, 251
- single-shot DUT, synchronizing with, 734
- size, 233, 381
- SIZE commands, 629
- skew, 221, 649
- slope, 490, 539
- slope (direction) of waveform, 674
- SLOPe commands, 630
- slope not valid in TV trigger mode, 490
- slope of edge, 532
- slope parameter for delay measurement, 307
- slope, Nth edge in burst, 485
- software version, 114
- source, 243, 257, 325, 473, 526, 595
- SOURce commands, 630
- source for function, 268, 269, 657
- source for trigger, 491
- source for TV trigger, 551
- source, automask, 352
- source, mask test, 377
- SOURce1 commands, 630
- SOURce2 commands, 630
- span, 257
- span of frequency on display, 270
- specify measurement, 325
- SPI, 539, 540, 542
- SPI commands, 631
- SPI decode word width, 426
- SPI trigger, 541, 543
- SPI trigger clock, 544
- SPI trigger commands, 538
- SPI trigger data, 545
- SPI trigger frame, 546
- SPI triggering, 454
- square root math function, 264
- SRE (Service Request Enable Register), 125, 713
- SRQ (Service Request interrupt), 144, 151, 155
- STANdard commands, 631
- standard deviation measured on waveform, 323
- Standard Event Status Enable Register (ESE), 110, 718
- Standard Event Status Register (ESR), 112, 717
- standard for video, 552
- standard, LIN, 527
- start acquisition, 128, 142, 166, 168
- start and stop edges, 305
- STARt commands, 631
- start cursor, 672
- start measurement, 300
- start print job, 282
- start time, 511, 672
- start time marker, 669
- state memory, 123
- state of instrument, 115, 439
- STATistics commands, 631
- statistics increment, 328
- statistics reset, 329
- statistics results, 319
- statistics, type of, 327
- status, 126, 169, 171
- Status Byte Register (STB), 124, 126, 127, 711
- STATus commands, 631
- status data structure clear, 109
- status registers, 50
- status reporting, 705
- STB (Status Byte Register), 124, 126, 127, 711
- step size for frequency span, 270
- stop, 142, 170
- stop acquisition, 170
- STOP commands, 631
- stop cursor, 673
- stop displaying channel, 140
- stop displaying math function, 140
- stop displaying pod, 140
- stop on mask test failure, 368
- stop time, 511, 673
- storage, 123
- store instrument setup, 115, 123
- store setup, 123
- store waveforms to pixel memory, 150
- storing calibration information, 202
- string variables, 48
- string variables, reading multiple query results into, 49
- string variables, reading query results into multiple, 49
- string, quoted ASCII, 100
- subnet mask, 31
- subsource, waveform source, 599
- subsystem commands, 104, 759
- subtract math function, 257, 264, 595
- subtract math function as g(t) source, 260
- sweep mode, trigger, 454, 464
- sweep speed set to fast to measure fall time, 310
- sweep speed set to fast to measure rise time, 322
- switch disable, 437
- switch, calibration protect, 206
- sync break, LIN, 528
- sync frame count (FlexRay), 421
- syntax elements, 99
- syntax rules, program data, 744
- syntax, optional terms, 99
- syntax, program message, 741
- SYSTem commands, 433
- system commands, 434, 435, 436, 437, 439, 441
- system commands introduction, 433

T

tdelta, 668

Index

- tedge, 330
- telnet ports 5024 and 5025, 583
- Telnet sockets, 51
- temporary message, 435
- TER (Trigger Event Register), 171, 714
- termination conditions, mask test, 365
- test sigma, mask test run, 369
- test, self, 129
- text, writing to display, 435
- threshold, 234, 382, 648, 694
- THReshold commands, 632
- threshold voltage (lower) for measurement, 666
- threshold voltage (upper) for measurement, 676
- thresholds, 305, 669
- thresholds used to measure period, 315
- thresholds, how autoscale affects, 136
- TIFF image format, 396
- time base, 444, 445, 446, 448, 449, 690
- time base commands introduction, 443
- time base reset conditions, 120
- time base window, 451, 452, 453
- time between points, 668
- time buckets, 176, 177
- TIME commands, 632
- time delay, 690
- time delta, 668
- time difference between data points, 603
- time duration, 477, 478, 481, 511
- time holdoff for trigger, 459
- time interval, 330, 332, 668
- time interval between trigger and occurrence, 674
- time marker sets start time, 669
- time per division, 446
- time record, 271
- time slot, FLEXray time trigger, 502
- time specified, 342
- time, calibration, 208
- time, mask test run, 370
- time, start marker, 672
- time, stop marker, 673
- time, system, 441
- time/div, how autoscale affects, 136
- time-at-max measurement, 670
- time-at-min measurement, 671
- TIMEbase commands, 442
- timebase vernier, 450
- TIMEbase:MODE, 46
- time-ordered label list, 241
- timeout, 540
- timer, 536
- timing measurement, 300
- title channels, 217
- title, mask test, 378
- tolerance, automask, 354, 355
- top of waveform value measured, 343
- TOTAL commands, 633
- total frame count (CAN), 416
- total frame count (FlexRay), 422
- total waveforms in mask test, 359
- trace memories, how autoscale affects, 136
- trace memory, 169, 172
- trace memory data, 238
- track measurements, 324
- trademarks, 2
- transfer instrument state, 115, 439
- transmit, 238
- tree traversal rules, 759
- tree, command, 745
- TRG (Trigger), 125, 127, 128
- TRIG OUT BNC, 203
- trigger (external) input impedance, 248, 655
- trigger armed event register, 157, 159
- trigger burst, UART, 558
- TRIGger CAN commands, 465
- trigger channel source, 512, 551
- TRIGger commands, 454, 633
- TRIGger commands, general, 457
- trigger data, UART, 559
- trigger duration, 477, 478
- TRIGger DURation commands, 476
- TRIGger EBUrst commands, 482
- trigger edge, 532
- TRIGger EDGE commands, 486
- trigger edge coupling, 487
- trigger edge slope, 490
- trigger event bit, 171
- Trigger Event Register (TER), 714
- TRIGger FLEXray commands, 492
- TRIGger GLITCh commands, 504
- trigger holdoff, 459
- trigger idle, UART, 560
- TRIGger IIC commands, 513
- trigger level constants, 219
- trigger level voltage, 488
- TRIGger LIN commands, 522
- trigger occurred, 127
- trigger pattern, 462, 479
- trigger qualifier, 480
- trigger qualifier, UART, 563
- trigger reset conditions, 120
- TRIGger SEQuence commands, 530
- trigger SPI clock slope, 539
- TRIGger SPI commands, 538
- trigger status bit, 171
- trigger sweep mode, 454
- TRIGger TV commands, 547
- trigger type, UART, 566
- TRIGger UART commands, 553
- TRIGger USB commands, 568
- trigger, CAN, 474
- trigger, CAN acknowledge, 691
- trigger, CAN pattern data, 467
- trigger, CAN pattern data length, 468
- trigger, CAN pattern ID, 469
- trigger, CAN pattern ID mode, 470
- trigger, CAN sample point, 471
- trigger, CAN signal baudrate, 472
- trigger, CAN signal definition, 692
- trigger, CAN source, 473
- trigger, duration greater than, 477
- trigger, duration less than, 478
- trigger, duration pattern, 479
- trigger, duration qualifier, 480
- trigger, duration range, 481
- trigger, edge coupling, 487
- trigger, edge level, 488
- trigger, edge reject, 489
- trigger, edge slope, 490
- trigger, edge source, 491
- trigger, FLEXray, 503
- trigger, FLEXray error, 493
- trigger, glitch greater than, 506
- trigger, glitch less than, 507
- trigger, glitch level, 508
- trigger, glitch polarity, 509
- trigger, glitch qualifier, 510
- trigger, glitch range, 511
- trigger, glitch source, 512
- trigger, high frequency reject filter, 458
- trigger, holdoff, 459
- trigger, IIC clock source, 517
- trigger, IIC data source, 518
- trigger, IIC pattern address, 514
- trigger, IIC pattern data, 515
- trigger, IIC pattern data 2, 516
- trigger, IIC qualifier, 519
- trigger, IIC signal baudrate, 525
- trigger, IIC type, 520
- trigger, LIN, 529
- trigger, LIN sample point, 524
- trigger, LIN signal definition, 693
- trigger, LIN source, 526
- trigger, mode, 460
- trigger, noise reject filter, 461
- trigger, Nth edge in burst slope, 485
- trigger, Nth edge of burst count, 483
- trigger, pattern, 462
- trigger, sequence, 537
- trigger, sequence count, 531
- trigger, sequence edge, 532
- trigger, sequence find, 533
- trigger, sequence pattern, 534
- trigger, sequence reset, 535
- trigger, sequence timer, 536
- trigger, SPI clock slope, 539
- trigger, SPI clock source, 544
- trigger, SPI clock timeout, 540
- trigger, SPI data source, 545
- trigger, SPI frame source, 546
- trigger, SPI framing, 541
- trigger, SPI pattern data, 542
- trigger, SPI pattern width, 543
- trigger, sweep, 464
- trigger, threshold, 694
- trigger, TV line, 548
- trigger, TV mode, 549, 695
- trigger, TV polarity, 550
- trigger, TV source, 551
- trigger, TV standard, 552
- trigger, UART base, 555
- trigger, UART baudrate, 556
- trigger, UART bit order, 557
- trigger, UART parity, 561

trigger, UART polarity, 562
 trigger, UART Rx source, 564
 trigger, UART Tx source, 565
 trigger, UART width, 567
 trigger, USB, 572
 trigger, USB D- source, 569
 trigger, USB D+ source, 570
 trigger, USB speed, 571
 truncation rules, 742
 TST (Self Test), 129
 tstart, 672
 tstop, 673
 TTL threshold voltage for digital channels, 234, 648
 TTL trigger threshold voltage, 694
 turn function on or off, 658
 turn off channel, 140
 turn off channel labels, 240
 turn off cursors, 136
 turn off digital pod, 140
 turn off math function, 140
 turn off measurements, 136
 turn off trace memories, 136
 turn off zoomed time base mode, 136
 turn on channel labels, 240
 turn on channel number display, 653
 turn on channels, 136
 turning channel display on and off, 214
 turning off/on function calculation, 259
 turning vectors on or off, 652
 TV mode, 549, 695
 TV trigger commands, 547
 TV trigger line number setting, 548
 TV trigger mode, 551
 TV trigger polarity, 550
 TV trigger standard setting, 552
 TV triggering, 454
 tvmode, 695
 Tx data, UART, 599
 Tx frame count (UART), 431
 Tx source, 565
 type, 188, 600
 TYPE commands, 636

U

UART base, 555
 UART baud rate, 556
 UART bit order, 557
 UART commands, 637
 UART frame counters, reset, 429
 UART parity, 561
 UART polarity, 562
 UART Rx source, 564
 UART trigger burst, 558
 UART trigger commands, 553
 UART trigger data, 559
 UART trigger idle, 560
 UART trigger qualifier, 563
 UART trigger type, 566
 UART Tx data, 599
 UART Tx source, 565

UART width, 567
 UNITs commands, 637
 units per division, 225, 226, 254, 449
 units per division (vertical) for function, 225, 267
 units, automask, 353
 unsigned mode, 601
 upper threshold, 315
 upper threshold voltage for measurement, 676
 uppercase characters in commands, 741
 URQ (User Request) status bit, 111, 113
 USB (Device) interface, 31
 USB source, 569, 570
 USB speed, 571
 USB trigger, 572
 USB trigger commands, 568
 USB triggering, 454
 user defined channel labels, 217
 user defined threshold, 648
 user event conditions occurred, 127
 User's Guide, 4
 user-defined threshold voltage for digital channels, 234
 user-defined trigger threshold, 694
 USR (User Event bit), 125, 127
 Utility button, 31, 32
 utilization, CAN bus, 417

V

valid command strings, 741
 valid pattern time, 477, 478
 value, 332
 value measured at base of waveform, 336
 value measured at specified time, 342
 value measured at top of waveform, 343
 value ranges, 100
 values required to fill time buckets, 177
 VBA, 42, 828
 vectors, 244
 vectors turned on or off, 652
 vectors, turning on or off, 235
 vernier, channel, 227
 vernier, horizontal, 450
 vertical adjustment, fine (vernier), 227
 vertical amplitude measurement, 334
 vertical axis defined by RANGe, 265
 vertical axis range for channels, 224
 vertical offset for channels, 218
 vertical peak-to-peak measured on waveform, 339
 vertical scale, 225, 267
 vertical scaling, 590
 vertical threshold, 648
 vertical value at center screen, 263, 266
 vertical value maximum measured on waveform, 337
 vertical value measurements to calculate overshoot, 313
 vertical value minimum measured on waveform, 338
 video line to trigger on, 548

video standard selection, 552
 view, 172, 257, 602, 653
 view turns function on or off, 658
 VISA COM example in C#, 838
 VISA COM example in Visual Basic, 828
 VISA COM example in Visual Basic .NET, 849
 VISA example in C, 782
 VISA example in C#, 801
 VISA example in Visual Basic, 791
 VISA example in Visual Basic .NET, 815
 VISA examples, 782, 828
 Visual Basic .NET, VISA COM example, 849
 Visual Basic .NET, VISA example, 815
 Visual Basic 6.0, 43
 Visual Basic for Applications, 42, 828
 Visual Basic, SICL library example, 773
 Visual Basic, VISA COM example, 828
 Visual Basic, VISA example, 791
 voltage crossing reported or not found, 674
 voltage difference between data points, 606
 voltage difference measured, 677
 voltage level for active trigger, 488
 voltage marker used to measure waveform, 678, 679
 voltage offset value for channels, 218
 voltage probe, 226, 254
 voltage ranges for channels, 224
 voltage ranges for external trigger, 253
 voltage threshold, 305

W

WAI (Wait To Continue), 130
 wait, 130
 wait for operation complete, 116
 Wait Trig bit, 157, 159
 waveform base value measured, 336
 WAVEform command, 41
 WAVEform commands, 573, 638
 waveform data, 575
 waveform data format, 403
 waveform data length, 404
 waveform data, save, 402
 waveform introduction, 575
 waveform maximum vertical value measured, 337
 waveform minimum vertical value measured, 338
 waveform must cross voltage level to be an occurrence, 674
 WAVEform parameters, 46
 waveform peak-to-peak vertical value measured, 339
 waveform period, 315
 waveform persistence, 235
 waveform RMS value measured, 341
 waveform save option for segments, 405
 waveform source channels, 595
 waveform source subsource, 599
 waveform standard deviation value measured, 323
 waveform vertical amplitude, 334

Index

- waveform voltage measured at marker, [678](#), [679](#)
- waveform, byte order, [581](#)
- waveform, count, [582](#)
- waveform, data, [583](#)
- waveform, format, [585](#)
- waveform, points, [586](#), [588](#)
- waveform, preamble, [590](#)
- waveform, source, [595](#)
- waveform, type, [600](#)
- waveform, unsigned, [601](#)
- waveform, view, [602](#)
- waveform, X increment, [603](#)
- waveform, X origin, [604](#)
- waveform, X reference, [605](#)
- waveform, Y increment, [606](#)
- waveform, Y origin, [607](#)
- waveform, Y reference, [608](#)
- WAVeform:FORMat, [46](#)
- WAVeforms commands, [639](#)
- waveforms, mask test run, [371](#)
- Web control, [51](#)
- what's new, [21](#)
- width, [511](#), [567](#)
- WIDTh commands, [639](#)
- window, [451](#), [452](#), [453](#)
- window time, [446](#)
- window time base mode, [444](#)
- windows, [271](#)
- windows as filters to Fast Fourier Transforms, [271](#)
- windows for Fast Fourier Transform functions, [271](#)
- word format, [585](#)
- word format for data transfer, [575](#)
- word width, SPI decode, [426](#)
- write text to display, [435](#)
- write trace memory, [238](#)
- WriteIEEEBlock method, [43](#), [49](#)
- WriteList method, [43](#)
- WriteNumber method, [43](#)
- WriteString method, [43](#)

X

- X axis markers, [284](#)
- X delta, [290](#)
- X delta, mask scaling, [374](#)
- X1 and X2 cursor value difference, [290](#)
- X1 cursor, [284](#), [286](#), [287](#)
- X1, mask scaling, [373](#)
- X2 cursor, [284](#), [288](#), [289](#)
- X-axis functions, [443](#)
- XDELta commands, [639](#)
- X-increment, [603](#)
- X-of-max measurement, [344](#)
- X-of-min measurement, [345](#)
- X-origin, [604](#)
- X-reference, [605](#)
- X-Y mode, [443](#), [444](#)

Y

- Y axis markers, [284](#)
- Y1 and Y2 cursor value difference, [293](#)
- Y1 cursor, [284](#), [287](#), [291](#), [293](#)
- Y1, mask scaling, [375](#)
- Y2 cursor, [284](#), [289](#), [292](#), [293](#)
- Y2, mask scaling, [376](#)
- Y-axis value, [607](#)
- YDELta commands, [639](#)
- Y-increment, [606](#)
- Y-origin, [607](#), [608](#)
- Y-reference, [608](#)

Z

- zero values in waveform data, [583](#)
- zoomed time base, [444](#)
- zoomed time base mode, how autoscale affects, [136](#)
- zoomed window horizontal scale, [453](#)